

60c ■ MAR. 1967

Radio-Electronics

TELEVISION · SERVICING · HIGH FIDELITY

HUGO GERNSBACK, Editor-in-chief

A
GERNSBACK
PUBLICATION

SPECIAL ISSUE
SOLID STATE
 Microelectronics



CASA DEL GIORNALE
 700---001.67

NEW! LOW-COST
Color VTR

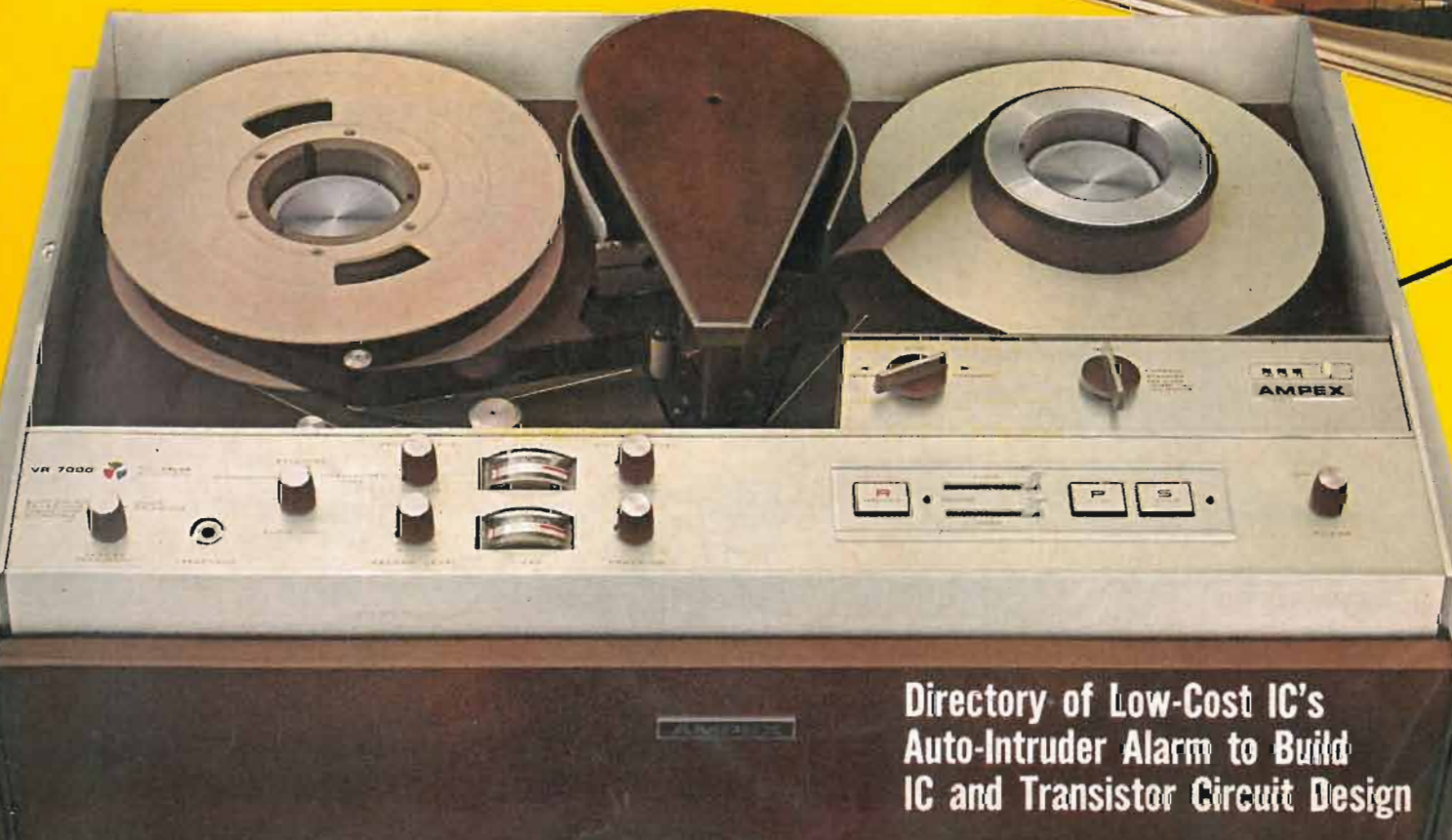

Directory of Low-Cost IC's
 Auto-Intruder Alarm to Build
 IC and Transistor Circuit Design

If you think
all replacement tubes are alike
you've got a surprise coming

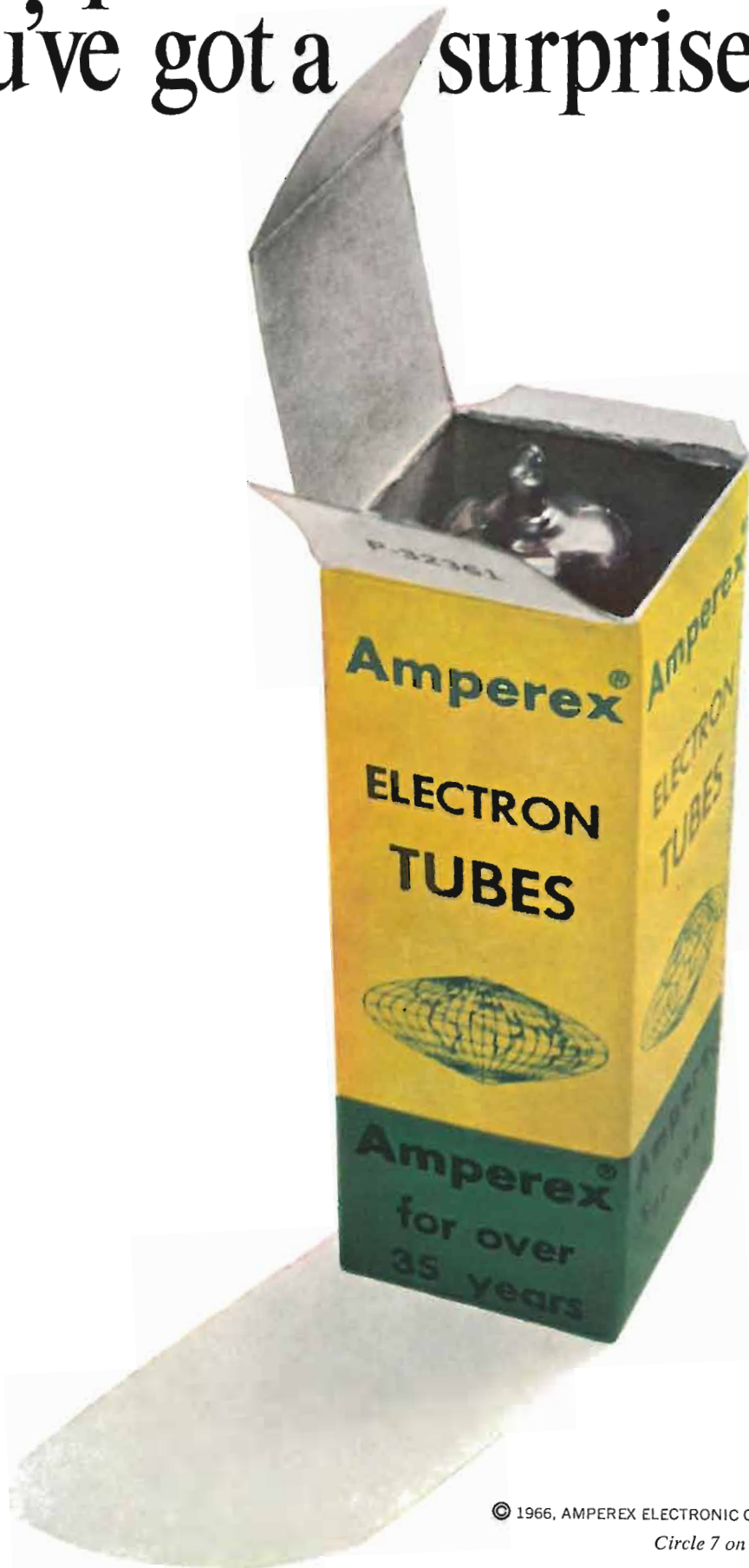

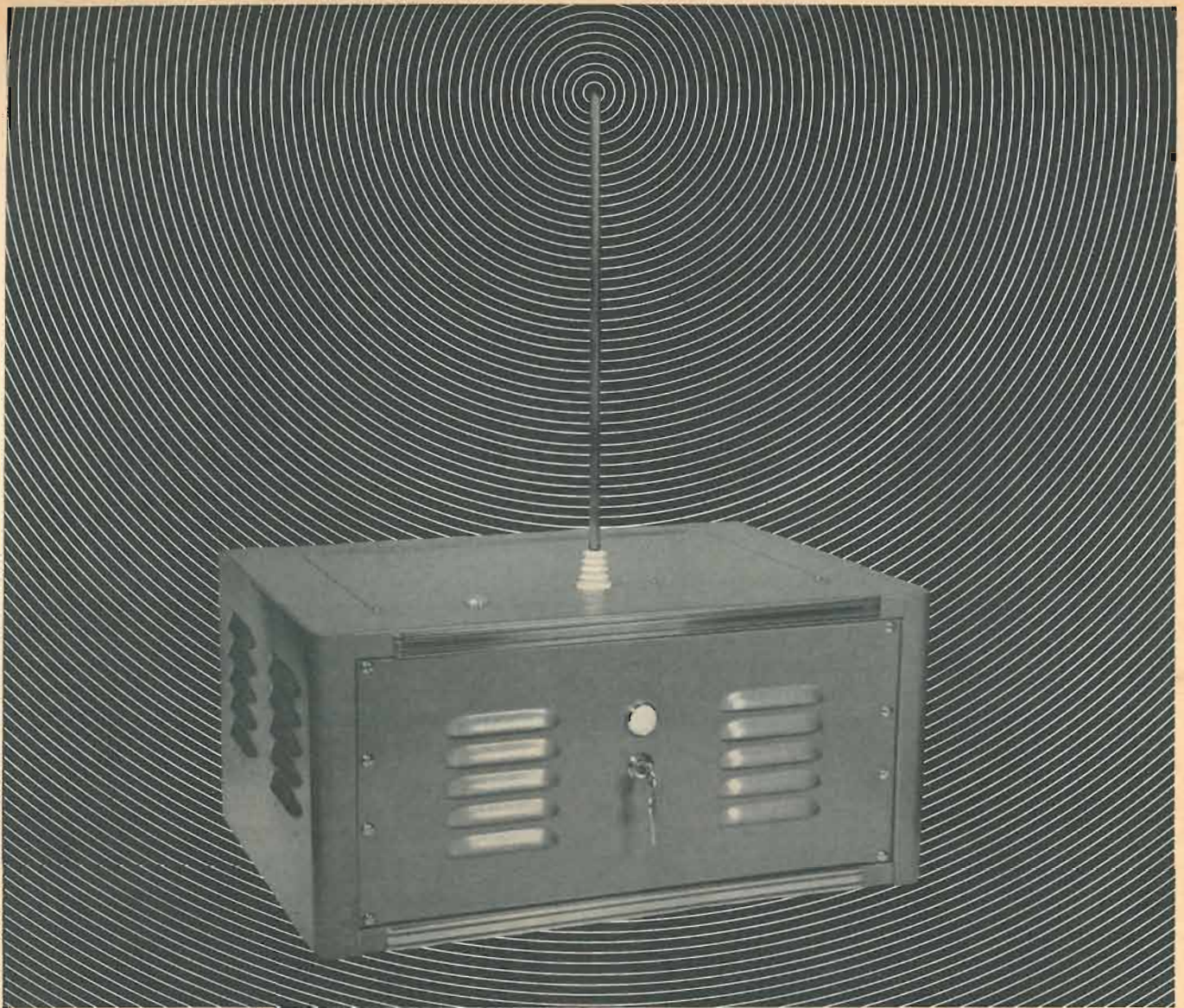

You are now in Radar Sentry Alarm's r.f. microwave field. Don't move a muscle!

This security system is so sensitive, it can be adjusted to detect the motion of your arm turning this page.

And if this Portable Model Unit were within 35 feet of you and you moved... people up to a half-mile away could hear the siren. Plus with optional equipment, it can detect fire... turn on lights... even notify police.

What does a burglar alarm have to do with you?

Just this: Radar Sentry is no ordinary alarm. It is the most modern and effective security system available. And it's also electronic.

That's why we need you. We need Dealers with technical knowledge. For the most successful Dealers for Radar Sentry Alarm are men who know electronics. This is a product that sells itself when demonstrated properly.

It's been proven time after time. In fact, many of the more than one thousand readers of electronics magazines who became Dealers in the past year—sold a system on their *first* demonstration.

And that's why we need men with technical knowledge and experience.

Men like you.

How about it?

Do you want to start a business of your own... or expand your present business with a product that in 8 years has become the world-wide leader in its field?

Do you want to earn up to \$5,000 a year in your spare time?

Do you want to earn \$20,000 and more full time?

We'll show you how.

O.K., now you can move.

Fill out the coupon and get complete Dealer/Distributor information... free.

Mail to: RADAR DEVICES MANUFACTURING CORP.
22003 Harper Ave., St. Clair Shores, Michigan 48080

RE-3



Please tell me how I can have a business of my own distributing Radar Sentry Alarm Systems. I understand there is no obligation.

Name _____

Address _____

City _____ State & Code _____

Can Electronics Get Much Smaller?

IT is easier for a camel to go through the eye of a needle" That doesn't sound easy at all, nor was it intended to. We're getting closer and closer every day to trying it in electronic miniaturization. It seems we're reaching the hump, however, and it's time we took a look at what to do next.

There are practical limits to just how small electronic devices can become. At least, there seem to be.

For example, the electronics of a low-powered two-way radio can go on a chip no larger than the head of a pin, but the microphone and speaker require many times that space—their size determines how small a personal communications system can be.

For example, the electronics for an AM-FM tuner and the i.f. strips can be put inside a module no larger than a pilot lamp, and another silicon chip added to it can provide the entire multiplex decoder for FM stereo. But what about the tuned circuits and—more important—the dial itself? Imagine trying to spread 10, 20, or 30 FM stations around the small circumference of that lamp.

For example, the electronics of a stereo preamp can be put in a thimble. But, then, who could adjust the volume, tone, loudness, balance, etc.? Even if controls were miniscule, you'd still need knobs large enough to get a thumb and finger on.

Other limitations are inherent in microelectronics itself. Capacitances of any large size are still very expensive, if not impossible. A watt is a watt, and even at high efficiency there is still plenty of power lost as heat that must be dissipated. Power supplies, even batteries, take up disproportionate space.

Is this the limit of size reduction? Have we reached the ultimate in miniaturizing electronic systems? Not likely. There are still many ways to overcome the present limitations—all that is required is a little different thinking. Here are some examples of what is already in sight.

As efficiencies go higher and higher, a watt of dc

power will be converted into almost a full watt of signal power or acoustic power. Result: virtually no heat waste. With efficiency so high, supertiny batteries will last indefinitely and be continually recharged by microscopic cells activated by daylight or artificial light.

Tiny solid-state tuned filters will take the place of bulky LC circuits. Touch-controlled variable tuning and small luminescent cubes with station numbers will replace huge tuning dials. Touch switching, gate-controlled on IC chips, will take the place of panel controls as we know them today.

There will be no need for wiring. An IC transmitter in the stereo cartridge of your turntable will send the sound signals directly to a receiver chip in your preamplifier. Ditto from the preamp to high-efficiency speakers, two small squares that resemble wallpaper, each with its own tiny power amplifier.

You will be able to carry the tuner and control center for the system in your pocket. Tiny phones in your ears, with individual receiving chips, will give you private AM-FM-stereo listening. They will be fed by wireless signals from the preamp-transmitter in your cigarette-pack-sized control unit. At your office, the control center can feed your private system of speakers there. A plug-in short-wave module, about the size of a pencil eraser, will be available for the SWLer. Similar accessories for CB, ham, personal communications, etc., will be available.

The foregoing ideas are merely examples of what's possible. The only real limitations on the size and versatility of electronic devices lie in the minds and imaginations of us in the field of electronics. The limitations we endure now are only obstacles to be overcome.

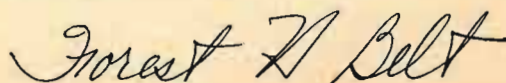

Radio-Electronics

March 1967 VOL. XXXVIII No. 3
Over 55 Years of Electronic Publishing

EDITORIAL

- 2** Can Electronics Get Much Smaller? Forest H. Belt

MICROELECTRONICS AND SOLID STATE

- 32** Designing With Integrated Circuits
How to build an amplifier with "packages of gain"
- 35** Tools and Tests for Transistor TV Jack Darr
Troubleshoot this new generation of compacts
- 40** High-Impedance Transistor Mixer W. Ford Lehman
How to mix two mikes into a single input
- 41** Transistor Circuits From Scratch Otis E. Van Houten
Painless design and construction of solid-state amplifiers
- 44** Getting to Know Low-Cost IC's Robert F. Scott
You can experiment with integrated circuits
- 47** Crusade Against Car Thieves John H. Fasal
A construction project to protect your auto from theft
- 55** Plastic Transistors — The Future Billions Keith W. Bose
Epoxy encapsulation of semiconductors improves reliability, lowers cost
- 57** An Experimenter's Transistor Test Set Donald R. Hicke
Makes semiconductor checking and experimenting easy
- 60** Walkie-Talkie Power Booster Arthur T. Crane KHA 9543
Increase rf output of that midget transmitter
- 70** Quick-Checker for Controlled Rectifiers Don Anglin
Easy to build, this handy instrument lets you evaluate SCR's and similar devices
- 85** IC Glossary Robert F. Scott

GENERAL ELECTRONICS

- 22** In the Shop . . . With Jack Jack Darr
Service Clinic
- 38** A Portable Color Recorder Joe Roizen
Now—home video tapes in color!
- 43** Electronics Culture Corner Phyllis Barlow
- 49** Twin 200-Watt-Second Solid-State Strobe Slaves E. F. Rice
A build-it-yourself accessory for photographers
- 52** Nomorule: A Complete Calculator on a Sheet of Paper John H. Fasal
Try this portable "computer"
- 67** Equipment Report: Lectrotech U-75 UHF Translator
JFD Auto TV Antenna
Mercury 1800 Vom
- 81** A Simple Winding Aid for Toroids Donald Null
- 83** Measure Power of Electronic Flash Nat Norman
- 90** R-E Puzzler Edmund A. Braun

THE DEPARTMENTS

- | | |
|--|---------------------------------|
| 16 Correspondence | 94 Noteworthy Circuits |
| 91 New Books | 82 Technotes |
| 80 New Literature | 93 Try This One |
| 75 New Products | 56 What's Your EQ? |
| 92 New Semiconductors,
Microcircuits & Tubes | 56 50 Years Ago |
| 4 News Briefs | 72 Reader's Service Page |



p 35—TINY TV TROUBLE



p 47—STOP CAR THEFTS

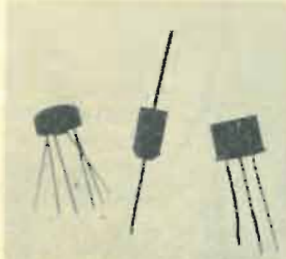

p 55—EPOXY-CASE XSTRS



p 57—TEST SEMICONS

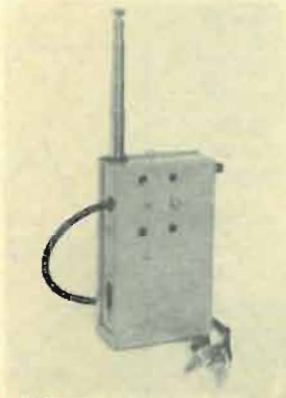

p 60—CB POWER AMP



p 49—PHOTO LIGHTING

RADIO - ELECTRONICS, MARCH 1967, Volume XXXVIII, No. 3. Published monthly by Gernsback Publications, Inc., at Ferry St., Concord, N. H. 03302. Editorial, Advertising, and Executive offices: 154 West 14th Street, New York 10011. Circulation Office, Boulder, Colo. 80302.

Second-class postage paid at Concord, N. H. Printed in U.S.A. One-year subscription rate: U. S. and possessions, Canada, \$5. Pan-American countries, \$6. Other countries, \$6.50. Single copies: 60c. © 1967, by Gernsback Publications, Inc. All rights reserved. POSTMASTERS: Notices of undelivered copies (Form 3579) to Boulder, Colo. 80302.

COVER FEATURE



p 38—The color boom has reached the low-cost video tape field. Here's the low-down on the first nonbroadcast color recorder for home, educational and industrial use. It employs a novel technique of preserving chroma information.

DESIGN IC STAGES

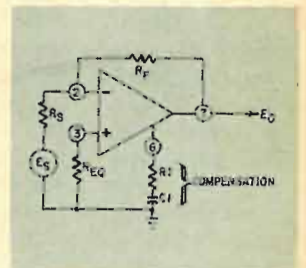

p 32—The newest and most flexible electronics building blocks are tiny solid-state chips called integrated circuits. These plug-in signal processors make it easier to assemble the kind of amplifier or receiver you want.



Member,
Institute of High Fidelity.
Radio-Electronics is indexed in
Applied Science & Technology
Index (formerly Industrial
Arts Index)

NEWS BRIEFS

MICROWAVE MICROTRANSMITTER

Electronics is getting to sound like science fiction—remember “*The Incredible Shrinking Man*”? Latest near-disappearance: an FM transmitter (range 60 MHz–2.5 GHz) slightly larger than a pinhead.

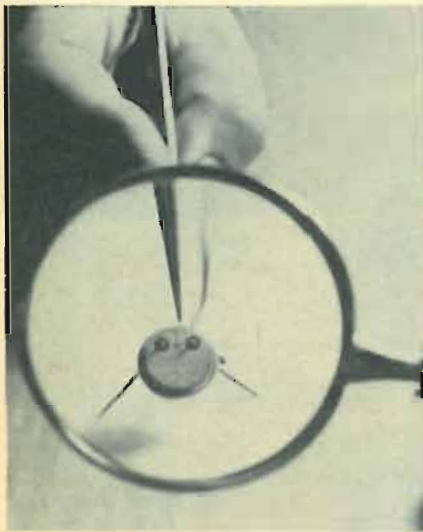

The device—shown in the photo dwarfed by its mounting holder—is made of gallium arsenide. The application of relatively high voltage to the semiconductor, causes *Gunn effect* and microwave emission. Field-effect principle is then used to modulate the microwave carrier. The new device has three terminals, is effectively a junction diode with a modulation gate added.

The tiny transmitter was developed by a team of RCA scientists, who envision hand-held microwave transmitters that would open up a new range of personal-communication possibilities.

SAY AGAIN?

Hearing aids—usually associated with advanced age—may be needed by youngsters before long. According to Robert A. Larabell, who runs an acoustics firm in Phoenix, Ariz., most rock 'n' roll music played in discotheques is simply too loud. The kids don't realize it, but they're doing serious damage to their eardrums.

Continual exposure to high sound

levels causes permanent damage to hearing. While most people can tolerate loud sounds if they're brief, few would care for high-level audio for hours at a time. Unfortunately, once your ears adjust to a high sound-pressure level, damage has already begun.

Inside a quiet house late at night, a sound-pressure level (SPL) meter registers about 40 dB. In a business office, the range is from 60 to 70 dB. Factories register from 75 to 85 dB. Larabell has measured 90-95 dB at 20 feet in front of a teenage rock 'n' roll band. This is roughly equivalent to the sound heard from a riveter 35 feet away. Although the threshold of pain begins at an SPL of 120 dB, ear damage can result from continuous exposure to much lower levels.

Perhaps the next teenage fashion should be a pair of Air Force jet earmuffs.

ENGINEERS STILL EARN MOST

Students who are graduated from engineering colleges this year will be paid an average starting salary of \$166 per week. That's the highest beginning wage ever paid to a new diploma holder, and tops all other graduates in business and industry. These estimates are compiled annually in a study of industry hiring practices by Frank S. Endicott, director of placement at Northwestern University. Since 1947

—when Endicott's surveys started—engineering graduates have consistently received top starting salaries.

BROADBAND LIGHT MODULATORS

The modulation of a laser beam, for transmitting information, has required much power and hasn't been possible with much bandwidth in the past. Now, Bell Telephone Laboratories scientists have discovered three ways to impress broadband signals on laser beams, using modulating powers of less than 1 watt.

The gallium-phosphide diode is one system (see sketch). Reverse bias is applied to the diode, and an incoming light wave is polarized and focused on the diode's pn junction region. The two polarization components of the light wave then travel at different velocities along the plane of the pn junction. They emerge from the junction out of phase with each other. This is equivalent to phase modulation. Finally, the phase-modulated components are passed through an output polarizer, where PM is converted to AM.

The gallium-phosphide diode can modulate light because of the linear electro-optic effect—which takes place in the diode pn junction when a reverse bias is applied. The semiconductor requires only 1.5 mW of power per MHz of modulation bandwidth.

The second device is a lithium

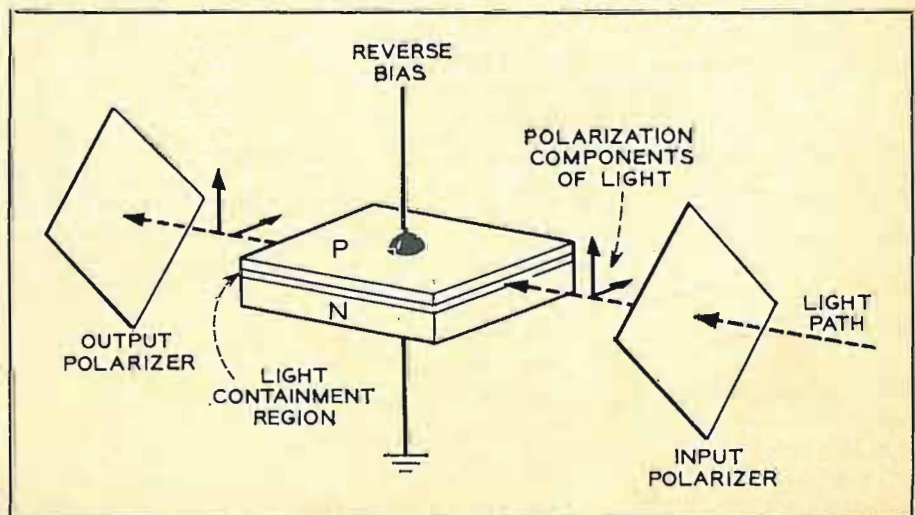

LOOK!

A New Electronics Slide Rule with Instruction Course

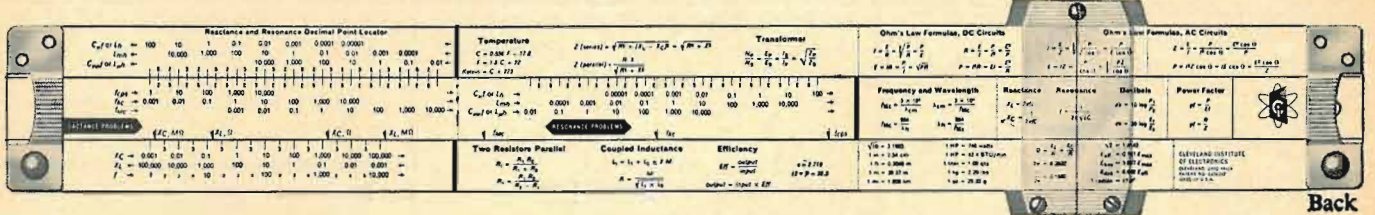
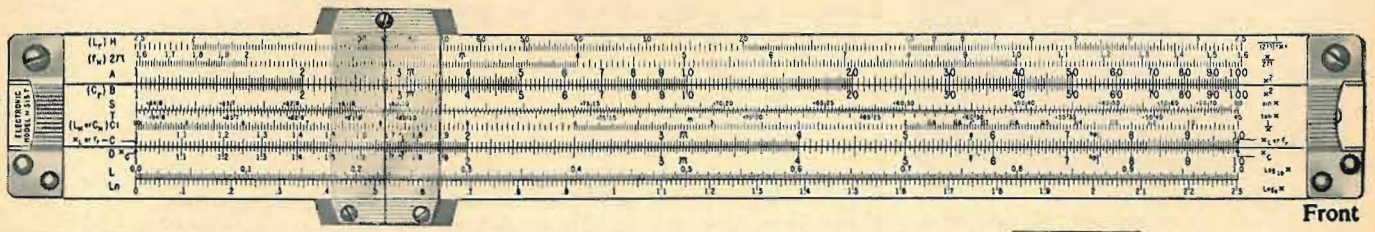

This amazing new "computer in a case" will save you time the very first day. CIE's patented, all-metal 10" electronics slide rule was designed *specifically* for electronic engineers, technicians, students, radio-TV servicemen and hobbyists. It features special scales for solving reactance, resonance, inductance and AC-DC circuitry problems . . . an exclusive "fast-finder" decimal point locator . . . widely-used formulas and conversion factors for instant reference. And there's all the standard scales you need to do multiplication, division, square roots, logs, etc.

Best of all, the CIE Slide Rule comes complete with an Instruction Course of four **AUTO-PROGRAMMED*** lessons. It includes hundreds of illustrations, diagrams and practice problems. You'll learn ingenious short cuts . . . whip through exacting electronics problems quickly and accurately. This course alone is worth far more than the price of the entire package!

Electronics Slide Rule, Instruction Course, *and* handsome, top-grain leather carrying case . . . a \$50 value for less than \$25. Send coupon for **FREE** illustrated booklet and **FREE** heavy vinyl Pocket Electronics Data Guide. Cleveland Institute of Electronics, 1776 E. 17th St., Dept. RE-137, Cleveland, Ohio 44114.

*TRADEMARK



GET BOTH FREE!

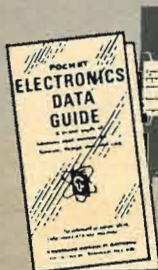

ELECTRONICS
SLIDE RULE

Send coupon today →

Cleveland Institute of Electronics

1776 E. 17th St., Dept. RE-137, Cleveland, Ohio 44114

Please send **FREE** Illustrated Booklet describing your Electronics Slide Rule and Instruction Course.

SPECIAL BONUS! Mail coupon promptly . . . get **FREE** Pocket Electronics Data Guide too!

Name _____ (PLEASE PRINT)

Address _____ County _____

City _____ State _____ Zip _____

A leader in Electronics Training . . . since 1934.

Circle 9 on reader's service card

One of a series of brief discussions
by Electro-Voice engineers



DEATH OF THE TINHORN

JACK BURCHFIELD
Chief Engineer
Loudspeakers

Over the past few years, public address loudspeakers have been introduced using new materials to replace the traditional aluminum and steel horns common on such equipment.

The first departure from tradition began with the Electro-Voice 848 (or "CDP®" for Compound Diffraction Projector). It was the first PA speaker to utilize Fiberglas-reinforced polyester resin construction. The initial use of this material, resulted from the solution to a unique and challenging loud-speaker problem.

The U.S. Navy faced a difficult sound distribution problem on the decks of Forrestal-class aircraft carriers due to the adoption of extremely noisy jet aircraft. To meet this specialized need, high-powered, wide angle speakers with great strength and low silhouette were required for installation at the edges of the flight deck. Fiberglas diffraction horns proved to be ideal. It was not long before commercial units, similar in concept to the Navy models, were introduced as the Models 848 and 847.

The Fiberglas horns have several advantages of interest to commercial sound installers, in addition to high impact strength. They do not rust, dent, corrode, or peel. Color is molded in, and regular painting is not needed. The shape of the horn can be molded to suit various sound distribution needs. This E-V innovation made rectangular wide angle designs practical.

Recently E-V continued its pioneering in plastics with the introduction of two new paging speakers. The smaller of the two, the PA7, is molded of Cyclocac, while the PA30 utilizes Implex R material for its construction.

These unusually rugged horns offer distinct appearance advantages to the sound contractor. No maintenance is required, since neither of these materials is affected by high humidity, reasonable levels of heat or cold, or corrosive atmospheres. The color is molded completely through the horn, and a smooth attractive finish is automatically produced.

Of course, modern plastics contribute to more than just appearance. The resonance characteristics of Cyclocac and Implex R can be controlled for results superior to typical metal paging horns. High uniformity of product, plus unique horn shapes dictated by acoustical requirements can be achieved by careful tooling.

While Electro-Voice continues to produce products using traditional materials, these plastic horns represent the benefits of E-V research into modern materials and methods. Application of new ideas to solve your sound problems is the goal of Electro-Voice engineering.

For technical data on any E-V product, write:
ELECTRO-VOICE, INC., Dept. 373E
613 Cecil St., Buchanan, Michigan 49107



NEWS BRIEFS continued

tantalate electro-optic modulator. It uses a coded sequence of high-speed electrical pulses or digits to modulate an equally fast, uncoded train of light pulses from a helium-neon laser. The lithium tantalate modulator is most useful in pulse-code modulation of digital information; it can handle up to 896 million bits per second.

The third device is an infrared modulator, consisting of a thin rod of gallium-doped yttrium iron garnet. Infrared light waves traveling through the crystal are continuously modulated when the direction of the crystal's internal magnetic field is varied. With power of only 0.1 watt, this device has a bandwidth of 200 MHz.

LASER BRAKE FOR CARS

A new combination of radar and laser techniques could decrease traffic accidents. A solid-state injection laser (see photo), in this case a semiconductor that emits coherent light, is being considered as the heart of a new form of automobile collision-avoidance system. Infrared light from the laser would be bounced off the car ahead—as in a radar system—and would warn if a collision was impending. Warning would be given with lights or audible signals; if the driver failed to take corrective action, brakes would be applied automatically.

The laser device also has possibilities as fog penetrator, burglar alarm, and private communications system. As the solid-state laser can be modulated, it could be used to aim a narrow beam of infrared "signals" at a receiver. Intercepting the message

continued on page 12



Radio-Electronics

154 WEST 14TH STREET
NEW YORK 10011

HUGO GERNSBACK, *editor-in-chief*

M. HARVEY GERNSBACK, *publisher*

FOREST H. BELT, *editor*

Bruce Ward, *production manager*

Robert F. Scott, W2PWC, *technical editor*

Thomas R. Haskett, *associate editor*

Jack Darr, *service editor*

I. Queen, *editorial associate*

Allen B. Smith, *science editor*

Peter E. Sutheim, *audio editor*

Wm. Lyon McLaughlin,

technical illustration director

Nancy Gitchel, *editorial assistant*

Adelaide Cassity, *production assistant*

G. Aliquo, *circulation manager*

Joseph L. Bund, *newsstand director*

Cover by Harry Schlack

RADIO-ELECTRONICS is published by
Gernsback Publications, Inc.

Chairman of the Board: Hugo Gernsback

President: M. Harvey Gernsback

Vice President-Secretary: G. Aliquo

ADVERTISING REPRESENTATIVES

EAST

John J. Lamson,

RADIO-ELECTRONICS, 154 West 14th Street,
New York 10011, 212-255-7755

MIDWEST/N.&S. Car., Ga., Tenn.

Robert Patis, the Bill Patis Co., 4761 West
Touhy Ave., Lincolnwood, Ill. 60646,
312-679-1100

W. COAST/Texas/Arkansas/Oklahoma

J. E. Publishers Representative Co., 8380
Melrose Ave., Los Angeles, Calif. 90069,
213-653-5841; 420 Market St., San Francisco,
Calif. 94111, 415-981-4527

UNITED KINGDOM

Publishing & Distributing Co., Ltd., Mitre
House, 177 Regent St., London W.1, England

SUBSCRIPTION SERVICE: Send all subscription correspondence and orders to RADIO-ELECTRONICS, Subscription Department, Boulder, Colo. 80302. For change of address, allow six weeks, furnishing both the old and new addresses and if possible enclosing label from a recent issue.

MOVING? Or writing about subscription? Be sure to fill out form below.

For FASTEST service on address change, missing copies, etc., attach old mailing label in first space below. Otherwise please print clearly your address as we now have it.

OLD ADDRESS (Attach old label if available)

Name

Address

City State

Zip Code

NEW ADDRESS

Name

Address

City State

Zip Code

Mail to: RADIO-ELECTRONICS
Subscription Dept. Boulder, Colo. 80302

DEVRY TECH NOT ONLY TRAINS
YOU... BUT HELPS YOU GET
STARTED AT NO EXTRA COST IN
THE **BIG-MONEY FIELD** OF

ELECTRONICS!

✓ PREPARE AT HOME

Whether you want to prepare for a good-paying new job or for advancement in Electronics with your present employer, DeVry Tech offers specialized educational programs designed to meet your needs. You set up your own HOME LABORATORY and work over 300 construction and test procedures to develop on-the-job type skills. You build a quality Transistorized Meter, a 5-inch Oscilloscope and a special Design Console. DeVry also includes modern "programmed" texts, instructive motion pictures, Consultation Service. Effective? Yes!



HOME LABORATORY EQUIPMENT
— YOURS TO KEEP!

✓ RESIDENT SCHOOL

If you prefer you may get all of your training in DeVry's U.S. or Canadian resident schools under the close guidance of friendly, experienced instructors. You work with a wide variety of commercial equipment similar to that actually used in industry as you prepare in our laboratories for a technician's job in Communications, Microwaves, Radio-Television, Automation, Radar, Computers, or other branch of Electronics. DeVry even provides part-time job placement service to those who wish to earn extra money while attending day or evening classes.



EXPERIENCED
INSTRUCTORS

✓ PLACEMENT SERVICE

Meet W. E. Bartz, who has helped thousands of DeVry men toward exciting, profitable careers in Electronics. When YOU complete your program, he will help you too. As Placement Manager in touch with business and industry across the nation, Bartz knows the employer demand for DeVry-trained men. He has cooperated in placing our graduates with thousands of firms!

Men 18-45, start preparing NOW for this vast opportunity field. Soon you should be ready for DeVry's valuable employment help!



MAIL COUPON TODAY!

No Advanced
Education or
Previous Technical
Experience Needed
to Get Started

Your ambition and desire to succeed are more important! DeVry guides you every step of the way toward success.

Free

Send coupon
for these two
factual book-
lets NOW!



DeVRY TECHNICAL INSTITUTE
4141 Belmont Avenue, Chicago, Ill., 60641 Dept. RE-3-X

Please give me your two free booklets, "Pocket Guide to Real Earnings," and "Electronics in Space Travel"; also include details on how to prepare for a career in Electronics. I am interested in the following opportunity fields (check one or more):

- | | |
|--|---|
| <input type="checkbox"/> Space & Missile Electronics | <input type="checkbox"/> Communications |
| <input type="checkbox"/> Television and Radio | <input type="checkbox"/> Computers |
| <input type="checkbox"/> Microwaves | <input type="checkbox"/> Broadcasting |
| <input type="checkbox"/> Radar | <input type="checkbox"/> Industrial Electronics |
| <input type="checkbox"/> Automation Electronics | <input type="checkbox"/> Electronic Control |

Name _____ Age _____

Address _____ Apt. _____

City _____ State _____ Zip _____ Code _____

Check here if you are under 16 years of age.

2103 HOME STUDY AND RESIDENT SCHOOL TRAINING
AVAILABLE IN CANADA

DEVRY TECHNICAL INSTITUTE

4141 Belmont Avenue • Chicago, Illinois 60641

Accredited Member of National Home Study Council

Circle 11 on reader's service card

**Discover the ease
and excitement of NRI's**

3 DIMENSIONAL

METHOD

of ELECTRONICS

TV-RADIO TRAINING

10 HOME-STUDY PLANS TO CHOOSE FROM

Ask men whose judgment you respect about NRI's three dimensional method of home-study training. Ask about the new, remarkable NRI Achievement Kit. Ask about NRI custom-designed training equipment, programmed for the training of your choice to make Electronics come alive in an exciting, absorbing, practical way. Ask about NRI "bite-size" texts, as direct and easy to read as 50 years of teaching experience can make them. Achievement Kit . . . training equipment . . . bite-size texts . . . the three dimensions of home-study training; the essentials you must have to make

learning easier, more interesting, more meaningful. You get them all from NRI.

Whatever your interest . . . whatever your need . . . whatever your education . . . pick the field of your choice from NRI's 10 instruction plans and mail the postage free card today for your free NRI catalog. Discover just how easy and exciting the NRI 3-DIMENSIONAL METHOD of training at home can be. Do it today. NATIONAL RADIO INSTITUTE, Electronics Division, Washington, D.C. 20016.

**BEGIN NOW AN ABSORBING
ADVENTURE—LEARN ELECTRONICS
THE EASY NRI WAY—MAIL CARD TODAY**

OVER 50 YEARS OF LEADERSHIP



IN ELECTRONICS TRAINING

1 Start Fast with NRI's New Remarkable Achievement Kit

The day you enroll with NRI this new starter kit is on its way to you. Everything you need to make a significant start in the Electronics field of your choice is delivered to your door. It's an outstanding way of introducing you to NRI training methods . . . an unparalleled "first dimension" that opens the way to new discoveries, new knowledge, new opportunity. The Achievement Kit is worth many times the small payment required to start your training. No other school has anything like it. Find out more about the NRI Achievement Kit. Mail the postage-free card today.



2 NRI "Bite-Size" Lesson Texts Program Your Training

Certainly, lesson texts are a necessary part of any training program . . . but only a part. NRI's "bite-size" texts are simple, direct, well illustrated, and carefully programmed to relate things you read about to training equipment you build. Here is the "second dimension" in NRI's training method. Here are the fundamental laws of electronics, the theory, the training of your choice, presented in a manner you'll appreciate. And in addition to lesson texts, NRI courses include valuable Reference Texts related to the subjects you study, the field of most interest to you.



3 Custom-Designed Training Kits Make Learning Come Alive

Electronics becomes a clear and understandable force under *your* control as you build, experiment, explore, discover. Here is the "third dimension" . . . the practical demonstration of things you read about in NRI texts. NRI pioneered and perfected the use of training kits to aid in learning at home. NRI invites comparison with equipment offered by any other school, at any price. Prove to yourself what 750,000 NRI students could tell you . . . that you get more for your money from NRI than from any other home-study Radio-TV, Electronics school. Mail postage free card for your NRI catalog. (No salesman will call.)

AVAILABLE UNDER NEW GI BILL — If you served since January 31, 1955, or are in service, check GI line in postage-free card.

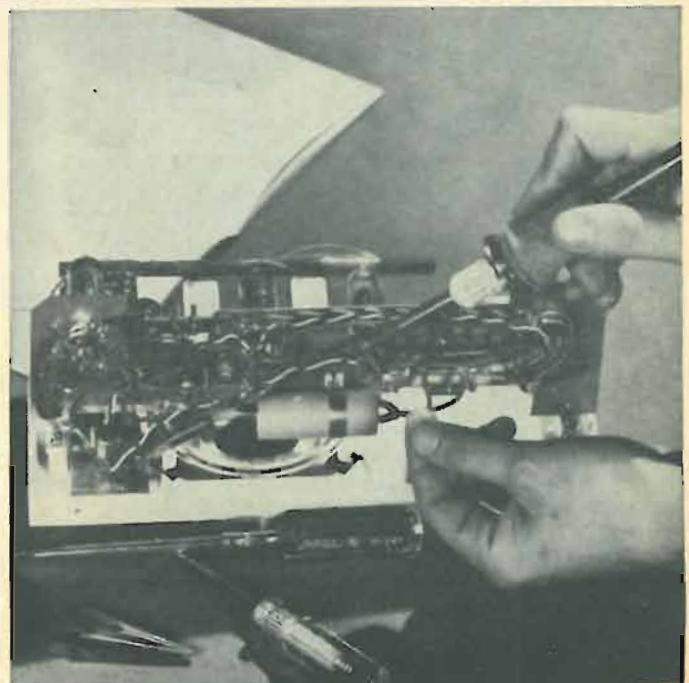

ACHIEVEMENT '67 IN ELECTRICAL/ ELECTRONICS ENGINEERING

**EXHIBITS
NEW YORK
COLISEUM**

**TECHNICAL
SESSIONS
NEW YORK HILTON**

Monday through Thursday
MARCH 20-23 1967

- 69 Technical Sessions at the New York Hilton. Hours: Mon. 9:30-12:00 a.m.; 2:00-4:30 p.m. — other days 9:00-11:30 a.m.; 2:00-4:30 p.m.
- **FOUR COMPLETE FLOORS OF EXHIBITS** at the New York Coliseum including over 700 firms. Hours: 10 a.m.-8 p.m. 4 Days.
- Gala Annual Banquet — Wednesday 7:15 p.m. New York Hilton Grand Ballroom — \$15.00
- Free shuttle busses between the Hilton and the Coliseum — every few minutes.
- Registration — IEEE Members \$2.00 Non-members \$5.00 Ladies \$1.00 High School Students \$2.00 if accompanied by an adult. One student per adult Monday through Wednesday, Thursday only — limit of 3 students per adult. Good for all days — Technical Sessions and exhibits. In and out privileges.



IEEE '67 International CONVENTION / EXHIBITION



At 300 rpm all you can hear is the music.

Most turntables utilize motors that operate at 1800 rpm. The new Sony Servo-Controlled TTS-3000 employs a motor that provides optimum torque at 300 rpm. The slower the motor, the less chance of rumble-producing vibration intruding upon your record-listening pleasure.

For precise speed-regulation, Sony employs the first precision servo-controlled motor ever used in a turntable. No rumble, no noise, precise speed, beautiful music from the Sony TTS-3000, \$149.50 (base extra).

For the finest playback system, add the Sony VC-8E moving coil cartridge, \$65 and the PUA-237 professional arm, \$85. Prices, suggested list. At your Sony high fidelity dealer. Sony Corporation of America, Dept. H, 47-47 Van Dam Street, Long Island City, N.Y. 11101

Circle 12 on reader's service card

NEWS BRIEFS continued

would be nearly impossible without knowing which way the transmitter was aimed.

Devices available from the developer (RCA) include a 50-watt injection-laser diode array about the size of a pencil eraser, a 2-watt unit smaller than a kernel of corn, and IR light emitter close to the size of the head of a pin.

SOLID-STATE RADAR

The transistor trend is making inroads in radar circles. In January 1966, Raytheon offered the first small-boat solid-state radar system. Now two other firms have brought out similar equipment.

Raytheon's model 1900A has a range of 18 miles, uses a 7-inch CRT, and consumes 220 watts. The unit offered by the British firm of Decca Radar, Inc. has 15-mile range, a 6-inch scope, and draws 165 watts. The Kaar Engineering Corp. system ranges up to 16 miles, uses a 10-inch scope display, with 156-watt power consumption.

None of these radar systems are completely solid-state, for the magnetron tube is still used in the transmitter. Substituting transistors for vacuum tubes in supporting circuitry, however, has reduced power consumption considerably. Standard small-boat radars using tubes draw around 500 watts. The use of semiconductors also results in a more rugged unit, better able to withstand the buffeting a ship receives in bad weather.

None of these radar systems is cheap. Prices range from \$2,400 to \$2,850.

TEENAGE STUDENTS DISCOVER SOVIET MISSILE BASE

As a man-made satellite moves across the sky, its radio transmissions change pitch slightly with respect to a fixed receiving station—due to Doppler effect. Using this principle, a group of English school students tracked Russian space launches. Working backward from the orbit records they accumulated, and using a computer, they pinpointed the location of a new missile base unknown to the West until now.

The students have a surplus WW II military radio, a 40-foot antenna, and an ordinary globe of the world. Since 1962, the group of 100 boys and girls—aged 15 to 18—have made 1,700 radio observations, recording the orbits of 75 USSR satellites. In some cases, they have recorded a missile launch before the Soviets have an-

Going to profit here?

Then profit here.

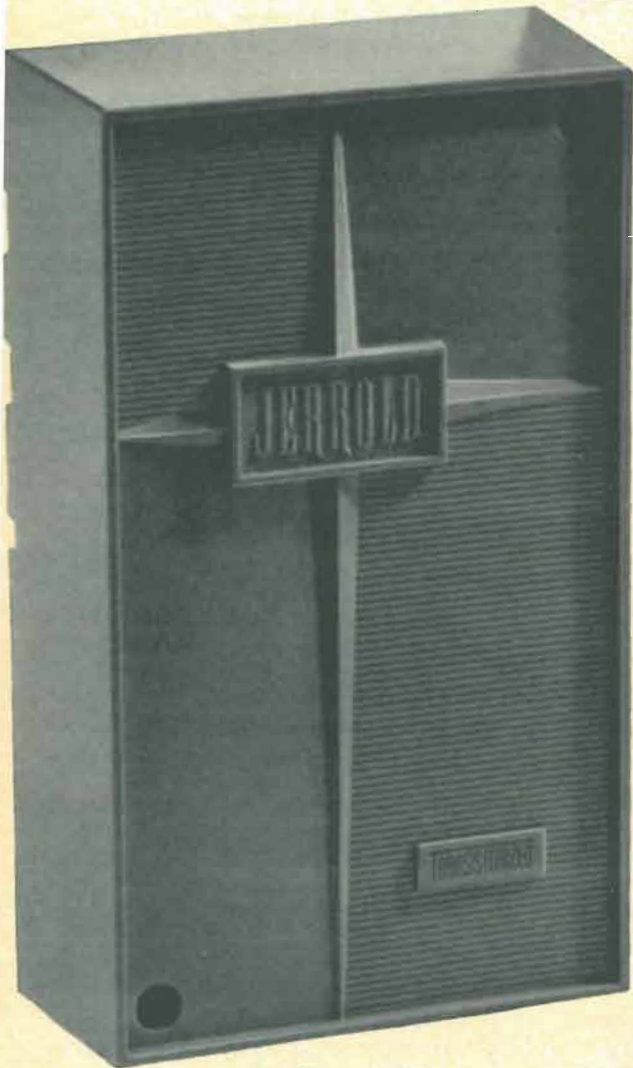

82 Channel TAC-4
List Price \$72.50

VHF Only Model TC-88
List Price \$39.95

New Jerrold 82 Channel Coloraxial Home System makes perfect sales mate with Color TV Antennas

Look around you. Every home—every new housing development—is a potential profit-making sales spot for you and the TAC-4 Home Master TV System. Here's why:

TAC-4 makes good color TV go a long way. Every color TV set needs a top-grade antenna for good reception. TAC-4 makes this good reception possible anywhere in the house by providing extension antenna outputs in various rooms for portable TV and FM sets as well as extra sets. *You can tie-in a TAC-4 with every antenna sale.* And don't forget, it's a handy sales feature that housing developers like to use to help sell a home.

TAC-4 handles all 82 TV channels (color and black and white) as well as FM. It's the industry's *first* amplified coupler that can handle all present and future channels. Just connect the antenna to the input

and then connect four or more sets to the outputs.

TAC-4 is easy to install. Coaxial inputs and outputs make connections simple. Coaxial cable can be run right along with other electric wires—without interference with the signal. And cail backs are practically unheard of because the amplifier is completely solid-state.

TAC-4 pleases customers. It's the first truly professional installation for assuring better TV and FM reception anywhere in the house. It's the superior amplifier-coupler to sell with any TV set or antenna such as the Jerrold Pathfinder series. Sell them together. Customers get top reception. You get top profits.

For more details, see your distributor.

JERROLD

DISTRIBUTOR SALES DIVISION
401 Walnut St., Phila., Pa. 19105

nounced it. All data gathered by the students is sent to the British space agency.

It has been known that the Russians have been using space-launch bases at Kapustin Yar and Tyuratam for several years. Site found by the British students is at Plesetsk, 400 miles north of Moscow and the USSR's first far-north space base.

BRIGHTER COLOR TV AHEAD

Rare-earth elements—used in at least one type of color CRT—now make possible a new glass filter plate which improves color brightness and contrast. *Opticolor* (trademark of the manufacturer, Chicago Dial Co.) is laminated to the faceplate of the CRT. The filter absorbs room light while permitting greater transmission of colored light from the screen outward.

Opticolor filters are made with neodymium oxide, a rare earth which contributes the unique ability to produce greater saturation of color hues. The class used is dichroic; its light transmission varies with different colors. (The same type of glass is used for the splitting mirrors in color TV cameras.)

CB REVOCATIONS

The Federal Communications Commission recently revoked the licenses of 12 Class D Citizens' Band radio stations. Several revocations involved more than one violation of FCC rules. In each case, however, the person holding the license had *failed to respond* to at least two official notices of violation and one show-cause order. (Failure to respond to a violation notice within 10 days is *itself* a violation of FCC rules.)

Reasons for the revocations were: five for off-frequency operation, and five for failure to properly identify the station. Three stations were also cited for hobby use, and two for communicating with another station for a period exceeding 5 minutes. Two stations failed to have their licenses posted at the control point.

Other violations: transmission not directed to a specific station; communicating or attempting to communicate over a distance of more than 150 miles; excessive power output; no transmitter identification card; communication concerning the technical capability of radio equipment; antenna over 20 feet in height; no current copy of Part 95 of FCC rules on hand; unauthorized transfer of station control.

END

Centralab's
full line
of color TV
components
include:

Fastatch® II
exact
replacement
controls

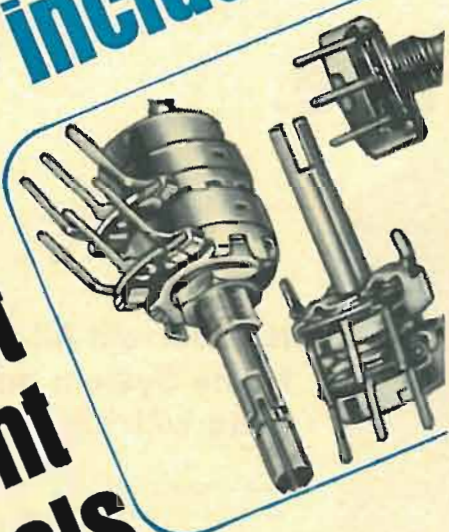
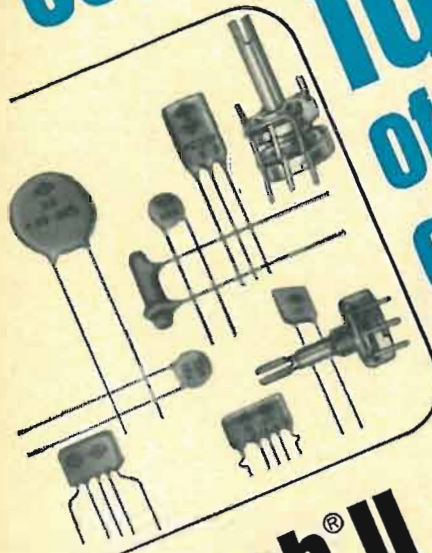

Almost any TV control can be replaced—*with an exact duplicate*—by your Centralab Distributor. That's because the Centralab Fastatch II system provides over 9 Billion control combinations, with exact length shafts, exact shaft ends, exact mounting hardware and exact electrical specifications. Not only dual concentrics, but singles and twins with or without line switches, and even buzz controls!

Color TV capacitors

Low voltage ceramics, standard ceramics, miniature electrolytics, polystyrenes . . . here too, you can get the Centralab exact replacement you need . . . from your Distributor.

Color TV packaged circuits

With over 200 types of exact replacement PEC® packaged circuits in stock and the industry's most complete replacement Guide, your Centralab Distributor can supply most of your TV replacements faster than any other source!

RELY ON YOUR CENTRALAB DISTRIBUTOR FOR THE FINEST COLOR TV REPLACEMENTS.

FREE

New detailed Catalog 33-GL of Centralab Color TV Replacement Components is available from your Distributor or by writing directly to Distributor Products, Centralab, The Electronics Division of Globe-Union Inc., P.O. Box 591, Milwaukee, Wisconsin 53201.



CENTRALAB

Electronics Division
GLDBE-UNION INC.

locate defective capacitors in-circuit

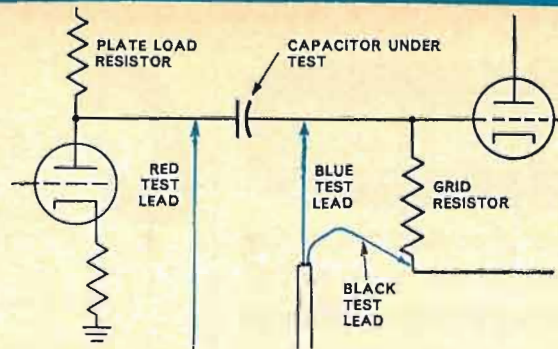

3-LEAD LEAKAGE TEST: One test lead is connected to the plate side of the capacitor and the ground lead to the grid leak return on the other side of the capacitor, and the meter is zeroed. The third test lead is then connected to the grid side of the capacitor and the meter scale shows the leakage directly in megohms.

The B & K model 801 capacitor analyst **really works** without unsoldering or altering circuitry



Both in-circuit and out-of-circuit capacitor testing can be done quickly and accurately with the new B & K Model 801 Capacitor Analyst. Foil, mica, general purpose and temperature compensating ceramic, and electrolytic capacitors can be accurately tested for leakage, capacitance, opens, and shorts.

Leakage can be determined in-circuit. The unique B & K 3-lead method permits a degree of accuracy not possible with any 2-lead tester. For normal circuits defective capacitors can be located immediately.

Open capacitors with values as low as 25 pF are easily located with the sensitive high-frequency-signal and resonant- $\frac{1}{4}$ -wave-transmission-line method.

Electrolytic capacitors are tested with a circuit that accurately measures their effective capacitance. Their inherent characteristics of variable equivalent series resistance and internal parallel resistance are automatically accounted for. Only one capacitor lead need be disconnected. The capacitor is charged and then discharged under load. High peak load currents up to 2 amperes ensure testing to in-circuit conditions. Unlike with other testers, capacitor can not be deformed by a reverse polarity voltage. The actual power transferred to a load is measured and the capacitance is read directly from the meter scale for immediate replacement decisions.

All these tests and short tests too are performed with the one set of test leads which is included with the instrument.

Here's the capacitor analyst that really works: B&K Model 801 quickly pays for itself with reduced shop time. Net \$109⁹⁵

See your B & K distributor or write for catalog AP-22.

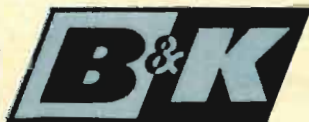

B & K MANUFACTURING CO.
DIVISION OF DYNASCAN CORPORATION
1801 W. BELLE PLAINE AVE. • CHICAGO, ILL. 60613
Canada: Atlas Radio Corp., 50 Wingold, Toronto 19, Ont.
Export: Empire Exporters, 123 Grand St., New York 13, U.S.A.

new Sams books

BRAND-NEW UP-TO-DATE 10TH EDITION
of the famous **HOWARD W. SAMS**
Tube Substitution Handbook

2-IN-1 PACKAGE!
Regular size for your bench—
Compact copy for your caddy



Here's what you get in this great low-cost package: 1. Latest 10th edition handbook (5½ x 8½" for bench use)—completely revised and expanded. The most complete, up-to-date direct tube substitution guide available. Now includes more than 11,300 substitutions for all types of receiving and picture tubes. Seven sections include:

- 1. Cross-reference of all American receiving types.
 - 2. Picture tube substitutions.
 - 3. Cross-reference of miniature tubes.
 - 4. Industrial substitutions for receiving tubes.
 - 5. Substitutions for communications and special-purpose tubes.
 - 6, 7. Cross-reference of American and foreign tubes.
 - 2. Caddy-size tube substitution handbook—contains the complete, identical data included in the larger edition—an ideal handy reference for outside calls. Each handbook tells you when and how to make proper substitutions. Both handbooks come in one vinyl-wrapped package. Order **TUB-10P Twin-Pak**, both books for only... **\$225**
- Shop edition only (5½ x 8½", 128 pages)—worth its weight in gold on your bench!
Order **TUB-10**, only... **\$1.75**

101 More Ways to Use Your Scope in TV. 2nd Ed.

by *Robert G. Middleton*. Newly revised handbook describes additional and somewhat more advanced uses of the scope not covered in the first volume. Includes use of lab-type triggered-sweep scopes as well as standard service type. Uses range from basic troubleshooting procedures to the more complex testing of circuit components. Explanations are easy to follow; each test describes equipment required, proper connections, test procedure and evaluation. Includes many actual photos of both circuit and specialized testing waveforms. 168 pages; 5½ x 8½". Order **TEM-7A** only... **\$295**

Silicon Controlled Rectifiers

by *Allan Lytel*. A complete and clear explanation of the fast-growing SCR solid-state field. Explains principles of SCR operation and shows their use in a variety of practical control circuits. Clearly describes phase shift control of a-c and d-c power; discusses circuits such as ring counters, temperature controls, and voltage regulation. Includes informative chapter on SCR testing. An invaluable book for everyone who wants to be up on this important new solid-state development. 128 pages; 5½ x 8½". Order **SCL-1**, only... **\$275**

How to Repair Small Appliances. Vol. 2

by *Jack Darr*. Makes it simple to repair seemingly complicated household appliances. Explains how to repair the following electrical appliances not covered in Vol. 1: Portable heaters, hair dryers, carving knives, tooth brushes, bottle warmers, sewing machines, and nine other electrical appliances. A remarkably useful guide for profit-making or money-saving repairs. Fully illustrated. 128 pages; 5½ x 8½". Order **APD-1**, only... **\$275**

HOWARD W. SAMS & CO., INC.

Order from your Sams Distributor today, or mail to Howard W. Sams & Co., Inc., Dept. RE-3, 4300 W. 62nd Street, Indianapolis, Ind. 46268

- Send me the following books:
- TUB-10P TEM-7A APD-1
 - TUB-10 SCL-1

Send FREE Sams Booklist. \$_____ enclosed

Name _____
Address _____
City _____ State _____ Zip _____
My Distributor is _____

Circle 16 on reader's service card

Correspondence

COMPETITION

Dear Editor:

In your editorial "A Shortage of Service Technicians" in the October 1966 issue you mention that electronics schools find their television and radio courses aren't nearly so popular as their industrial electronics and advanced technology curricula. I find that understandable, because when you finish a radio and television servicing course and start your business you'll soon find out that you are competing with RCA and Sears. Both of these giant corporations compete with the independent serviceman who is trying to make a success of his business.

THOMAS GARBLER
Wilkes-Barre, Pa.

ALWAYS A BETTER WAY

Dear Editor:

There is an easier solution than the one given in "Lights-on Reminder For Your Car" (RADIO-ELECTRONICS, December 1966, page 53).

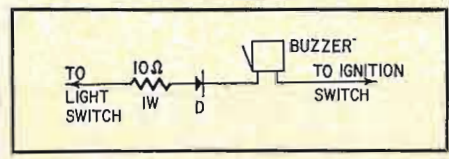

Both the diode and resistor can be mounted under the buzzer cover. The diode is reverse-biased with lights off and ignition on. With lights on and ignition off, one side of the buzzer is grounded through the low-resistance ignition system, the diode conducts and the buzzer sounds. When lights and ignition both are either on or off, no potential difference exists. Simply reverse leads for positive-ground cars.

I guess all this explaining is unnecessary to readers of this magazine.

ARNOLD NECKER
Medicine Hat, Alta., Canada

PROBLEMS IN SERVICING

Dear Editor:

Art Margolis' story "Selling the Chassis Overhaul" in the December

1966 issue is quite true and shows a problem of mine in this business. Being handicapped, I drive no service car or pickup truck. My business sign is a homemade one of jigsawed letters.

In my shopping center, a small neat radio-TV sales and service store with two pickup trucks has opened. Most of my service business has gone to them, even though their prices are higher than what I charged. The pickup truck and display has taken over my instruments and knowledge.

The return promise Art mentions, I handle differently. Customers that want their sets fixed in too short a time, I give no guarantee. If the set is left overnight, I can watch the repaired receiver with its cover removed and the picture reflected in a large mirror. When the customers come for their set the next day, I can safely return it with a written guarantee on the repaired circuits.

The serviceman is a superman to the children when he's in time to save their programs. This you expect from kids, but many mothers and dads will not sacrifice an evening of TV so the serviceman can check the receiver on his bench for better results.

As Art Linkletter says, "People are funny."

PETER LEGON

Malden, Mass.

SATISFIED CUSTOMER

Dear Editor:

I have completed building the transistor stereo amplifier with the Complementary OutPut circuit described by Richard J. De Sa in July 1966 RADIO-ELECTRONICS on page 48. The sound is surprisingly top quality. This amplifier was quite easy to build. The only problem was in getting some of the parts. Parcel post to Hawaii is a month away and two items were back-ordered. Well worth waiting for, though, and I want to thank Mr. De Sa and the editors of RADIO-ELECTRONICS.

J. F. HARRIS
END

Kailu, Kona, Hawaii

MOVIES BY TAPE RECORDER

With an ordinary TV receiver and a video tape recorder, you can make your own copies of movies right off the air. The simple adapter you need can be built from instructions in

April RADIO-ELECTRONICS

Some plain talk from Kodak about tape:

Kodak
TAPE MARK

Uniform magnetic sensitivity (or the lack thereof)

Uniformity for a tape is like kissing babies for a politician. Without it, you're hardly in the running. We take uniformity in all of tape's characteristics very seriously at Kodak. Maybe it's all those years of putting silver emulsions on film that's made us so dedicated to the idea. Uniformity in terms of magnetic sensitivity is one of the most important measures of a tape's performance. Non-uniformity can result in all sorts of bad things like level shifts, instantaneous dropouts, periodic non-uniformity, output variations, distortion, and variations from strip to strip.

Testing for all these possible flaws on a tape is a simple procedure in the lab. Standard industry practice is to record a long wavelength signal (37.5 mil) at a constant input level. The signal from the playback amplifier is then filtered and the output at particular critical wavelengths is permanently charted by a high-speed pen recorder which registers variations on a chart. Instantaneous dropouts caused by foreign matter on the tape surface, for example, would look like this:

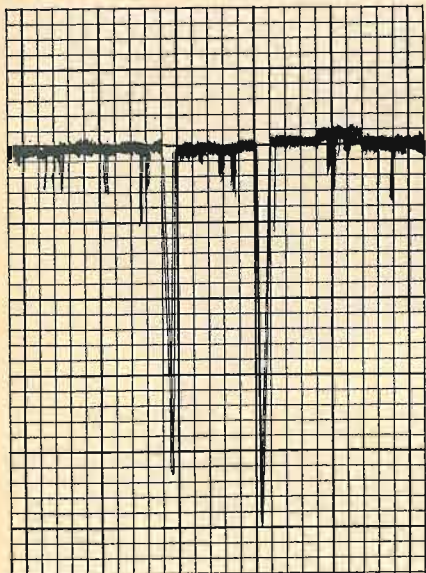

The long and the short of it

The low frequency procedure gives a good picture of variations in oxide thickness. We take it one step further . . . also test for short wavelength—1.0 mil. This helps evaluate surface smoothness and tape-to-head contact. Taken together, they aid in evaluating the level of lubrication, slitting, and oxide binder characteristics. The smoother the lines, the more uniform the magnetic sensitivity. Guess which graph below is KODAK Sound Recording Tape (the other two graphs represent quite reputable brands of other manufacture):

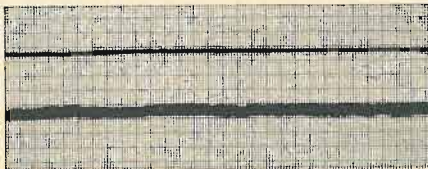

A.

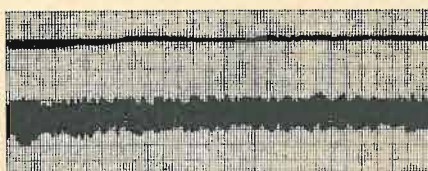

B.

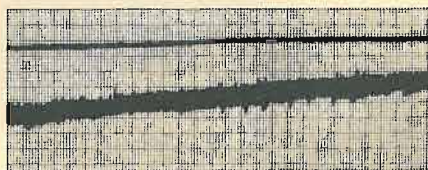

C.

What looks good sounds good
Congratulations if you picked brand A, Kodak tape. It is notably more uniform . . . doesn't vary more than $\frac{1}{4}$ db within the reel . . . no more than $\frac{1}{2}$ db from reel to reel.

You benefit as follows:

1. Within-reel uniformity.

(a) Less instantaneous and short term amplitude modulation of the signal, which results in a cleaner signal on playback.

(b) Reduced drift gives less variation in frequency response.

(c) Better uniformity across the strip width (no lengthwise coating lines) results in a more nearly balanced output for stereo recordings.

2. Reel-to-reel uniformity.

(a) Better coating uniformity gives a more uniform low-frequency sensitivity. This allows splicing of sections of tape from one reel with tape from other reels without obvious signal level changes.

(b) Better coating uniformity also results in a minimum change in optimum bias which allows the professional to establish an operating bias nearer the optimum bias.

KODAK Sound Recording Tapes are available at most camera, department, and electronic stores. New 24-page comprehensive "Plain Talk" booklet covers all the important aspects of tape performance, and is free on request. Write: Department 940, Eastman Kodak Company, Rochester, N.Y. 14650.



**“He’s a good worker.
I’d promote him right now
if he had more
education in
electronics.”**



Could they be talking about you?

You'll miss a lot of opportunities if you try to get along in the electronics industry without an advanced education. Many doors will be closed to you, and no amount of hard work will open them.

But you can build a rewarding career if you supplement your experience with specialized knowledge of one of the key areas of electronics. As a specialist, you will enjoy security, excellent pay, and the kind of future you want for yourself and your family.

Going back to school isn't easy for a man with a full-time job and family obligations. But CREI Home Study Programs make it possible for you to get the additional education you need without attending classes. You study at home, at your own pace, on your own schedule. You study with the assurance that what you learn can be applied to the job immediately.

CREI Programs cover all important areas of electronics including communications, servo-mechanisms, even spacecraft tracking and control. You're sure to find a program that fits your career objectives.

You're eligible for a CREI Program if you work in electronics and have a high school education. Our FREE book gives complete information. Airmail postpaid card for your copy. If card is detached, use coupon below or write: CREI, Dept. 1425E, 3224 Sixteenth Street, N.W., Washington, D.C. 20010.



The Capitol Radio Engineering Institute

Dept. 1425E, 3224 Sixteenth Street, N.W., Washington, D.C. 20010

Please send me FREE book describing CREI Programs. I am employed in electronics and have a high school education.

NAME _____ AGE _____

ADDRESS _____

CITY _____ STATE _____ ZIP CODE _____

EMPLOYED BY _____

TYPE OF PRESENT WORK _____ GI BILL

- I am interested in Electronic Engineering Technology
 Space Electronics Nuclear Engineering Technology
 Industrial Electronics for Automation
 Computer Systems Technology

APPROVED FOR VETERANS ADMINISTRATION TRAINING

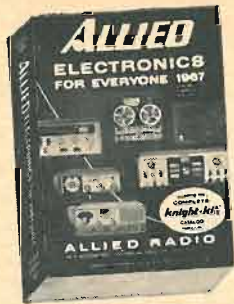

FREE

NEW 514-PAGE
1967
ALLIED
CATALOG

Top savings on the best
in electronics for everyone

SAVE MOST ON:

- Famous Knight-Kits
- Stereo Hi-Fi
- Tape Recorders & Tape
- CB 2-Way Radio
- Walkie-talkies
- FM-AM & AM Radios
- Short Wave & Ham Gear
- Portable TV & Phonos
- Intercom & P.A.
- Automotive Electronics
- Test Instruments
- TV Antennas & Tubes
- Power Tools, Hardware
- Tubes, Transistors
- Parts, Batteries, Books

Shop by mail and save at Allied, world's largest electronics headquarters. Hundreds of money-saving values, including fun-to-build Knight-Kits, and many specials available only from Allied. **NO MONEY DOWN! 24 MONTHS TO PAY!** Enjoy the things you want now, while you pay for them on the convenient Allied Credit Fund Plan.

Send for new 1967 ALLIED Catalog.

FREE!

ALLIED RADIO, DEPT. 2-C
P.O. BOX 4398, Chicago, Ill. 60680

Send FREE 1967 ALLIED CATALOG

Name _____
PLEASE PRINT

Address _____

City _____ State _____ Zip _____

Circle 18 on reader's service card

NOW...BUILD YOUR OWN CCTV CAMERA

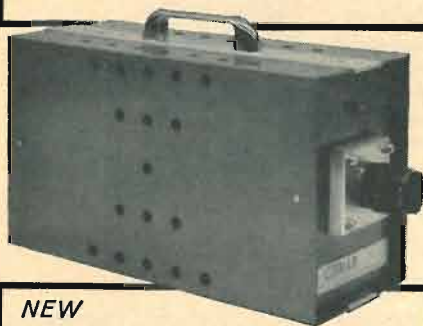

NEW
IMPROVED MODEL!

- Vidicon
- 25mm. f1.9 Lens
- Cable
- Instructions

\$209.50

\$20 DOWN
\$10 MONTH

ASSEMBLED \$259.50

The affordable answer to an easy-to-use, top performing surveillance camera. Hundreds of uses in home, store, plant, office, hospital, school. Connects instantly to any TV set. Gives excellent picture with light from 150-watt bulb. Operates up to six sets. Complete—nothing else to buy. Optional lenses and tripod available.

All parts guaranteed one year. Vidicon guaranteed 90 days. Make check or money order to CONAR. Shipped REA collect.

SEND FOR FREE CONAR CATALOG

CONAR Division of National Radio Institute, Dept. CC7C
3939 Wisconsin Avenue, Washington, D.C. 20016

SERVICE CLINIC

In the Shop... With Jack

By JACK DARR

TRANSISTORS HAVE BEEN WITH US FOR a long time. Yet too many of us still don't *know* them—know them in the sense that we know vacuum tubes—how to test and repair solid-state circuits. I just went to a service meeting held by one of the bigger TV manufacturers, and they were handing out booklets of transistor *fundamentals!* Worst of all, the men were reading the books as if they'd never seen semiconductors before!

Let's face it; transistors are here, and they're not going to go away if we ignore 'em. So, we might just as well heave a big sigh and get down to dealing with the things. Actually, semiconductors are a blessing in disguise. They're going to eliminate one of our worst financial troubles.

Fact No. 1: There's no such thing as a drug-store transistor tester! Only a *trained technician* can make repairs to transistorized equipment; here *we* are, ready and waiting!

Fact No. 2: Transistor amplifiers and receivers *are* hard to work on. The chassis are small, the parts crammed in so tightly it's hard to see 'em, let alone get one out. The actual repair isn't too difficult, but the gear is hard to test, *if* we use the same old test methods that have worked in bigger equipment.

What do we do? If we can't lick 'em, we join 'em. We get tools and test equipment that will let us troubleshoot solid-state gear with the same ease as vacuum tubes. Oh yes—with magnifying glasses, tiny tools and soldering irons we're in business.

The worst problem lies right between our ears, in our *thinking* about transistor equipment. Quite frankly,

we've been snowed with so much complicated stuff about holes, majority carriers, depletion layers, Y-parameters, and even, save the mark, h-parameters, that we're scared! A great deal of this is *design* information. It's necessary to the man building transistor gear, but not to the guy troubleshooting.

Transistors complicated? No! A vacuum tube is about as complex as you can get, yet we work with them every day and think nothing of it. We can work with transistors, if we use the right approach.

Stop worrying about complicated ideas—think of a transistor as a "package of gain." What does a tube do? Amplify a signal. You put a little bit of signal in at the grid and get a lot of signal out at the plate. A transistor does the same thing. You put a little signal in at the base and get a bigger signal out at the collector.

Transistor circuitry is practically all on PC boards. What we need is a test method that eliminates a lot of the hard-to-get-at tests and puts us at the "scene of the crime" faster. There's a way, one of the oldest—signal tracing. Follow the signal through the circuit, find out where it stops, and there's the trouble. Now we make detailed tests, but we've cut the problem down to one transistor and a few small parts!

The method isn't hard. All we need is a test signal and an output indicator. A signal generator and a scope are preferable, 'cause they're fast, but the signal source can be one of those pen-light-sized noise generators, and the indicator the speaker itself. For something like a tiny radio, try this: Feed an audio signal into the output stage base (input). If it comes through, go on back, one stage at a time, to the detector.

Now switch to a modulated i.f. signal, and work your way back through the i.f.'s, one at a time, until you get to the mixer/oscillator. There, switch to an rf signal, and go on to the antenna. If you've fixed all the troubles you found along the way, the set ought to work. There is only one difference between transistor- and tube-radio testing: always use a blocking capacitor in the signal-generator output lead. That keeps you from upsetting the tiny bias voltages on the transistors.

Hi-fi and stereo amplifiers are even simpler to check. All we need is an audio signal. We can check stage gain at

This column is for your service problems—TV, radio, audio or general and industrial electronics. We answer all questions individually by mail, free of charge, and the more interesting ones will be printed here.

If you're really stuck, write us. We'll do our best to help you. Don't forget to enclose a stamped, self-addressed envelope. Write: Service Editor, Radio-Electronics, 154 West 14th Street, New York 10011.

any point in the circuit by feeding the signal to the input and tracing it through the circuit with an output meter. Incidentally, use a blocking capacitor in the meter circuit, too; a rectifier-type ac voltmeter will often give false indications if dc is present in the circuit! You can read the signal voltage at the input and output of a transistor, check coupling capacitors for opens, and things like that.

The concept of transistor "current amplification" has thrown a lot of us. It shouldn't. A transistor *does* amplify current, yes; so does a tube. Think of it like this—you have a stage working into a *fixed* load. It's usually a resistor, but that makes no difference. If you change the current through the load, how can you keep from changing the *voltage* across it? You can't. So, we can use voltage measurements in testing transistor circuits just as easily as we have in tube circuits all these years. This is especially true of *signal* voltages. They might not be very big in transistor circuits, but they're there, and they do the same things they do in tube circuits!

Also, voltage tests are simpler. You must break the circuit to read current, but you can make voltage tests with the quick jab of a test prod. So, let's use the fastest method. Make voltage tests until we find the trouble, and then, if necessary, make current tests.

Here's one practical hint: I've watched real hot-shots working on transistor circuits, and they all check *emitter* voltage first. Many transistor stages use common-emitter hookups, with a small resistor in the emitter circuit. This resistor is common to both base and collector circuits. If the emitter voltage isn't there at all, or if it's 'way off, there is trouble.

Transistor testing, something that has bugged a lot of us, is getting easier. There are now testers that will check transistors in the circuit, with ease and accuracy. They're actually faster than tube-testers! Three connections, push the button and there you are.

Try this technique yourself; use the one thing that's common to all kinds of equipment—the signal. Doesn't matter what kind of signal—a simple sine wave, a TV signal, sync—anything. As long as you know what it is, you can trace it, and find out what's happening along the way. When you find the place where the signal stops, you're home. Up magnifying glasses and at 'em!

Pushoff adjustments on changer

My Webcor stereo record player will cycle, but the records won't drop. The record holes aren't worn, but the



The "living end"... for pro quality home recordings

Sonotone full fidelity microphones

Wondering why your home recorded tapes sound dead, lack professional quality? Stop guessing.

That accommodation mike given with your tape recorder just isn't in the same league with your recorder's pick-up capabilities.

For results you'll be proud of, plug a full fidelity Sonotone microphone into your tape recorder. The improvement will delight you!

Sonotone microphones capture all the richness and vibrancy of "living" sound... consequently, you take full advantage of your tape recorder's output capabilities.

For fine dynamic, as well as ceramic, microphones... ask for a Sonotone mike. At your hi-fi dealer. Or write to

ELECTRONIC APPLICATIONS DIVISION
SONOTONE
audio products
SONOTONE CORPORATION, ELMSFORD, N.Y. 10523

SONOTONE
AUDIOPHILE
SERIES

Electronic Applications Division, Export: Singer Prods. Co., Inc., N.Y.C., Cable: Exregnis; N.Y.

Swingin'
Combo
for
Top
Performance!



NEW SENCORE SM112B SERVICE MASTER VTVM/VOM

Here it is—the third generation of Sencore's famous Service Master—the two-in-one professional instrument that saves your time, speeds your service work, puts extra profits in your pocket.

- Just one function switch, one range switch and one probe provide all functions of VTVM and VOM.
- Voltage, current and resistance in 33 ranges — for accurate measurements anywhere, anytime.
- VTVM operates from 115v AC for precise bench or lab work; battery powered VOM gives you a 5000 ohms per volt meter.
- Lighted arrows automatically indicate VTVM scales.
- Large, easy-to-read 6-inch two percent meter covers all measurements.
- Handsome new styling in tough, vinyl-clad steel case.
- Optional high voltage probe attaches for measuring up to 30,000 volts DC.

So why use two when one will do—the new Sencore SM112B. Truly professional quality, and still only **\$89.95**

High Voltage Probe HP118 **\$7.95**



SENCORE

NO. 1 MANUFACTURER OF ELECTRONIC MAINTENANCE EQUIPMENT

426 SOUTH WESTGATE DRIVE, ADDISON, ILLINOIS 60101

Coming Next Month . . . in APRIL

Radio-Electronics

A real bargain package for the technician, engineer, builder, experimenter, expert, novice—everyone who takes his electronics seriously

TV FOR VIDEO RECORDING

A low-cost monitor for VTR playback and a source for off-the-air recordings. Easy to fabricate from almost any TV receiver with this simple adapter. Still works as normal TV, too.

ELECTRONICS TESTS

AIR WAR TACTICS

Testing our fighters and bombers during passes at tree-top level, a tricky operation at near-sonic speeds. An on-the-scene report.



LIGHTNING AND UFO'S

Our science editor investigates one of Nature's most puzzling phenomena. A thorough analysis of what we know about lightning, what we're learning, and how this research applies to that mystery: UFO's.

FAST REPAIR FOR COLOR TV

Caught without the test equipment he needs, resourceful author Larry Allen uses a very common piece of inexpensive test equipment to substitute for a video dot-bar generator. Read this one.



PLUS OUR ANNUAL SPRING ANTENNA SECTION

- Transistor Antenna Preamps
One article that really tells you what's what about these important devices. Explains noise figure, gain, bandwidth, tilt, and all the technical mumbo-jumbo used to describe them.
- Lightning Arrestor for CB Antennas
- High-Gain UHF Antenna To Build
- Master or CA Systems and the dB

Make sure you get this valuable issue. Order your subscription or tell your distributor or newsstand dealer to save you a copy! On sale March 23.

The APRIL 1967 Special

Issue of **Radio-Electronics**

discs won't fall when they should. Should I replace the spindle?—J. P., Springfield, Mass.

Not yet. Cycle the changer by hand with motor off, and watch the "pushoff finger" in the spindle. It should come up and out exactly flush with the side of the main spindle. If it won't come out far enough, the record won't be pushed off the holding notch.

Look underneath; you'll find a slab-headed screw and locknut on the bottom end of the spindle. Loosen the locknut and turn the screw in about half a turn. Recheck cycling by hand, and readjust if necessary to make the pushoff arm come out far enough. If it won't, then replace the spindle. Be sure to retighten the locknut firmly.

Ac meter-rectifier hookups

I have an old volt-amp-wattmeter made by Radio City Products, model 417. The meter rectifier and a couple of resistors have burned up. These were for the 0.25- and 1-amp scales. I replaced the rectifier, and have problems! Now the meter reads only half the line voltage, unless I take one wire from the rectifier off! Also, I can't get the two resistors right; if I get the voltage right on one scale, the other one is off. Help! —F. Z., Cicero, Ill.

Let's take your troubles one at a time. There are several ways of hooking up meter rectifiers. From your sketch of the whole circuit, it looks as if this one used a series-shunt connection, as in Fig. 1-a. Trace the circuit through the meter, and you'll see that one rectifier's in series, rectifying one half-cycle of the applied voltage, while the other rectifier is shunted across the meter.

Now the fun starts. Look at the rectifier polarities. If you disconnect the shunt rectifier (D2) what remains is D1, a simple half-wave rectifier, and the

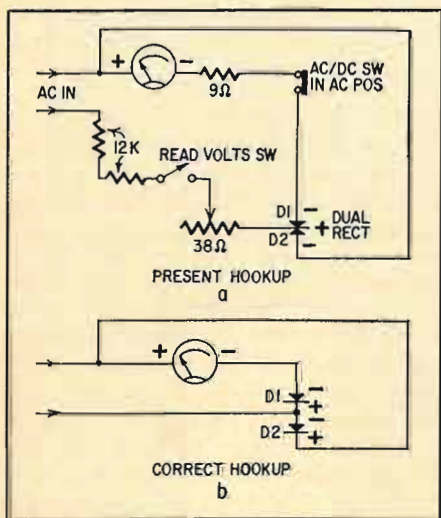

...and the public address system will use QUAM speakers!



MODEL 8C10PA

For top quality public address. This 8" speaker has a 10 oz. ceramic magnet, frequency response of 55-13000 Hz., easily handles 12 watts. One of 34 Quam speakers for sound system applications.

Men who specify loudspeakers in enormous volume have to be particular about quality and performance. That's why more and more sound system installers are developing the habit of specifying Quam.

It's a good habit to acquire, because Quam makes good speakers for public address, background music and other sound system needs, as well as for radio-tv-automotive replacements.

Whatever kind of speaker you need, look for Quam, the Quality line, in the red, white, and blue package at your distributor.

QUAM QUAM-NICHOLS COMPANY
234 E. Marquette Road—Chicago, Illinois 60637

Circle 21 on reader's service card



The 3rd Generation arrives!

INTEGRATED CIRCUITS NOW IN SCOTT RECEIVERS
Brings stations you've never heard before to life with amazing clarity!

First tubes, then transistors and FET's . . . and now, incorporating the most important technological advance of the decade, Scott's new 3rd generation receivers . . . each with 4 Integrated Circuits! Scott Integrated Circuits are designed into the 388 120-Watt AM/FM stereo receiver, the 348 120-Watt FM stereo receiver, and the 344B 85-Watt FM stereo receiver, and the 342 65-Watt FM stereo receiver. Now you can hear more stations with less noise . . . less interference from electric razors, auto ignitions, etc. Scott conservatively rates capture ratio of these new receivers at 1.8 dB . . . selectivity at 46 dB! And, you'll enjoy this amazing performance for many, many years, thanks to the rock-solid reliability of Scott IC's. Your Scott dealer will gladly demonstrate to you the astounding capabilities of these new receivers.



FREE . . . fact-filled, fully illustrated booklet on Scott Integrated Circuits . . . simply circle Reader Service Number 100.

Circle 100 on reader's service card

The most experienced all-channel amplifiers keep getting better and better

Blonder-Tongue pioneered and developed the industry's first all-channel, all-transistor TV signal amplifier. That was more than two years ago. During that period this top-rated original design has brought superior all-channel and color reception to homes located in all areas.

Now, we are employing the better performing silicon transistor in these amplifiers. The result: 40% more gain in the lowband, 100% more in the highband, greater ability to handle strong signals without overloading and better signal to noise ratio. Color or black-and-white TV reception on any and all channels from 2 to 83 is better than ever.

Only Blonder-Tongue gives you a choice of all-channel, color-approved amplifiers:

U/Vamp-2—mast-mounted, deluxe 2-transistor UHF/VHF amplifier. Weatherproof housing. Remote power supply. AC operated. Separate UHF and VHF 300-ohm inputs and outputs. Ideal for separate UHF and VHF antennas.

Coloramp-U/V—same as the U/Vamp-2 except it has a single UHF/VHF input. Matches the new all-channel antennas.

V/U-All-2—deluxe 2-transistor indoor UHF/VHF amplifier. Can drive up to 4 TV sets. Has built-in 2-way splitter with excellent impedance match and isolation for interference and ghost-free reception.

These UHF/VHF amplifiers are just one more reason to go all-channel from antenna to TV set with color-approved Blonder-Tongue TV products. Of course, we also have a full line of top quality VHF, VHF/FM and UHF-only amplifiers. Write for free catalog #74.

Blonder-Tongue Laboratories, Inc., 9 Alling Street, Newark, N. J. *Blonder-Tongue, the name to remember, for TV reception you'll never forget*

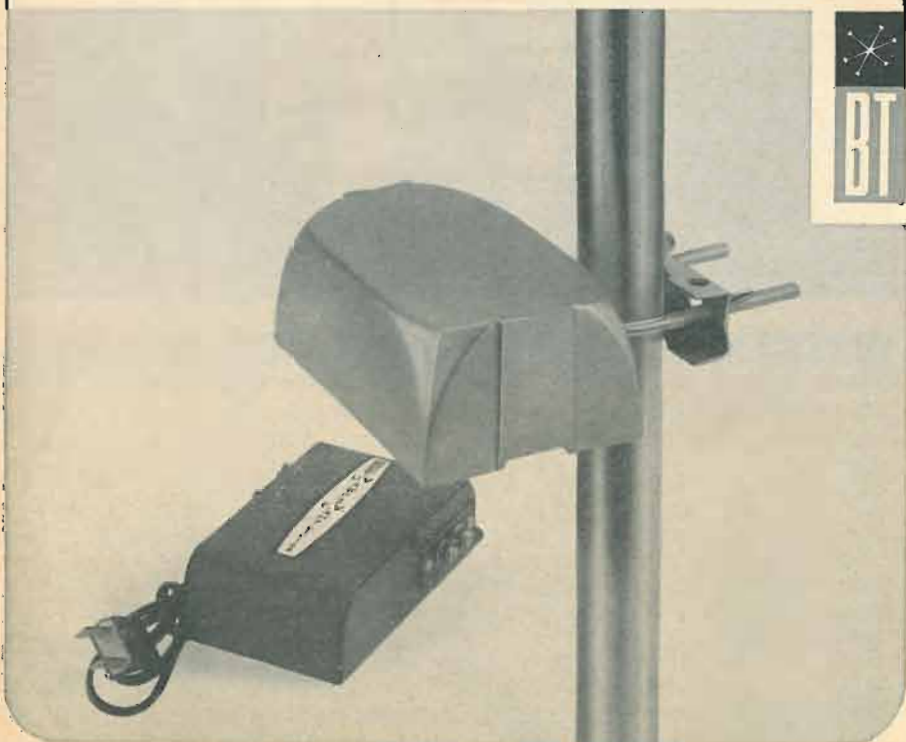

Circle 22 on reader's service card

SERVICE CLINIC continued

meter reads full line voltage. Connecting D2 produces a "bucking-out" effect! D2 is feeding a *negative* voltage back into the positive terminal of the meter! This E_{neg} cancels much of D1's output, and the meter reads low.

Your present hookup—using only one rectifier—might be okay. Check the voltage reading against another ac voltmeter to see if it is. A tube-tester filament supply is a handy source of variable ac voltage. If your meter doesn't read correctly, get a meter rectifier with a different polarity, as in Fig. 1-b, and try that.

You might be able to use a standard horizontal a/c diode, for a test; try it. This will give you the right series-shunt hookup. One rectifier is in series with the meter, and the other shunts the unused half-cycle around the meter (but doesn't cancel the first's output).

Now, for the resistors: your meter is not a true ac ammeter, with the meter in *series* with the circuit. Instead, to read watts you are putting a resistor in series with the circuit, and reading the ac voltage drop across this resistor with the ac voltmeter.

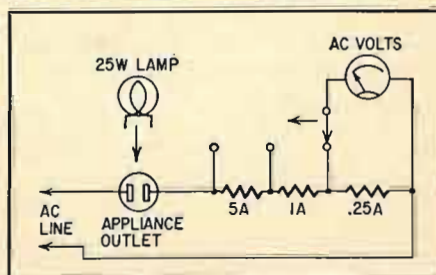

You can "cut and try" this method and get surprisingly close: Put a known load (say, a light bulb) in series with several resistors, across the ac line. (Fig. 2) For the 0.25-amp scale you'll need about 0.25–0.5 ohms, and the 1-amp scale will require about 1 ohm. A guess—better too small than too big!

Try these shunt resistors with a known load; start with the 0.25-ohm resistor, for in this hookup the smallest is in the circuit at all times (like a switch tuner). So, the little one has to be right, first; then you can work your way up the scales. For a small load, use a 117-volt Christmas-tree lamp of, say, 7 watts, which ought to give you a good near-center-scale reading. Use higher-wattage bulbs for the higher ranges. **END**

Radio-Electronics Is Your Magazine!

Tell us what you want to see in it. Your suggestions may make it a better magazine for the rest of the readers as well as yourself. Write to the Editor, RADIO ELECTRONICS, 154 West 14th St., New York, N. Y. 10011.

How to make a scene (that everybody will love you for)

a. With this Sony TV camera you can film almost any scene

b. Record it in both sight and sound with this Sony video tape deck



c. See and hear it on this large screen Sony monitor/receiver



Total cost of this
Sony TV Studio \$1340

It's as simple as A, B, C to enjoy this year's most enjoyable product, the home video tape recorder. You can produce instant movies in sound of memorable family events. Tape TV programs off the air. The compact, low cost Sony Videocorder® has hundreds of uses in business and education.

You can enjoy an hour's video tape for less than the cost of an hour of processed black & white film. There's no processing cost and you can erase and use the tape over and over again. It's instant movies in sound. This instant visit your Sony Videocorder dealer or write for details. The Videocorder is the only quality, low-priced video tape recorder available for immediate delivery. Sony Corporation of America, 47-47 Van Dam Street, L.I.C., N.Y. 11101

Products pictured above include: **A.** VCK-2000 Camera ensemble (solid-state camera, microphone, tripod) \$350. **B.** CV-2000D Videocorder deck, compact video tape recorder in handsome walnut-finish cabinet, \$695. **C.** Model CVM-2300U 22" (measured diagonally) monitor/receiver, \$295. *The Videocorder is not to be used to record copyrighted materials. Prices suggested list.*

SONY® VIDEOCORDER®

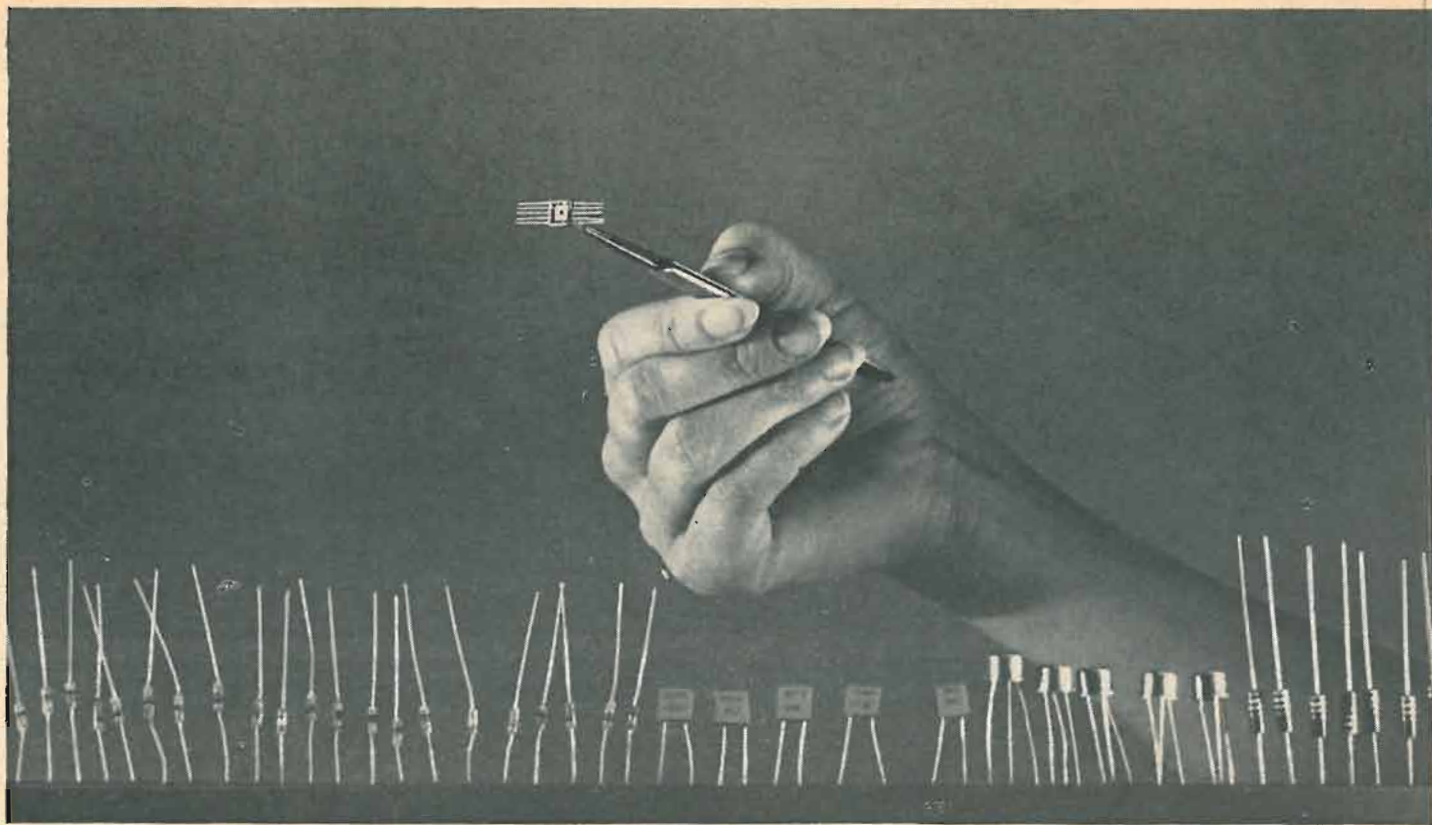

50 functions in a single chip. *The functions of 50 separate transistors, diodes, resistors and capacitors can now be formed by the tiny dot in the center of the integrated circuit held by the tweezers.*

The "Chip"

...will it make or break your job future?

THE DEVELOPMENT OF INTEGRATED CIRCUITRY is the dawn of a new age of electronic miracles. It means that many of today's job skills soon will be no longer needed. At the same time it opens the door to thousands of exciting new job opportunities for technicians solidly grounded in electronics fundamentals. Read here what you need to know to cash in on the gigantic coming boom, and how you can learn it right at home.

TINY ELECTRONIC "CHIPS," each no bigger than the head of a pin, are bringing about a fantastic new Industrial Revolution. The time is near at hand when "chips" may save your life, balance your checkbook, and land a man on the moon.

Chips may also put you out of a job...or into a better one.

"One thing is certain," said *The New York Times* recently. Chips "will unalterably change our lives and the lives of our children probably far beyond recognition."

A single chip or miniature integrated circuit can

perform the function of 20 transistors, 18 resistors, and 2 capacitors. Yet it is so small that a thimbleful can hold enough circuitry for a dozen computers or a thousand radios.

Miniature Miracles of Today and Tomorrow

Already, as a result, a two-way radio can now be fitted inside a signet ring. A complete hearing aid can be worn entirely inside the ear. There is a new desk-top computer, no bigger than a typewriter yet capable of 166,000 operations per second. And it is almost possible to put the entire circuitry of a color television set inside a man's wrist-watch case.

And this is only the beginning!

Soon kitchen computers may keep the housewife's refrigerator stocked, her menus planned, and her calories counted. Her vacuum cleaner may creep out at night and vacuum the floor all by itself.

Money may become obsolete. Instead you will simply carry an electronic charge account card. Your employer will credit your account after each week's work and merchants will charge each of your purchases against it.

When your telephone rings and nobody's home, your call will automatically be switched to the phone where you can be reached.

Doctors will be able to examine you internally by watching a TV screen while a pill-size camera passes through your digestive tract.

New Opportunities for Trained Men

What does all this mean to someone working in electronics who never went beyond high school? It means the opportunity of a lifetime—if you take advantage of it.

It's true that the "chip" may make a lot of manual skills no longer necessary.

But at the same time the booming sales of articles and equipment using integrated circuitry has created a tremendous demand for trained electronics personnel to help design, manufacture, test, operate, and service all these marvels.

There simply aren't enough college-trained engineers to go around. So men with a high school education who have mastered the fundamentals of electronics theory are being begged to accept really interesting, high-pay jobs as engineering aides, junior engineers, and field engineers.

How To Get The Training You Need

You can get the up-to-date training in electronics fundamentals that you need through a carefully chosen home study course. In fact, some authorities feel that a home study course is the best way. "By its very nature," stated one electronics publication recently, "home study develops your ability to analyze and extract information as well as to strengthen your sense of responsibility and initiative." These are qualities every employer is always looking for.

If you do decide to advance your career through spare-time study at home, it makes sense to pick an electronics school that specializes in the home study method. Electronics is complicated enough without trying to learn it from texts and lessons that were designed for the classroom instead of correspondence training.

The Cleveland Institute of Electronics has everything you're looking for. We teach only electronics—no other subjects. And our courses are designed especially for home study. We have spent over 30 years perfecting techniques that make learning electronics at home easy, even for those who previously had trouble studying.

Your instructor gives your assignments his undivided personal attention—it's like being the only student in his "class." He not only grades your work, he analyzes it. And he mails back his corrections and comments the same day he gets your lessons, so you read his notations while everything is still fresh in your mind.

Always Up-To-Date

Because of rapid developments in electronics, CIE courses are constantly being revised. Students re-

Tiny TV camera
for space and military use is one of the miracles of integrated circuitry. This one weighs 27 ounces, uses a one-inch vidicon camera tube, and requires only four watts of power.



ceive the most recent revised material as they progress through their course. This year, for example, CIE students are receiving exclusive up-to-the-minute lessons in Microminiaturization, Logical Troubleshooting, Laser Theory and Application, Single Sideband Techniques, Pulse Theory and Application, and Boolean Algebra. For this reason CIE courses are invaluable not only to newcomers in Electronics but also for "old timers" who need a refresher course in current developments.

Praised by Students Who've Compared

Students who have taken other courses often comment on how much more they learn from CIE. Mark E. Newland of Santa Maria, California, recently wrote: "Of 11 different correspondence courses I've taken, CIE's was the best prepared, most interesting, and easiest to understand. I passed my 1st Class FCC exam after completing my course, and have increased my earnings \$120 a month."

Get FCC License or Money Back

No matter what kind of job you want in electronics, you ought to have your Government FCC License. It's accepted everywhere as proof of your education in electronics. And no wonder—the Government licensing exam is tough. So tough, in fact, that without CIE training, two out of every three men who take the exam fail.

But better than 9 out of every 10 CIE-trained men who take the exam pass it.

This has made it possible to back our FCC License courses with this famous Warranty: you *must* pass your FCC exam upon completion of the course or your tuition is refunded in full.

Mail Card For Two Free Books

Want to know more? The postpaid reply card bound in here will bring you a free copy of our school catalog describing today's opportunities in electronics, our teaching methods, and our courses, together with our special booklet on how to get a commercial FCC License. If card has been removed, just send us your name and address.

ENROLL UNDER NEW G.I. BILL

All CIE courses are available under the new G.I. Bill. If you served on active duty since January 31, 1955, or are in service now, check box on reply card for G.I. Bill information.

CIE
Cleveland Institute of Electronics
1776 E. 17th St., Dept. RE-32, Cleveland, Ohio 44114

Accredited Member National Home Study Council
A Leader in Electronics Training... Since 1934



Designing With Integrated Circuits

It beats using conventional transistors or tubes

THIS ISN'T THE BEST TITLE. *Designing with signal processing packages* would probably be better . . . but the Editor says the title has to catch your eye.

The point is that engineers and experimenters can now work with signal-processing packages rather than discrete components. After years of miniaturization and microminiaturization, one technique has finally won the honors. This technique is the epitaxial/diffusion process by which a complete electronic circuit—in fact, several can be built on a tiny chip of single-crystal (monolithic) silicon.

One reason for the popularity of these monolithic integrated circuits, aside from space economy, is cost economy. RCA's CA3014, for example, is priced at \$3.15 each. In it are 12 transistors, 12 diodes, and 15 resistors. Just consider the cost of transistors alone. Some low-cost high-frequency transistors I know of sell at 40¢ each, and each one takes up the same amount of space as the entire CA3014.

Prices keep tumbling at almost unbelievable rates, and companies are packing more and more circuitry into each chip. The process has reached the point where external components cost more than the IC.

One serious question has concerned *who* would decide what goes into the IC. Some said the set maker, others the IC manufacturer. Also, the question has been raised whether microminiaturiza-

tion would trend to monolithic, thin film, or a hybrid combination. I believe the answers are beginning to emerge.

First: the IC manufacturers continue to develop new circuits at quite a rate. The circuits are fairly well standardized and have enough external connections left available that engineers can fit them to system needs. This way, circuits can be mass-produced and engineers can make best use of them.

Second: the trend is definitely to monolithic circuits. The most common packages for IC's are the multiple-pin TO-5 case and the dual-in-line packages (DIP).

Men are needed in the engineering, technical and servicing activities of this IC-oriented industry. The ones who'll be most successful are the innovators with a knack for seeing or making a market for the hundreds of new devices that are becoming available. However, you'll need to understand how designing with IC's differs from developing systems the old way.

Signal-processing-package approach

In the past, the normal approach to circuit design has been first to determine the input to the system and what output is desired. Then transistors of the proper gain, noise level and frequency range were chosen, and a general circuit laid out to achieve the desired result.

The next step was to calculate biases, and determine resistor sizes and current requirements. After all this was complete, the circuit was laid out in breadboard fashion for tests to determine whether the circuit would function. Next followed a period of adjusting biases, resistors, capacitors and the like to obtain exactly the result we wanted. We worked mainly with (discrete) *components*, making up a signal-processing package (which might be thought of as one functional block or stage in a complete block diagram).

Now, with integrated circuits, the story is something else. Most of the work is already done. We have a *signal processing package* that can deliver, under certain well defined circumstances, a given output over a given frequency range with a given input. The complete circuit package, often consisting of several stages, is ready to function with the addition of only a few external components and a little power.

So, if you work with IC's, you become a *system designer*. You determine what input will be used and what output you expect. You adjust feedback, compensation and other external configurations to achieve the desired output level and frequency response from the *signal processing package* (IC).

One of my first reactions to all of this was . . . what's left? The IC designers have done all of the work and left me with nothing to do.

If this were really true, there would be *one* device which you would simply stick into the circuit or string together in cascade to get what you want. That simply is not the case. Well over two dozen *low-cost* IC devices are currently available, and each functions a little differently from the next—has more or less gain, uses different power-supply voltages, requires different lead and lag compensation or covers a different band of frequencies.

Linear integrated circuit

Certain manufacturing limitations make it difficult to construct either large capacitors or large resistors on the monolithic chip. Although resistor tolerance values are very broad (in excess of 20%) and values generally low (under 10K), two IC resistors can nevertheless be closely *matched* by placing them near each other on the chip. Differential amplifiers, with low-value but closely matched resistors and matched transistors, are easy to make, so differential inputs are used for IC linear amplifiers more often than single-ended inputs.

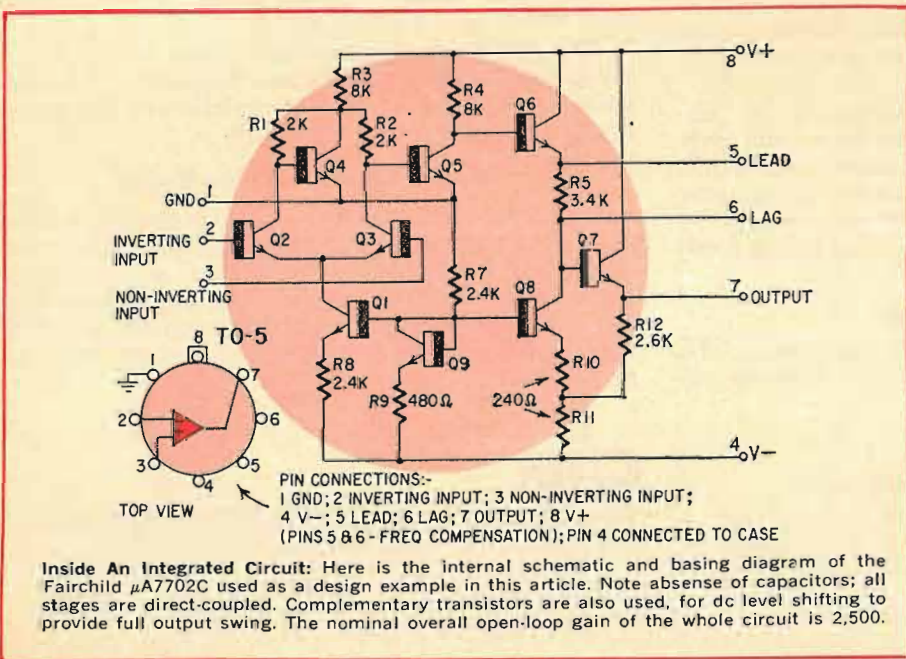

A differential amplifier requires two transistors which operate in opposing phase. If a signal is applied to both base terminals of a common-emitter differential amplifier, the output should be zero. How well a differential amplifier cancels a signal applied simultaneously to both input terminals (common-mode signal) is measured by its *common-mode rejection ratio*. In this same circuit, if one of the inputs is held at some fixed voltage and the signal is applied to the other, a "difference" output equal to the input signal times the gain will appear between the collectors.

Most linear IC's use direct coupling between stages to avoid coupling capacitors. Direct coupling also allows operation from dc to whatever upper frequency limit is imposed by other circuit characteristics. Many work well to 30 MHz and above.

Currently available IC's contain various differential-amplifier arrangements with outputs either single-ended or push-pull. Of the more than two dozen low-cost linear IC's listed on page 45, only two use both single-ended input and output.

Breadboarding and design

Some general precautions are useful in handling IC's. Leads from the package should not be bent excessively, especially at the point where they enter the header.

Interconnecting leads for compensation and feedback networks should be kept as short as possible. High gain means stray capacitance and lead inductance can cause parasitic oscillations.

Most of these devices are very rugged. They can stand momentary shorts and reverse voltages that are hard to believe, but I do not recommend mistreating them just to see what they will withstand.

Supplying dc operating power to an IC can sometimes be a little unusual. Some require power supplies with both a negative and a positive output. Most require equal voltages (i.e., +9 and -9) with respect to ground. A few will function acceptably with a single power supply.

In my first days with radio, we had little trouble with power-supply polarities. All voltage measurements were referred to ground. B+ was automatically understood to be a positive voltage with respect to ground. B- was nearly always understood as ground. C- was a voltage negative with respect to ground.

With transistors, it has become the practice to label one power-supply lead negative and the other positive without specifying which, if either, is common or ground. With IC's we must be cautious and return to the habit of labeling

or listing all voltages with reference to a common or ground point. We must always specify voltage with respect to some other point in the circuit. Fig. 1 shows how this works.

Some linear IC manufacturers use the symbols V_{EE} and V_{CC} to represent the negative and positive (with respect to ground) supply leads, while others use $V+$ and $V-$. So if a spec sheet calls for +9 volts on one terminal and -9 on another, the circuit requires two power sources with the positive lead of one and the negative lead of the other tied to ground. An alternative is an 18-volt supply, with a center tap to ground.

The capacitors shown are connected very close to the power pins of the device. They should be .01- or 0.1- μ F disc ceramics, and are used for power-supply decoupling—to prevent parasitics or motorboating that could creep in through feedback via the common power-supply impedance.

Since, as we've said, most linear IC's use the differential configuration, they have two input terminals and for the most part one output terminal. The inputs of many operational amplifiers are labeled "+" and "-". The "+" input will develop an inphase (noninverted) output and the "-" input will cause an inverted output (180° out of phase). They're called inverting and noninverting inputs.

Another factor you'll have to consider is feedback, because that is what controls the gain of an operational amplifier. To explain feedback in an almost oversimplified way, we can say that feedback applied from the output to the inverting (-) terminal will be degenerative and reduce overall gain, while feedback applied from the output to the noninverting (+) terminal will be regenerative and cause oscillation.

So far we have covered the main operating requirements of a linear IC: the power-supply configuration and voltages, power-supply decoupling, input arrangements, output and feedback. Most IC's have other leads available for various purposes. One is frequency-response compensation to adjust the gain-rolloff characteristic for circuit stability. How this lead and lag compensation is

accomplished will be covered separately. For now, we will consider how the monolithic IC processes the signal as a circuit package.

Designing the stage

Power requirements are determined from data sheets, and the hookup depends on the available power supply (battery or rectified ac). Frequency compensation will be made to obtain the desired frequency response. You can determine gain from the data sheets, so we are left with just a basic input-output stage or package with which to process the signals.

One manufacturer calls the operational amplifier a "circuit-activating device." Input impedance of the amplifier approaches infinity (which is the theoretical value) and output impedance approaches zero. Gain is almost infinite. Operation, therefore, becomes almost completely a function of the input, output and feedback circuits. For practical purposes, a very simplified formula can be used in most applications to secure results as accurate as most external components will allow.

Most IC's in the list on page 45 are not called operational amplifiers but those with differential inputs and single-ended outputs can be treated like operational amplifiers. The first step in designing any stage using IC's should be to specify what we want the stage to accomplish. Let's say we have a 10-mV signal (the output from some phono pickups) that we want to amplify to 1 volt to feed a power amplifier. Two or three transistors might give us good results, but in all probability we wouldn't achieve the con-

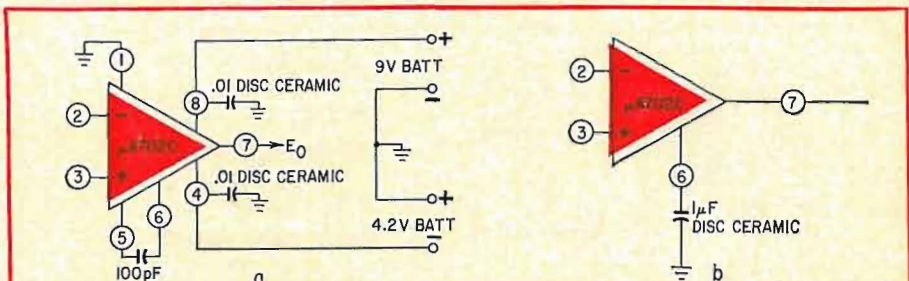
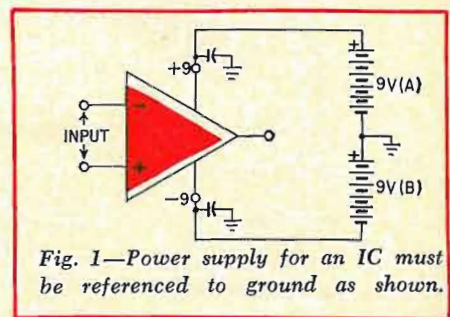

sistently low distortion and excellent response we can get from an IC amplifier.

Our amplifier is to be an audio amplifier, so we'll stretch the response to 200 kHz to insure good square-wave response. The Fairchild $\mu A702C$ (now $\mu A7702C$) is a wideband amplifier with high open-loop gain. With lead and lag compensation, it can be treated as an operational amplifier. Design can proceed using the same formulas that apply to operational amplifiers. So let's work out our preamp, using the $\mu A7702C$.

First, taking our cue from the manufacturer's specifications and the basing diagram, we will apply power for battery operation—9 volts to pin 8 and -4.2 to pin 4 (Fig. 2-a). Include a pair of small disc ceramic decoupling capacitors right at the pin terminals. The case of the $\mu A7702C$ is tied to pin 4 electrically, so it will be -4.2 volts "hot" with respect to ground.

Next, pin 1 is to be grounded, says the basing diagram. Pins 5 and 6, we find, are used to compensate the ampli-

fier for stability. The response of most general-purpose operational amplifiers is rolled off at the rate of 6 dB per octave above 350 Hz to insure stable operation. Linear IC's must be rolled off externally.

In the case of the $\mu A7702C$, open-loop (no feedback) rolloff starts at 7 MHz and is rated at 12 dB per octave. With gain decreased by feedback and with proper compensation (determined from the data sheets), the amplifier can be used to 30 MHz.

Interaction between gain and rolloff makes it impractical to determine compensation without actually trying the circuit. So, if your amplifier oscillates, one consideration should be the lead-lag rolloff components.

The spec sheet gives some additional information on the $\mu A7702C$. For a dc instrumentation amplifier, a single 0.1- μF disc ceramic capacitor from the lag terminal (pin 6—Fig. 2-b) to ground will cause correct rolloff for dc and very-low-frequency ac. Instead, since

we want wide bandwidth, we use the lead terminal (pin 5). A 50- to 100-pF capacitor between pins 5 and 6 will spread the response to the full 30-MHz range.

The response we want for our preamp is 0 to 200 KHz with gain of 100. Compensation values—selected from the data sheets—were originally 2,000 ohms and 100 pF (R_1 and C_1 in Fig. 3) connected to the lag terminal. In the final model, the resistance was reduced to 100 ohms because the amplifier tended to oscillate at low gain. Even with that low value, the amplifier will oscillate at 1 MHz at gain levels below the lowest setting for audible output. Since 1 MHz is not audible, no effort was made to eliminate this oscillation.

The basic idea behind this approach so far has been to design circuitry for those pins that represent auxiliary parts of the circuit, leaving a device that requires only input and output consideration. The easy-to-use formulas in the figures are simplifications of much longer formulas. They ignore the fact that both open-loop gain and input impedance (Z) are always something less than infinity and that output Z is never actually zero.

Particularly interesting is the formula in Fig. 4 that relates closed-loop gain (A_V) to feedback resistance R_F . It turns out that gain equals R_F divided by input resistance R_S . The R_S is usually replaced by Z to indicate impedance. So, if input impedance is 1K, gain will be 10 with a 10K feedback resistor and 100 with a 100K feedback resistor.

If in doubt about the source impedance (R_S), put in a precision resistor at R_F , apply a signal to the amplifier from the source in question, and measure the gain. R_S will equal R_F divided by the gain.

The preamp stage we have achieved (Figs. 4 and 5) has a modest overshoot on the leading edge of a negative-going square wave and, as mentioned earlier, will oscillate at extremely low gain settings. Other than that, square-wave response is very good and sine-wave response is nearly perfect.

Either preamp would drive a power amplifier with more than adequate gain for a variable-reductance cartridge. A ceramic cartridge would overdrive the stage, but a lower-value feedback resistor could be used to decrease gain.

With a little reading and experimenting, you will find the world of monolithic integrated circuits infinitely fascinating. The field of low-cost IC's is so new the surface has only been scratched. The rapid commercial advance and adaptation of IC's to consumer products is almost beyond belief. If you learn even the basics of how to design with IC's, you can put them to work in new devices of your own imagination. END

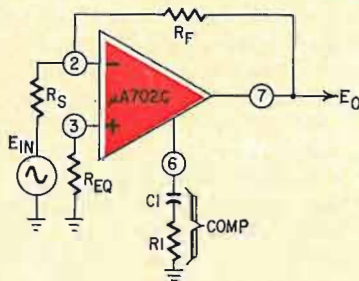

FOR COMPENSATION:-
 $R_1 = 20(1 + \text{GAIN}) \text{ OHMS}$
 $C_1 = \frac{.01}{1 + \text{GAIN}} \mu F$
 FOR 200 KHZ BANDWIDTH:-
 $R_1 = 20(1 + 100) \text{ OHMS}$
 $= 20 \times 101 = 2020 \text{ OHMS OR } 2K$
 $C_1 = \frac{.01}{101} \mu F \text{ OR } 100 \text{ pF}$

Fig. 3—How to design desired frequency response into the IC audio preamplifier.

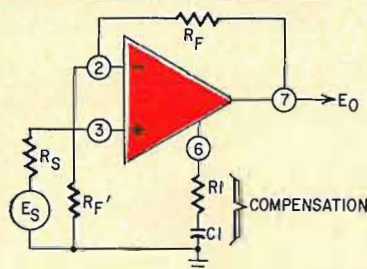

VOLTAGE GAIN:
 $A_V = \frac{R_F + R_F'}{R_F'}$
 FOR MINIMUM OFFSET:
 $R_S = \frac{R_F R_F'}{R_F + R_F'}$
 OUTPUT OFFSET VOLTAGE:
 $\Delta E_O = V_D \left(1 + \frac{R_A}{R_F'}\right) + I_D R_F$

A_V = VOLTAGE GAIN
 E_O = OUTPUT VOLTAGE
 E_S = INPUT SIGNAL
 R_S = SOURCE RESISTANCE

R_F = FEEDBACK RESISTANCE
 V_D = INPUT OFFSET VOLTAGE
 I_D = INPUT OFFSET CURRENT

Fig. 4—Circuit gain is a function of feedback, set by value of feedback resistor.

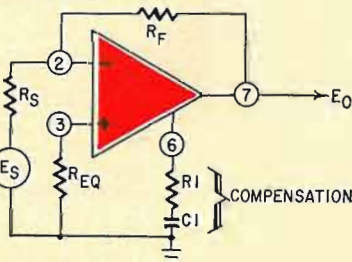

VOLTAGE GAIN
 $A_V = \frac{R_F}{R_S}$
 FOR MINIMUM OFFSET
 $R_{EQ} = \frac{R_F R_S}{R_F + R_S}$
 OUTPUT OFFSET VOLTAGE
 $\Delta E_O = V_D \left(1 + \frac{R_F}{R_S}\right) + I_D R_F$

Fig. 5—With this connection, noninverting circuit of Fig. 4 becomes inverting.

Tools and Tests for Transistor TV

Little-bitty video means big-big problems unless you scale those problems down. Think small, work close, and use small-size tools

By JACK DARR

INDISPUTABLE FACT NO. 1: TRANSISTOR TV sets are hard to work on. Indisputable Fact No. 2: Transistor TV sets are here, in growing numbers, and we've got to work on 'em.

You can work on them, find trouble, fix them, and make money at it, if you use the right tools and techniques. Here are some practical hints and test methods, worked out at the test bench. Not only from my own bench, but from peeking over the shoulder of some real transistor servicing hot-shots.

The right tools

Big vacuum-tube receivers have lots of chassis room, and using big tools in 'em is no sweat. But tiny solid-state TV means we're going to be working in very close quarters. Tools *have* to be small, so there's room to use them. You can't fix a watch with blacksmith's tools.

The tool most of us use most often to *find* trouble is a test prod, hooked up to a vtvm, vom, scope, etc. Wait a minute? A *vivm*? For transistors? Yep. Despite what it says in the books about transistors being "current amplifiers," we are still going to take *voltage* readings. Voltage tests are faster, for we don't have to break the circuit to make them. Until someone repeals Ohm's law, the voltage across a circuit will still be in direct proportion to the current. So initial checks, at least, will still be good old voltage measurements.

Getting these readings is the prob-

lem. The itsy-bitsy TV's are nearly all printed circuit, and these PC boards are covered with insulation, plastic, varnish, etc. Test prods must have sharp points to get through the coating and into the conductor. Also, the rest of the prod must be well insulated, to prevent accidental shorts to other circuits. Quite a few types of test prod do this work nicely: The photo shows several. The two skinny prods have insulation all the way to the tips. The spring-loaded hook-tip prods can be used two ways: With the hook retracted, they can be used as points to pierce insulation. Push a button on the handle and the little hook comes out; it can be clipped on wires and leads, and will stay.

Next is the old faithful needlepoint, in a standard-size prod. It uses a steel phono needle that can be replaced when it gets dull. The scope probe shown has been insulated with short pieces of spaghetti; it has a spring-clip needle tip.

Finally, notice the miniature alligator clips, with the insulators put on both ways. Jumpers using these clips are very useful—you can clip one end to a test point and the other to the tip of a scope probe lying on the bench. This gets away from having to hold or fasten the heavy probe inside the tiny chassis. Alternative: a short lead with clip on one end and long test prod of any type on the other.

Even with small, sharp-pointed prods, there are problems in making test measurements. There are PC boards

and there are PC boards. Many makers cleverly clip off all the wire ends at board connections, so that you have nothing but solder blobs to clip to. Some manufacturers leave short pigtailed on the leads, which are handy. If there aren't any, add some.

Take about 6 inches of bare No. 20 hookup wire, and tack-solder an end to a place you want to check. When it sets, clip it off leaving about ¼ inch of wire. Then, go on to the next. This takes about 2 to 3 seconds each time, by actual check, and is *very* helpful! If you want to, bend a tiny hook or loop in the end of each pigtail; this'll hold the clips or test prods better. These pigtails can be left on the board without bothering a thing.

Apart from test prods, most hand tools ought to be small, too. See the photo for a few examples. The small diagonals are very useful for getting into tight places; so are the two pairs of small long-noses. The thin locking pliers are copied from surgeon's hemostats and sold in parts houses. They're good for getting into narrow places to retrieve that screw you dropped. They're also nice for holding tiny parts while soldering. The jeweler's screwdriver is a must for the tiny screws used in tiny TV's.

Socket wrenches (nut drivers) are available now as small as ¼ inch, and they're sure handy! The nut-holding type can save a great deal of time; an internal magnet or clip holds the screw or nut. A screw-holding screwdriver is another time-saver in places where you have to hold the set with one hand and start a screw with the other. It makes the number of hands and jobs come out

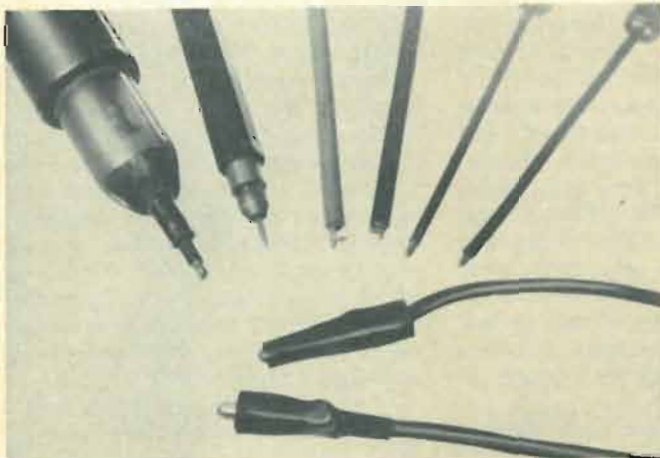

The indispensables of tiny-TV service—small prods and clips.

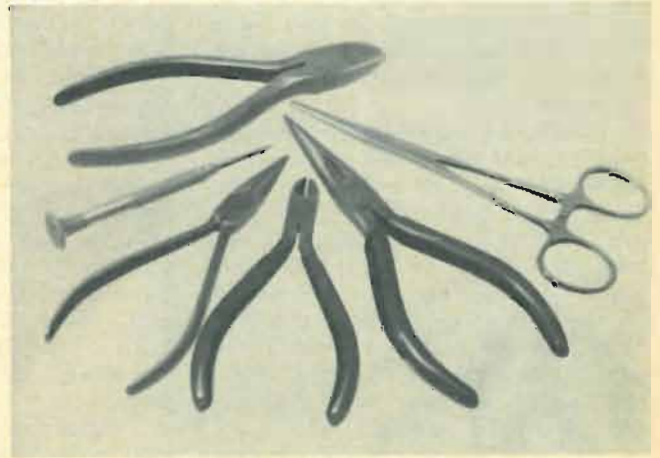

A tightly crammed chassis requires small tools for service.

even and prevents headaches.

A small soldering iron is a necessity. Get one with a fairly long, thin barrel. Why? Well, there will be lots of times when you have to go deep down inside a narrow space and unsolder a joint, without burning up everything else you pass along the way. You can make up special tips for the old faithful solder gun: Slip a couple of pieces of asbestos or fiberglass tubing over each side, leaving only the tip exposed. This tubing can be bought from appliance dealers or any place where they repair electric irons or heating elements. If you need a longer tip, make one up from a piece of bare No. 4 or No. 6 copper wire. You can use tips as long as 4 inches. Be sure to get good tight connections, because these tips will take a little longer to heat up. An iron shouldn't be *too* hot for this kind of work, anyhow.

Another useful tool is a magnifying lamp. I mean the kind with a circular fluorescent bulb and a good-size magnifying glass in the middle. One of these is also nice for tuner work in big receivers (so are the wee tools!)

There are quite a few other special tools that come in awfully handy for this fine work. Keep a sharp eye out whenever you go to your distributor's store. Few small tools cost more than a buck, and all are worth the price in time saved.

Localize troubles

Now we come to the hard part—finding the trouble. Repairs aren't hard to make, but testing and making the diagnosis is usually rough. One reason is the difficulty in identifying parts and stages. Let's look at a few more indisputable facts. Teeny-weeny receivers are very hard to get at. We can't pull the chassis and have all the test points exposed as in older tube sets. So, what to do? We learn to use all the *short-cut tests*; in other words, the ones we should have been using all along! We test the set by checking *functions*. When we find a function that isn't working, then we check *stages*. Eventually we wind up checking *components*. (If you think this is a new method, just remember that some of us were using it back in 1933 on radios!)

There are surprisingly few functions in a TV set: power supply, horizontal and vertical sweep, and the signal paths: video and sound. Five, all told. Look at the set in operation, and question the customer, and you ought to have a good idea of where to begin. Of course, brace yourself for answers like: "Well, it works pretty good but it falls out of horizontal sync about every three days!" (This is what engineers call "worst-case" testing!)

In these sets, service data are very important—as a time-saver in *locating*

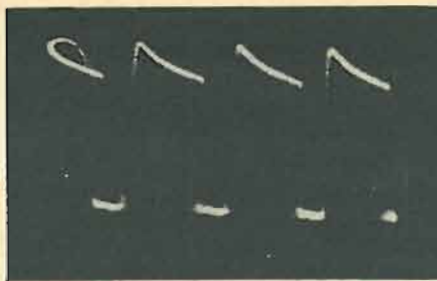

Fig. 1—Typical voltage waveform at collector of horizontal-output transistor.

parts, mostly. We still have the old questions, "What part is it, and where is it on the chassis?" Especially on crowded PC boards, this becomes most important. You can always find a few key points, such as the tuner output or i.f. input, high-voltage lead, video output and so on, but this can take up a lot of time. And you have to identify stages by parts. The idea is to get to the stage with the least delay.

Sometimes, if you don't have the data for one model, you will have it for another made by the same people, and you'll be able to find enough similarity in construction to help out. (This is another practice that goes back to radio days!) Also, you'll find that designers tend to use "typical" circuits in several models. So, even if the rest of the set doesn't match the circuit you need, the horizontal, or the vertical or the sound, etc. may be identical.

You can also get some dope by checking the power supply. Look for big filter capacitors and power rectifiers, by following the ac line cord through the power transformer. You can follow a video signal by starting at the CRT cathode and tracing back. This will get you to the video output transistor, a good checkpoint. Go through this stage and the first video, and you can locate the video detector. Inject an af signal here, watching the screen for bars, and you'll be able to clear up these two stages in short order.

Notice that we're dusting off one of the oldest test methods in the business, outside of dc voltage measurements? Sure, signal tracing. There's a darn good, logical reason for this. Small TV chassis construction makes our favorite disconnect-and-check technique impractical. So, we must locate the defective function first, then make more detailed tests to find the defective stage. Then we can start disconnecting and checking! If we don't get a pretty close fix on the cause of the trouble, we're going to be wandering around in that maze of conductors and semiconductors like Hansel and Gretel for a couple of hours!

Signal tracing's not hard. All you need is the right equipment, which you should already have. A signal source

can be an rf generator or, better still, a color-bar generator. It makes a lovely unmistakable pattern on the scope and has its own sync. Also, something is needed to detect the presence or absence of the test signal, and that's the scope. Feed the bar-dot signal into the antenna, and follow it through the tuner and i.f. with a crystal-diode (demodulator) probe, then use the direct probe and follow it on to the picture tube. This is also the *only* instrument that will let you check for the presence or absence of sync at any given point in the circuit.

In transistor TV horizontal and vertical output circuits, we're going to have to use the scope. We don't have the trapezoid waveforms of tube circuits; transistor sweep outputs are all driven by *shaped pulses*! Fig. 1 shows the horizontal drive pulse from an RCA KCS-154. The ratio of on to off time must be set with a scope, by adjusting the horizontal oscillator coils. This turns out to be a simple job, *if* you follow the instructions. Fortunately for us, most of this circuitry is low-impedance, so the waveforms we get on our service-type scopes are going to look a lot more like the ones on the service data!

Voltage and parts testing

When we locate a stage that isn't working, *then* we stop and make detailed tests: voltages, transistors and other components. As far as operating voltages are concerned, we're still going to have to go to the service data, for a while yet anyhow. There isn't enough standardization to give us a set of "typical voltage readings" for, say, an i.f. amplifier stage, and so on. In imported sets without service data, the signal is still common to all stages, and we can use it to find a stage that isn't working. Then we take the stage apart, and find out what kind of transistor is used. Resistor values can be checked by the color code. Desperate measures, yes, but they're about all we can do.

Valuable hint in transistor-stage checking: A lot of hot-shot transistor men and factory service engineers habitually check the *emitter* voltage first. I mean when they're going through something like an i.f. strip. Fortunately for "our side," common-emitter circuits are very popular. These all have emitter bias resistors—low value—and most are bypassed to help frequency response or control feedback. If the bias is wrong, or particularly if the transistor is shorted, up or down goes the emitter *voltage*. So, if you find a stage with too much or no emitter voltage, stop and check it out. Fig. 2 shows how.

A good transistor tester will be very handy. In-circuit testers will give you an accurate reading on the condition of a transistor *without* taking it out.

The worst headache we've got seems to be that old question, "Is the transistor good?" If we know this, then we can go on to other stages, or stop and check into this one: resistors, voltages, etc.

In these solid-state circuits, you can use our old favorite method, parts substitution, but you'll have to change the procedure a little. *Don't* bridge filter capacitors, etc., with *power on*. You'll take the chance of causing a current surge or voltage spike, either of which can pop a perfectly good transistor in a split second. Since transistor stuff has no warmup period, you're not going to lose time by turning it off, clipping the test part in and then turning it back on. A pair of 6-inch test leads with miniature clips is very handy; clip to the capacitor, and then to the circuit. Leave the big, heavy capacitor on the bench out of the way. If you use a "parts substitutor," as I do, you can change the big alligator clips that came on it to the miniature type. The little clips are safer.

The common problem

In better transistor TV sets, you'll find some kind of voltage regulation in the power supply. The voltages will be different, but the principles and tests are the same as for any power supply. Some use Zener diode regulation, as in Fig. 3. Others use transistor regulators. In some cases, you'll even find circuits with series regulator transistors, controlled by a separate error-amplifier transistor. Its emitter is usually clamped by a reference Zener, as in Fig. 4. Also, you'll find this same type of circuit with a higher-voltage Zener and a regulated 12 volts taken off the reference diode.

Basically, all these regulators work the same. They put the collector-emitter junction of a power transistor in series with the supply line. Then, the supply voltage is regulated by the variation in the resistance of this junction—in other words, the current flow through it. Current flow is controlled by the base volt-

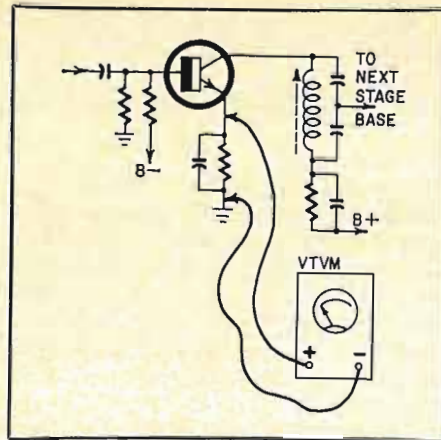

Fig. 2—In a common-emitter i.f. amplifier, check emitter voltage first. If it's too high or absent, the transistor's bad.

age (the bias), which comes from a tap on a voltage divider across the output.

When the regulated voltage goes down, due to heavier current drain, the base voltage of the error-amplifier transistor changes. This makes the bias of the regulator transistor change and allow more current to flow; the voltage comes back up. Notice that we didn't mention any polarity of this change; you'll find both npn and pnp transistors used, and the voltages will be opposite in polarity. If you want to check up on other circuits, look in RCA's *Transistor Manual SC-10*, pages 292, 293 and 294. Lots of regulators there.

The control action of a regulator circuit can be made very fast. So fast, in fact, that it will actually serve as a filter! It will not only remove slow voltage changes, but also take out 60- or 120-Hz ripple. You'll find some of these circuits called *capacitance multipliers* because they act like very large filter capacitors.

Voltage regulators are simple to test—just read output voltage. If it's the rated value, it's okay. If you have any doubts, move the voltage-adjust control

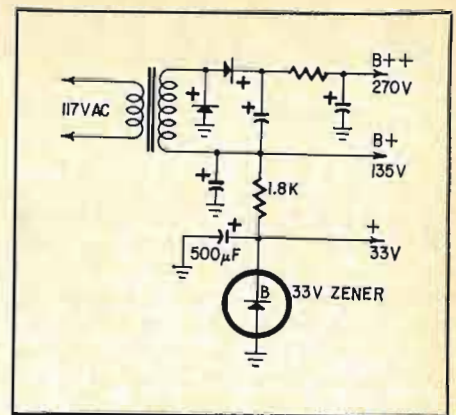

Fig. 3—A solid-state power supply for a solid-state receiver. Note the two B+ voltages that aren't regulated. The 33-volt line is direct-regulated by a Zener.

and see if the output voltage goes up and down. Alternately, vary the ac input voltage to the power transformer and see if the regulated output stays at the right value.

If you suspect the regulator, disconnect the load, and take a reading. The open-circuit voltage should be exactly the same as the full-load voltage. These regulators will hold the voltage up even if there is a small leakage in the load.

However, if there is bad leakage or a dead short, such as a shorted transistor somewhere in the load, the circuit breaker or fuse will usually kick out. Disconnecting the loads one at a time and resetting the breaker each time will tell you. If the voltage comes back up to normal, then there's a short in the load. Current measurements in the various high-current circuits, the vertical and horizontal sweeps and the audio output, will usually fix the cause. The most common cause is one or more shorted transistors. Be sure to check out all the bias resistors *before* you shove a new transistor into the circuit! Most transistor shorts will burn up the emitter resistor.

To check a Zener diode, just read the voltage across it. The Zener voltage will be given in the parts list, or check the schematic for the value. You can check a Zener for open circuits with an ohmmeter. Or vary the voltage-adjust control of the regulator, while checking the voltage directly across the Zener. If this voltage *changes*, look out. The Zener is probably open. You'll find Zeners listed in catalogues by the nominal or working voltage, from about 1.2 volts on up.

So, there you are. To sum up, get the correct-size tools. Learn to use localizing tests, to first pin down the trouble area, then the individual stage, and finally parts. It'll be rough for a while, but we'll probably think nothing of it in a few years! [We'll have new problems to worry about then.—Editor] **END**

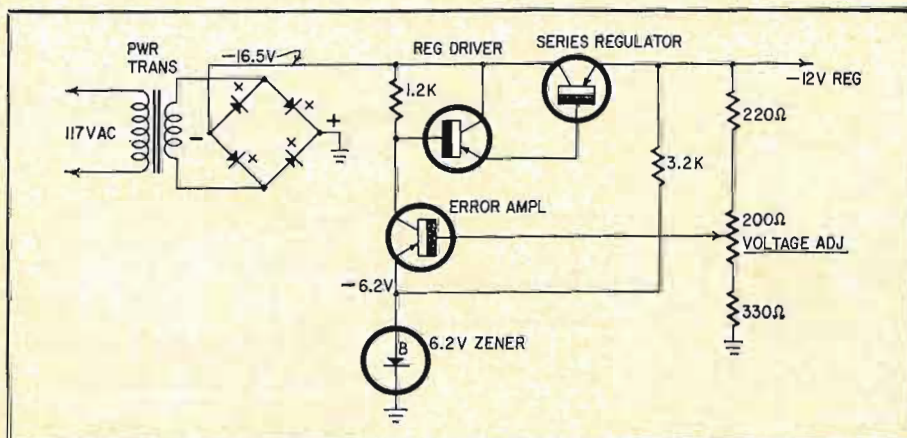

Fig. 4—This three-transistor voltage regulator also acts as an electronic ac ripple filter. The Zener provides a reference voltage for the emitter of the error amplifier.

A PORTABLE COLOR RECORDER

Newest type of helical-scan video tape machine has been colorized

By JOE ROIZEN*

RECORDING COLOR TELEVISION SIGNALS on magnetic tape has been practical since 1958 when the first compatible color broadcast recorders went into service. These transverse studio machines use four heads which rotate at right angles to tape travel (see Fig. 1). The machines also contain very complex circuitry and time-base correction devices. The circuits are necessary to achieve studio-quality NTSC playbacks that meet FCC specifications for on-the-air transmission; such VTR's (video tape recorders) range in price from \$40,000 to \$100,000.

The development of inexpensive helical videotape recorders (Fig. 2) for monochrome industrial and home applications, coupled with the current color boom, has led to investigations into relatively simple, inexpensive ways to colorize these recorders. The *pilot-carrier* principle has proved a suitable system. Modifications to a normal monochrome recorder (Ampex VR-7000) and a home color receiver make it possible to record and play back color programs with a fidelity approximately equal to off-air home reception.

The time-base problem

The NTSC color signal is composed of interleaved monochrome and chrominance signals amplitude-modulated on an rf carrier. The monochrome portion of the video signal requires only that the horizontal sync coming from tape have less than a 0.15% per sec² rate change for stable monitor images. This is a fairly large and easy-to-meet requirement for modern videotape recorders with head-drum servos. The chrominance portion, however, has a subcarrier signal of approximately 3.58 MHz. The instantaneous phase of this subcarrier determines hue in the reproduced image. One cycle of the subcarrier (360°) has a

0.279- μ sec period, and a 10° error in subcarrier phase will produce a noticeable hue shift. 10° represents only about 8 nsec. Allowing for the accumulation of record and playback errors, a time base of better than 4 nsec is needed to reproduce faithful color pictures. Such an extremely fine time base is not easy to attain.

Any rotating mechanism is subject to undesirable movement due to mechanical and electrical eccentricities, dynamic imbalance, walking bearings, etc. The head-drum assembly in a VTR will normally display such variations in angular velocity as a time-base displacement of the reproduced signal. A monochrome

picture may exhibit slight jitter, which is usually masked by the flywheel effect of the horizontal sync circuit of the home receiver. But when color is added, the rotating-head displacements show up as constant changes in subcarrier phase and the image looks as though it has lost color synchronization.

The pilot-carrier principle

The composite color signal used for recording in the VR-7000-A (the color version of the VR-7000) is also fed to a burst separator which phase-locks a crystal oscillator running at the color subcarrier frequency (see Fig. 3). The output of the crystal oscillator is divided by 7 in a tuned circuit that yields 511 kHz, as shown in Fig. 4. The 511 kHz is then multiplexed at a 5% level onto the FM signal applied to the recording head. The current through the head then has a 5% pilot-carrier content. The level must be high enough to be detectable in the playback circuits yet low enough to minimize interference visibility in the reproduced image.

In playback (Fig. 5) the 511-kHz signal is recovered at the head preamp output, and a bandpass filter isolates it from the FM signal carrying the video information. Two limiters amplify and clip the signal to a uniform level; the pulses now drive a Schmitt trigger whose square-wave output goes to a second bandpass filter centered at 3.58 MHz, the 7th harmonic of the 511-kHz pilot carrier. The 3.58 MHz is amplified and fed out of the recorder to the chrominance demodulation circuits of the modified home receiver. The set's own quadrature circuits form the 0° and 90° signals to decode the color information.

Since the pilot-carrier signal is subject to the same time-base displacement errors that the composite video signal is experiencing, the time relationship be-



A typical broadcast video tape recorder.

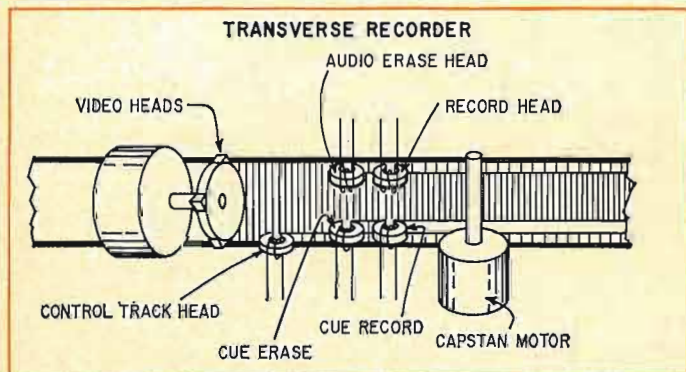

Fig. 1—Broadcast-quality VTR uses transverse scanning.

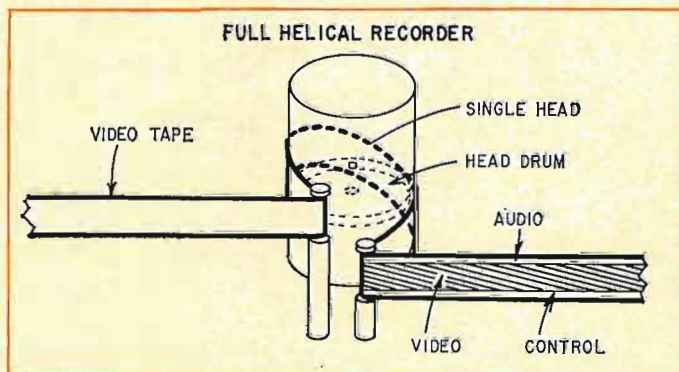

Fig. 2—Standard industrial video recorder has helical scan.



Ampex VR-7000-A can record and play back tapes in either color or black and white.

tween the pilot carrier and the desired signal remains constant. Hence the color signal can be decoded with reasonable time-base accuracy. The local oscillator in the color receiver is temporarily deactivated during VTR playback.

Recorder operation

The signal system of the VR-7000-A (Fig. 6) must be capable of handling a bandwidth of at least 4.2 MHz to not attenuate the color sidebands. To eliminate unwanted noise, spurious high-frequency signals, etc., the input is filtered by a phase-linear 4.5-MHz low-pass filter network.

A fast-switching multivibrator-type modulator converts the video signal to FM. The carrier and deviation frequencies are somewhat elevated from their monochrome counterparts to minimize intermodulation effects between the FM signals and the high-energy color subcarrier (Fig. 7). The modulator operates between 5.5 MHz at sync tip to 6.6 MHz at peak white. A rising pre-emphasis going up to 14 dB at the color subcarrier improves signal-to-noise ratio and differential gain and phase. The FM signal goes to a head-driver amplifier

which provides a constant-current source to the recording head up to 15 MHz. A rotating transformer with an 8-to-1 ratio transfers the amplifier output to the transducer. A 50-microinch head gap is employed.

In playback (Fig. 8) a low-impedance preamp gives a flat frequency response. Aperture correction and equalization are applied to the FM signal before 50 dB of shunt limiters eliminate variations in signal amplitudes.

The output of the limiter is a constant-amplitude FM signal. A pulse-count detector and a 4.2-MHz phase-linear low-pass filter convert the signal back to video and remove residual carrier and deviation components. The output amplifier feeds two 75-ohm outputs, and the monitor (receiver) must be "jeeped" (rf and i.f. stages bypassed) to provide direct access to the video circuits.

Further development of a heterodyne signal-processing system will eliminate the need for modifying the home receiver. At that time it will be possible to modulate the composite video signal on a carrier and feed it into the set through the antenna terminals on an unused channel.

A color-kill circuit in the VR-7000-A detects the presence of bursts on the input signal and activates the pilot carrier in the record mode. If no burst is present, the pilot carrier is shut off so that the recording will not contain the 511-kHz signal. Under certain background conditions, faint vertical lines can be seen in the playback image due to interference from the pilot carrier. The level, however, is not high enough to be objectionable and with normal image conditions, is not noticeable.

The colorized VR-7000-A produces acceptable color pictures for most non-broadcast uses, such as educational, industrial and home applications. END

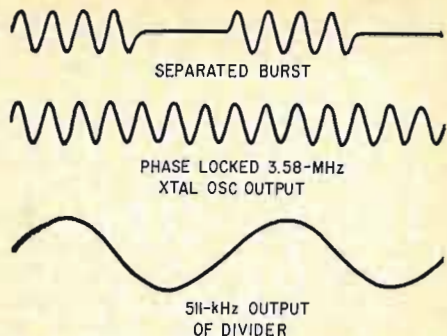

Fig. 4—The burst-to-pilot relationship.

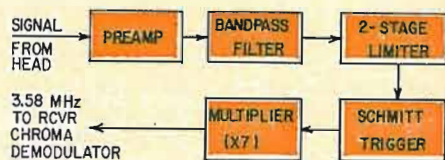

Fig. 5—In playback, pilot produces burst.

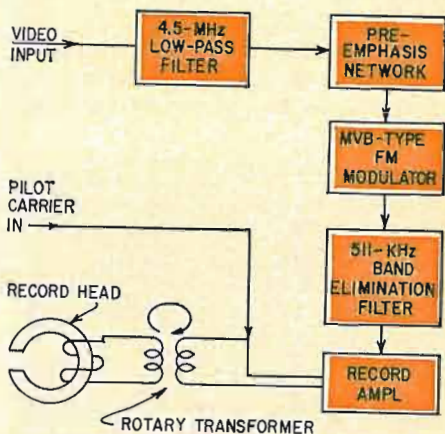

Fig. 6—The VR-7000-A in recording mode.

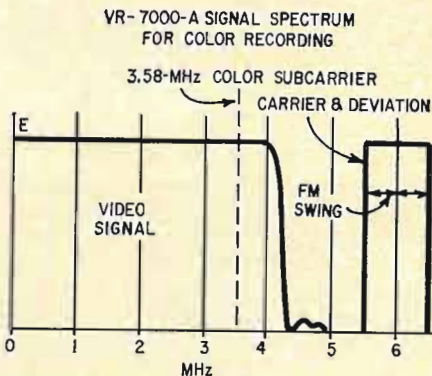

Fig. 7—The color recording bandwidth.

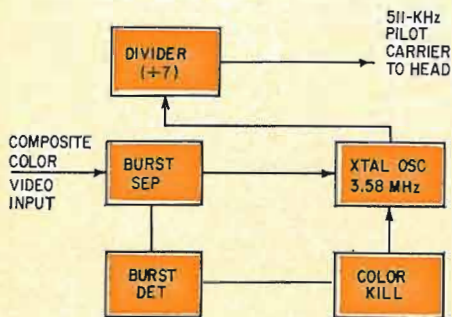

Fig. 3—Pilot carrier is manufactured from the 3.58-MHz reference-oscillator signal during the recording process.

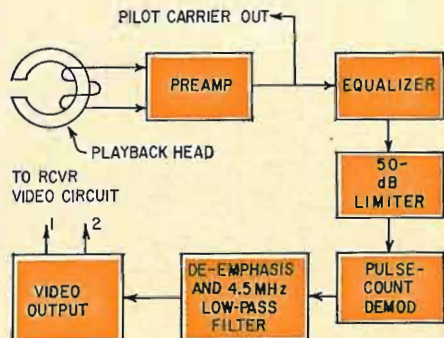

Fig. 8—Playback function of VR-7000-A.

High-Impedance Transistor Mixer

How to convert an older transistor mixer for use with hi-Z mikes—
or work up your own mixer design

By W. FORD LEHMAN

THE CIRCUIT OF FIG. 1 SHOWS A SIMPLE, basic way of making a transistor show a high impedance to an audio source. This *emitter-follower* (or common-collector) circuit is the semiconductor version of the tube *cathode follower* (common plate). Its input impedance is roughly the value of the emitter resistance (R_3 in Fig. 1) multiplied by the current gain (beta) of the transistor. If the follower circuit works into a load much greater (10 or 20 times) than the value of R_3 , the input impedance of the follower stage can be between $\frac{1}{4}$ and $\frac{1}{2}$ megohm, shunted by base-bias resistor R_1 . Larger values are possible with high-gain, low-leakage transistors and high values of emitter and base resistance.

The voltage gain of the follower circuit is less than 1, but not *much* less.

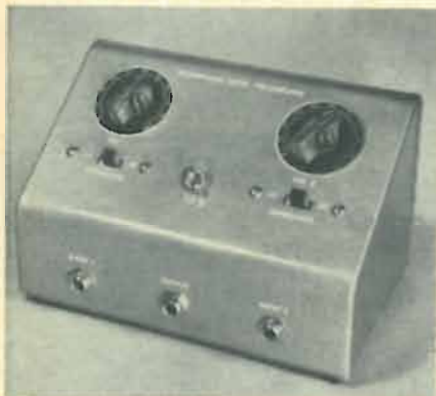

Ordinarily, that's a small sacrifice for winning a higher input impedance.

I first used this particular circuit with a two-channel mixer described in the March 1963 *RADIO-ELECTRONICS*. The mixer circuit supplied plenty of gain, but its input impedance was only 1,000 ohms—too low for many audio signal sources. Adding this follower circuit solved that problem.

The unit I built, shown in the photos, has switches for cutting the emitter follower out of the circuit so that the mixer can be used as originally intended—with low-impedance sources. Any three-pole double-throw switch will do (I used four-pole double-throw slide switches, Continental-Wirt G342). I made a dummy panel for the controls, jacks and switches, so the "works" of the mixer are self-contained and can be removed from the cabinet without a great deal of fuss.

My particular application for the mixer was to blend the separate bass and treble pickups on my accordion for feeding to a monaural tape recorder. But the circuit is equally useful for any recording or PA job in which you want to mix two signal sources.

[*Editor's note:* If you can tolerate the 10% or-so signal-voltage loss from the emitter follower, you can make an even simpler mixer as shown in Fig. 2. An unlimited number of inputs can be tied together this way, but the values of

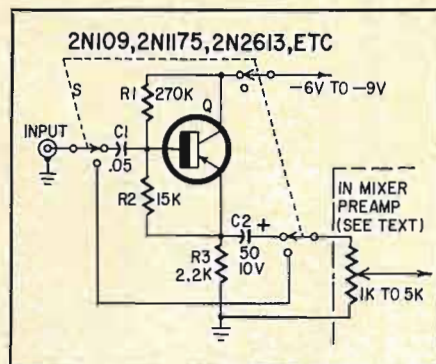

Fig. 1—Circuit of an emitter follower the author used to step up input impedance of a mixer described in *R-E* for March 1963.

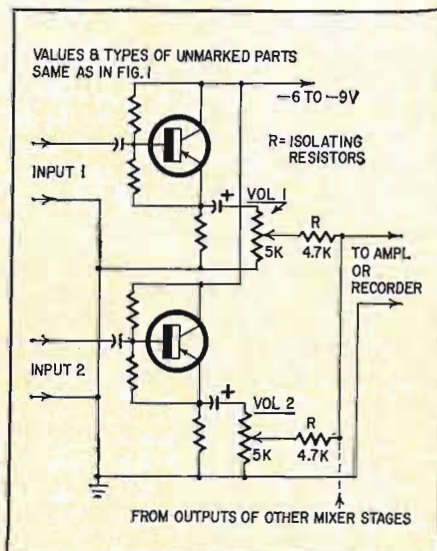

Fig. 2—Using the basic emitter followers in a simple passive resistance mixer. See text for explanation of circuits operation.

all the mixer pots should be the same, as should the values of the isolating resistors. If you use an emitter follower at each input, you have a mixer with medium-high-impedance inputs and a medium-low-impedance output. That's ideal for many operations.

Noise from transistors and resistors may make this gainless circuit impractical for high-quality work with low-output microphones. It's best to stick to fairly high-output crystal or dynamic mikes, or high-level sources like the outputs of tuners, tape recorders or crystal phono pickups.]

C1—.05 μ F, paper or ceramic
C2—50 μ F, 10 volts, electrolytic
Q—germanium pnp high-gain audio transistor: beta around 100 (2N109, 2N1175, 2N2613, etc.)

R1—270 K
R2—15 K
R3—2.2 K

These resistors can be $\frac{1}{2}$ -watt, 10% types, but hiss will be lower with deposited-carbon or metal-film type.

S—3-pole double-throw switch (see text)

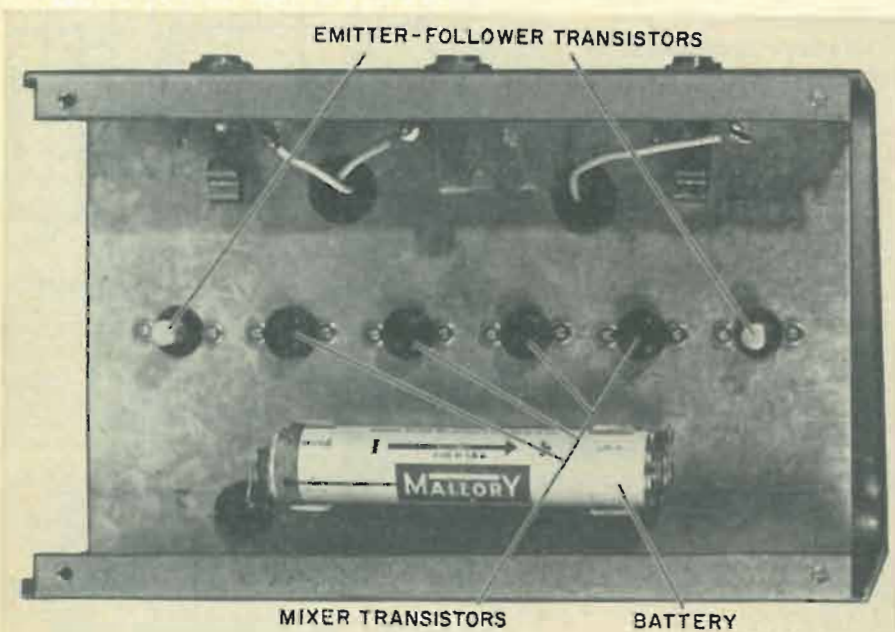

The six transistors (two for the emitter followers, four in the original mixer circuit) are mounted upside-down under the chassis, putting their terminals up close to the wiring.

Transistor Circuits From Scratch

Semiconductors are plentiful and cheap—why not learn to use them?

By OTIS E. VAN HOUTEN

THERE'S NO SUBSTITUTE FOR THE FUN and practical experience you get from designing and building your own amplifier. For many years, it's been fairly easy to design vacuum-tube circuits, for there's lots of literature on the subject. The same isn't true of semiconductors. They're still unfamiliar to many people. This is unfortunate, for it's not difficult to design a transistor circuit. Want proof? Read on.

This method of transistor design that can be mastered by anyone who is able to use the various forms of Ohm's law and also has a transistor-specification manual for determining the characteristics of semiconductors. Two good references are the G-E and RCA manuals available from Allied Radio, 100 N. Western Ave., Chicago, Ill. 60680, and also from most other parts supply houses. Either will provide the required ratings and other specifications.

As for Ohm's law, the design method presented here will require practice in working problems, an approach that will increase your ability to solve equations.

In this method, which I call current-flow design, the equations are calculated to set up predetermined values of current flow in the chosen load and bias resistors. Only three steps are necessary to complete the design: load current selection; load resistor selection; and bias selection, to produce the desired value of load current.

Any RC-coupled class-A transistor amplifier employing the circuit configuration illustrated in Fig. 1 can be designed using the three-step method.

Before you get too deeply involved in the manual, make a list like that shown in Table 1. These factors give you a good idea of where you're heading and indicate the type of transistor to use. The values shown in parentheses may be employed in the design method for any values which cannot be determined from

the available specification sheets. These values will produce a working amplifier from most general-purpose, low-power pnp or npn transistors.

Collector load current in an amplifier stage must fall between two limits. It must be many times higher than the I_{CBO} (collector leakage current)—at least 10 times or more— $I_C = 10 I_{CBO}$ minimum. The current also must be less than the I_C max and less than that value which would exceed the power-dissipation (P_C) rating of the collector—

$$I_C = \frac{P_C}{V_{CC}} \text{ maximum.}$$

To determine the load current required in your amplifier, refer to your table of factors and calculate the values of the two limits. Select a value which lies between these limits. Normally, a current equal to one-half the difference between the two values would be selected. A value near the low limit could be selected for battery-operated devices.

For general-purpose audio-frequency amplifiers in which the upper frequency limit lies below 100 kHz, the value of collector-load resistance should be determined using the previously calculated load current (see above). The collector load resistor should drop approximately one-half the collector supply

voltage (V_{CC}) when the selected collector current (I_C) is flowing. To determine the correct load resistance, compute the value using the formula from Ohm's law,

$$R = \frac{E}{I}. \text{ Therefore, } R_L = \frac{0.5 V_{CC}}{I_C}.$$

Consulting your table of factors, calculate the value of resistance required for your amplifier. Select the stock value nearest to the actual calculated figure. The next lowest value will provide proper operation in almost every case.

For special-purpose amplifiers such as wideband oscilloscope or meter preamplifiers where the highest frequency to be amplified is above 100 kHz, a different selection process must be used to determine R_L .

In high-frequency amplifiers, the load resistance must be reduced to extend the high-frequency response. We accomplish this by reducing the resistance through which the circuit capacitance must charge and discharge. (All transistors have a built-in capacitance between the collector and base and between the collector and emitter. Circuit wiring adds additional capacitance.) In general, the frequency response will be down by 3 dB at the frequency where the reactance of the total shunt capacitance

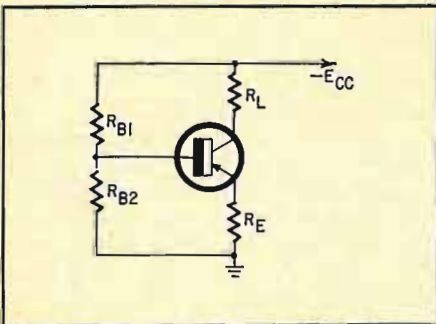

Fig. 1—This is the basic circuit used in the design method described in text.

Table 1—Primary Design Factors

f_2	—	The highest frequency desired to be amplified, in Hz. 20 kHz to 100 kHz for audio and 1 to 2 MHz for oscilloscope preamplifiers. Must be much lower than the cutoff frequency (f_{cb} , or f_t) of the transistor used ($1/10$ or less).
V_{CC} (10 V)	—	The available (or required) power-supply voltage, in volts. Must be lower than the collector-emitter breakdown voltage (BV_{CEO}) of the transistor used.
P_C (100 mW)	—	The power-dissipation rating of the transistor in watts. Use $1/2$ to $1/4$ of the published rating at 25°C if the transistor will be mounted enclosed with heat-producing components.
I_C max (10 mA)	—	The maximum current rating of the transistor in amperes.
I_{CBO} (20 μ A)	—	The leakage current of the transistor in amperes. Use 2 to 4 times the published ratings at 25°C if the transistor will be mounted enclosed with heat-producing components.
C_T (70 pF)	—	The total shunt capacitance across the output in farads. $C_T = C_o + C_i + C_s$, where C_o = output capacitance of the transistor (C_{ob}), C_i = input capacitance of the following circuit, C_s = total stray capacitance of wiring, coupling capacitors, etc.

(C_T) across the output is equal to the value of the load resistor.

In the formula for capacitive reactance (X_c),

$$X_c = \frac{1}{2\pi f C}$$

f = frequency in Hz, C = capacitance in farads, $2\pi = 6.28$.

Substitute R_L for X_c , since they will be equal at the highest frequency the amplifier will amplify satisfactorily. Insert the value of shunt capacitance (C_T) taken from your table of factors along with your desired f_2 , and solve the equation to determine the value of R_L that will produce the desired response.

The resulting formula is

$$R_L = \frac{1}{2\pi f_2 C_T}$$

where R_L is required load resistor in ohms, f_2 is the desired high-frequency response of amplifier in hertz, C_T is total shunt capacitance in farads.

Calculate the value of load resistance required to drop one-half of the V_{CC} as before. Then, for your amplifier, use the smaller of the following two values: the value obtained from the formula just mentioned, or the value as calculated to drop half the V_{CC} as mentioned before.

To illustrate how simple it is to determine the load current and the value of the load resistor to be used, let's look at a typical design problem. A 2N388 germanium npn switching transistor is to be used as an audio preamplifier. Highest required frequency (f_2) is 100 kHz. A 12-volt supply is available.

Step 1—prepare the table of factors

- $f_2 = 100$ kHz
- $V_{CC} = 12$ volts
- $P_c = 150$ mW* at 25°C (50 mW used in calculations)
- $I_c \text{ max} = 200$ mA*
- $I_{CBO} = 10$ μ A* at 15 volts (20 μ A used in calculations)
- $C_T = 70$ pF

Step 2—Determine the required load current

$$10 \times I_{CBO} = 20 \mu\text{A} \times 10 = 0.2 \text{ mA}$$

$$\frac{P_c}{V_{CC}} = \frac{50 \text{ mW}}{12} = 4.16 \text{ mA}$$

*Values from 2N388 data sheet.

One-half the difference is about 2 mA, so this value will be used in the calculations as I_c .

Step 3—Determine the required load resistor

As this is a general-purpose audio amplifier, select the value of R_L so half the collector-supply voltage will be dropped when the design value of load current flows.

$$R_L = \frac{0.5 V_{CC}}{I_c} = \frac{0.5 \times 12}{2 \text{ mA}}$$

= 3,000 ohms. This is a stock 5% value and will be used.

A 2N123 germanium pnp type will be used in an oscilloscope preamplifier. We have a 10-volt collector supply, and the 2N123 must amplify signals as high as 500 kHz. Here's the set of factors:

- $f_2 = 500$ kHz
- $V_{CC} = 10$ volts
- $P_c = 100$ mW (50 mW used)
- $I_c \text{ max} = 125$ mA
- $I_{CBO} = 2$ μ A at 20 volts (4 μ A used)
- $C_T = 70$ pF
- I_c determination: $10 I_{CBO} = .04$ mA
- $\frac{P_c}{V_{CC}} = 5.0$ mA

2.5 mA used as selected current.

In this special-purpose amplifier, the additional calculation for the value of R_L must be employed in addition to the method employed in the basic amplifier:

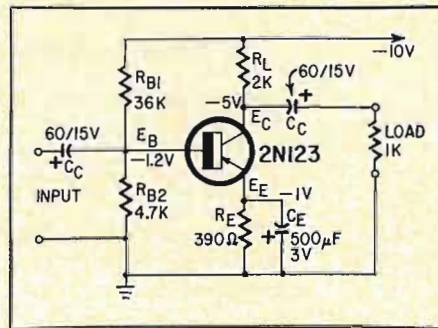

Fig. 2—Example of amplifier design. Component values determined as described in text. Table II gives actual voltages and performance of this circuit.

Table 2—Amplifier Performance

Q	E_c	E_b	E_e	f_{10W}	$f_{h,2h}$	Gain with 1K load
1	5.7	0.91	0.80	<20 Hz	335 kHz	16
2	5.3	1.0	0.88	<20 Hz	335 kHz	20
3	4.8	1.1	0.96	<20 Hz	200 kHz	22

$$R_L = \frac{1}{2\pi f_2 C_T} = \frac{1}{6.28 \times 500 \text{ kHz} \times 70 \text{ pF}} = \frac{1}{.00022} = 4,545 \text{ ohms.}$$

Determining also the value of R_L to drop half of the collector supply voltage;

$$R_L = \frac{0.5 V_{CC}}{I_c} = \frac{0.5 \times 10}{2.5 \text{ mA}} = 2,000 \text{ ohms.}$$

Select the lower value to use in your amplifier. A 2,000-ohm resistor (standard 5% stock item) would be used. Using this value will insure a high-frequency response in excess of the desired value; the lower the value of load resistance, the higher the frequency response of the amplifier.

You now have two examples of the most difficult job in designing an amplifier stage: selecting the collector load resistor and establishing the load current.

A good reference book is a big help in designing amplifiers. Several are available from technical publishing companies and from some parts supply houses. I recommend the *Datadex Transistor Reference Book*, published by M. W. Lads Publishing Co., 46 South 40th St., Philadelphia, Pa. The latest edition of this book will supply the necessary specifications on virtually every transistor produced, and it also can serve as a valuable cross-reference publication.

The final task in designing the amplifier is to obtain the desired load current by choosing the correct bias components. Assume the base current is zero. Actually it isn't, but the base current will be so small in relation to the other currents flowing in the circuit it may be safely ignored.

If the base current is zero, emitter current equals collector current. Therefore, a current equal to I_c flows through the emitter resistor (R_E). To determine the required value of R_E , choose a resistor that will drop 1/10 of the V_{CC} across R_E when collector current (I_c) flows. A value of resistance one-fifth the value of collector resistor R_L will produce this result: $R_E = 1/5 R_L = \frac{2,000}{5}$

= 400 ohms. Select a 390-ohm resistor from the stock list of 5% values.

To determine the value of bias resistors R_{B1} and R_{B2} , assume that a current equal to 1/10 I_c flows through them. The voltage at the junction of R_{B1} and R_{B2} , the base connection, must be equal to 1/10 $V_{CC} + K$. K is the voltage drop across the forward-biased emitter-base junction. K will be very nearly 0.2 volt for germanium and 0.5 volt for silicon transistors.

In the second example given above, the voltage at the junction of R_{B1} and R_{B2} is $1.0 + 0.2 = 1.2$ volts. R_{B1} and R_{B2} form a voltage divider across the V_{CC} supply, and the voltage across R_{B1} must be the remainder of the V_{CC} supply. The voltage across R_{B1} (V_{RB1}) = $V_{CC} - (1/10 V_{CC} + K) = 8.8$. The voltage across R_{B2} (V_{RB2}) = $1/10 V_{CC} + K = 1.2$.

To determine the resistance values required, again use the Ohm's-law relationship $R = \frac{E}{I}$. Current through R_{B1} and R_{B2} is $1/10 I_C = 0.25$ mA.

$$R_{B1} = \frac{V_{RB1}}{1/10 I_C} = \frac{8.8}{0.25 \text{ mA}} = 35,200 \text{ ohms (use 36K)}$$

$$R_{B2} = \frac{V_{RB2}}{1/10 I_C} = \frac{1.2}{0.25 \text{ mA}} = 4,800 \text{ ohms (use 4.7K)}$$

The nearest 5% resistors normally will work very well, and adjustable resistors very seldom will be required to provide bias for amplifiers designed in this manner.

The completed circuit is illustrated in Fig. 2. The voltages noted are the design-calculated values. Actual voltages measured from ground with a 20K ohms/volt vom should be within 20% of these values.

Note that bypass and coupling capacitors are used in this amplifier. Since any practical amplifier must use them, a quickie design method will be given. The value of each capacitor depends on the lowest frequency to be amplified by the amplifier. For most high-quality audio work, even for many special purpose amplifiers, 10 Hz is generally adequate for low-frequency response. A simple formula to determine the capacitance required to provide amplification flat to 10 Hz is

$$C = \frac{160}{R_x \text{ in K ohms}}$$

To determine the required value for the emitter bypass, R_x is taken as R_E ,

$$\text{and } C_E = \frac{160}{R_E} = \frac{160}{0.39} = 410 \mu\text{F.}$$

Referring to the lists of standard capacitance values, use 500 μ F.

To determine the required value of coupling capacitance required, R_x is taken as R_L in series with the input resistance of the following circuit. The input resistance of most junction transistors will be in the vicinity of 1,000 ohms. So, R_x will be $2,000 + 1,000 = 3,000$ ohms, and $C_C = \frac{160}{3} = 54 \mu\text{F.}$ Use 60.

You may use capacitors as low as one-fourth the value calculated above with only a slight effect on the low-fre-

quency response. However, good quality requires the large capacitors.

The voltage rating of the capacitors used should be at least 1½ times the maximum voltage that could appear across them in the circuit. Observe proper polarity when installing electrolytic capacitors and when connecting the collector voltage supply.

Note that transistor gain (H_{fe}) has not been mentioned in this design method. Voltage gain achieved in the circuit will depend upon the transistor gain, of course, but it is not important to produce a working amplifier. Gain will also depend greatly on the nature of the load attached to the amplifier.

Practical example

An actual amplifier stage was constructed using the values of example two. Three 2N123 transistors were selected at random and circuit measurements were made. The results are tabulated in Table 2.

As can be seen in the table, the current-flow design method produces a usable amplifier with predicted specifications. The reduced high-frequency response found in the amplifier constructed from the design of example 2 was expected. The circuit was haywired on a Vector board with lots of stray capacitance. The 500-kHz f_c selected is near the high end of the useful frequency range of the 2N123 transistor when used as an amplifier. 500 kHz was selected purposely to allow an illustration of the design of a special-purpose amplifier.

Transistor design using this very conservative method will produce amplifiers that will perform up to the specifications selected, within the capabilities of the transistor. The circuit will be stable over all temperatures encountered in normal use.

So, there you have it. When considering your next experimental project, why not transistorize it? It's easier than you might think. END

Electronics Culture Corner

BY PHYLLIS BARLOW

REMOTE REPAIR

*You can switch the channel
By remote control today;
It would make me very happy
To fix up sets that way!*

CREDIT HAIKU

*My client wants set
Not tomorrow, now, today;
Will he pay that soon?*

DEAF-INITION

*Some hi-fi fans
It's plain to see
Think VOLUME means
FIDELITY!*

OF ALL GLAD WORDS . . .

*No other words give me a thrill
Like these: "I've come to pay my bill!"*

MESSY SERVICE

*There was a technician named Hopp
Who ran a confused kind of shop;
The sets he acquired
He always miswired;
His income soon took quite a drop.*

PRIORITY RATING

*The night I tried to stay in late
And get my work all up to date,
There was a real emergency;
Dashed home to fix my own TV!*

Getting to Know Low-Cost IC's

From vacuum tubes to transistors was quite a leap. Get ready to jump a little further—into IC's!

By ROBERT F. SCOTT

IT WASN'T MANY MONTHS AGO THAT integrated circuits or IC's were very expensive bits of electronic hardware made by a few manufacturers for use in computers and in sophisticated aerospace, military and industrial equipment. Almost overnight, more manufacturers entered the field, and prices have dropped to the point where many types of IC's are well within the budgets of hams and other electronic hobbyists. Too, some manufacturers have developed lines of low-cost IC's intended especially for consumer items and experimenters and hobbyists.

We are going to take a look at this

field to see what they are and how we can use them in projects. In many catalogs and data sheets, the words used to identify and specify IC's are peculiar to computer and semiconductor technology and you might not be familiar with them. A table and a glossary (page 85) are included to help you find your way around the new world of IC's.

A typical IC consists of transistors, resistors and diodes mounted on or etched into a tiny silicon chip or wafer and connected to perform a specific circuit function or operation. A stage using an IC may have many more transistors and diodes than its equivalent

discrete-component transistor or tube circuit, because the transistors in the IC are used for other purposes. You won't find inductors in IC's—they are impossible to make in reasonable values. Capacitors above 50 pF are rare, as they require so much area on the tiny chip that transistors are used instead, whenever possible. (A number of transistors can be made in less space than one capacitor of conventional value. Too, transistors are the cheapest component to make on an IC, so they are substituted for resistors in many applications. When inductors and large capacitors are needed for circuit operation, they are mounted outside the IC.)

One way to eliminate capacitors—particularly in interstage couplings—is to use direct coupling with an additional transistor for isolating incompatible voltage levels. Fig. 1-a shows coupling capacitor C between two stages of a differential amplifier. Fig. 1-b shows how Q3 replaces the capacitor in a similar integrated circuit. Q1-Q2 and Q4-Q5 are the first and second stages used in RCA's CA3012 wideband IC amplifier.

Thin-film resistors—made by depositing 1-mil layers of tin oxide or similar material on the silicon wafer—are not practical in some circuit applications because their inherent power dissipation rating is too low. Such resistors are often replaced by an MOS field-effect transistor.

In Fig. 2 we have push-pull output stage Q3-Q4 driven by phase inverter Q2. If load resistor R_L is replaced by a MOSFET (Q1) with its gate returned to the negative side of the supply, we then have, in effect, a resistor with a much higher value and dissipation rating than we could get with a thin-film resistor. Too, this transistor occupies far less space than the thin-film resistor it replaces.

Linear IC's

IC's are of two basic types, linear and digital. Linear IC's are generally used for such familiar applications as audio, rf and video amplifiers, sine-wave oscillators, mixers, frequency multipliers, phase detectors, limiters

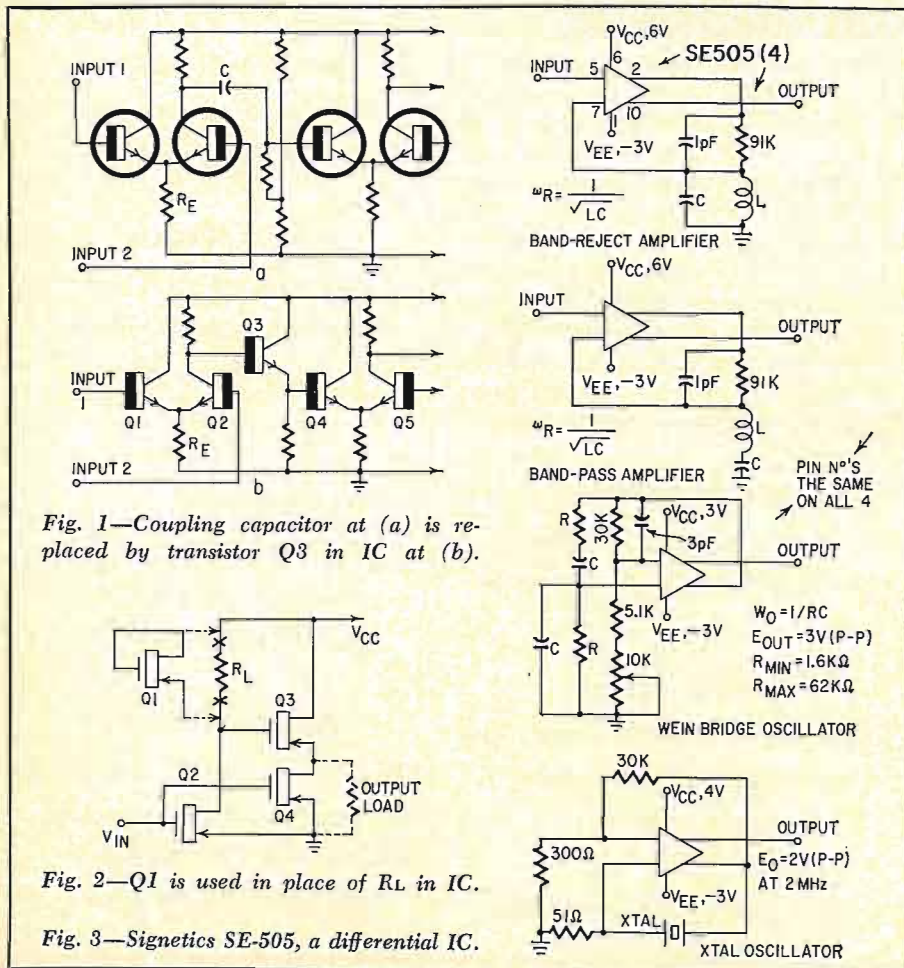

and modulators. The basic linear IC is a direct-coupled amplifier.

The most common linear IC is perhaps the differential amplifier. Its purpose is to deliver an output signal that is linearly proportional to the *difference* between two signals applied to the input. The typical differential amplifier used in IC's consists of two emitter-coupled transistor amplifiers whose emitters are returned to ground through a high-value resistor such as R_E in Fig. 1. Their collectors are connected to a constant-current source. Some have equal resistors in the collec-

tor circuits. In this case, the output signal voltages—taken from the collectors—are equal and 180° out of phase.

If a signal is applied to one input, and the other input is grounded or returned only to its bias source, the stage gain is approximately half that of the differential amplifier. The output signal will appear between the two collectors as usual.

Let's look back at input stage Q1-Q2 of Fig. 1-b. When a single-ended signal is applied to input 1, we have an emitter follower direct-coupled to a common-base amplifier (input 2

must be at ac ground). This gives us a circuit with high input impedance and in-phase (noninverting) input and output signals. Grounding input 1 and applying the signal to input 2, we have the very low input impedance of the common-emitter amplifier and the input and output signals are 180° out of phase (inverting).

The operational amplifier is another common form of linear IC. It is a high-gain direct-coupled circuit whose gain and response can be controlled precisely by external feedback networks. It is designed for use in dc

IC'S YOU CAN AFFORD TO EXPERIMENT WITH

Device	Price	Function	Input	Output	Pkg	Pins	Mfgr
CA3000	\$4.70	Dc amp	Diff	Push-pull	T05	10	RCA
CA3001	6.40	Video amp	Diff	Push-pull	T05	12	RCA
CA3002	4.40	I.f. amp	Diff	Single-ended	T05	10	RCA
CA3004	4.40	Rf amp	Diff	Single-ended	T05	12	RCA
CA3005	2.80	Rf amp	Cascode or diff	Single-ended/PP	T05	12	RCA
CA3006	6.80	Rf amp	Cascode or diff	Single-ended/PP	T05	12	RCA
CA3007	6.00	Af amp	Single-ended or diff	PP emitter foll	T05	12	RCA
CA3008	13.60	Op amp	Diff	Single-ended	Flat	14	RCA
CA3010	12.00	Op amp	Diff	Single-ended	T05	12	RCA
CA3011	2.00	Wide-band i.f. amp	Diff	Single-ended	T05	10	RCA
CA3012	2.25	Wide-band i.f. amp	Diff	Single-ended	T05	10	RCA
CA3013	2.65	I.f. amp-discriminator	Diff	Discriminator	T05	10	RCA
CA3014	3.15	I.f. amp-discriminator	Diff	Discriminator	T05	10	RCA
CA3015	12.00	Low-cost op amp	Diff	Single-ended	T05	12	RCA
CA3016	13.00	Low-cost op amp	Diff	Single-ended	Flat	14	RCA
μ A7703C	4.10	I.f. amp	Diff	Single-ended	T05	6	FA
μ A7709C	15.00	Op amp	Diff	Single-ended	T05	8	FA
μ A7710C	7.50	Diff comparator	Diff	Single-ended	T05	8	FA
μ A7712C	9.60	Wide-band amp	Diff	Single-ended	T05	8	FA
μ L9900	.80	Buffer amp	Computer amp		T05	8	FA
μ L9914	.80	Dual 2-input gate	Computer NAND/ NOR gate		T05	8	FA
μ L9923	1.50	J-K flip-flop	Computer counting and shift register		T05	8	FA
HEP553	4.10	Half adder	Digital binary half adder		T05	10	MO
HEP554	1.69	Bias driver	Voltage regulator		T05	10	MO
HEP556	2.29	3-input OR/NOR gate	Computer logic element and amp		T05	10	MO
HEP558	5.94	J-K flip-flop	Computer storage element and divider		T05	10	MO
WC183T	10.50	Low-level audio amp	Diff	PP Class B	T05	12	WE
WC1146T	10.50	Wide-band amp	Single-ended	Single-ended	T05	8	WE
SE505K	15.00	Small-signal diff amp	Diff	Diff	T05	10	SIG
SE518K	15.00	Analog comparator	Diff	Single-ended	T05	10	SIG
PA7713	10.00	Tuned rf, i.f. amp to 200 MHz, video amp to 60 MHz	Single-ended	Single-ended	T05 & flat	10	PHIL
SN723	17.85	Diff amp	Diff	Diff	T05		TI
SN724	12.15	Op amp	Diff	Single-ended	T05		TI
TFF 3031	4.25	Gated 2-phase flip-flop			T05	8	TRAN
TNG 3231	3.60	Dual 2-input NAND/OR gate			T05	8	TRAN
MIC 945	5.45	R-S or J-K flip-flop			T05	10	ITT

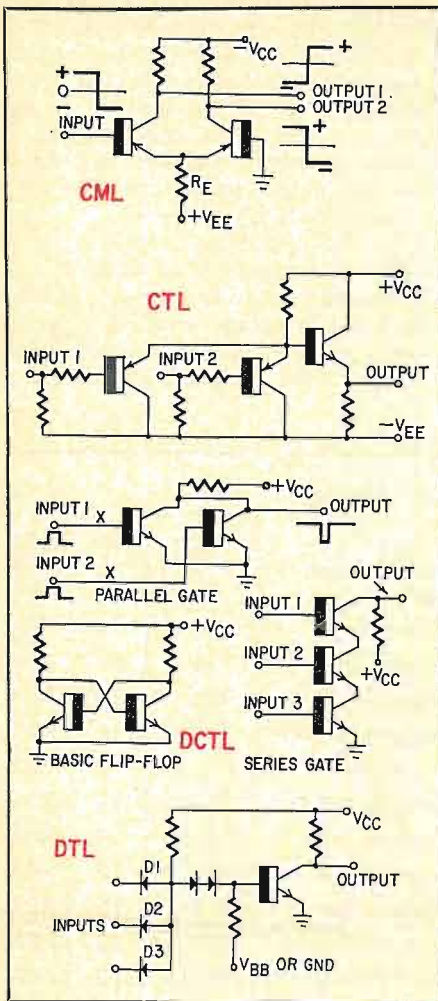

servo systems, analog computers, low-level instrumentation and for generating special linear and nonlinear signals and waveforms. You can use operational amplifiers as tuned a and rf amplifiers and as rejection circuits by using suitable RC networks in the external feedback loop. Fig. 3 shows typical applications of a small-signal differential amplifier—the Signetics SE-505.

Digital IC's

These consist mainly of logic circuits especially useful in computers. They include multivibrators, gates, counters, choppers and shift registers. Experimenters can use them in square-wave generators, signal injectors for radio and TV servicing, bar generators, keyers and tone sources. It shouldn't be too difficult for you to develop an inexpensive linearity or color-bar generator for your lab or workbench, using digital IC's.

There are many digital circuit configurations. The table below and the diagrams show the basic circuit arrangements with pertinent functional information.

The number of linear and digital IC's costing less than \$20 is far too great to detail here. The chart on page 45 lists those that we feel will be most interesting and useful to you. END

Don't miss the glossary of terms used in IC data sheets, on page 85.

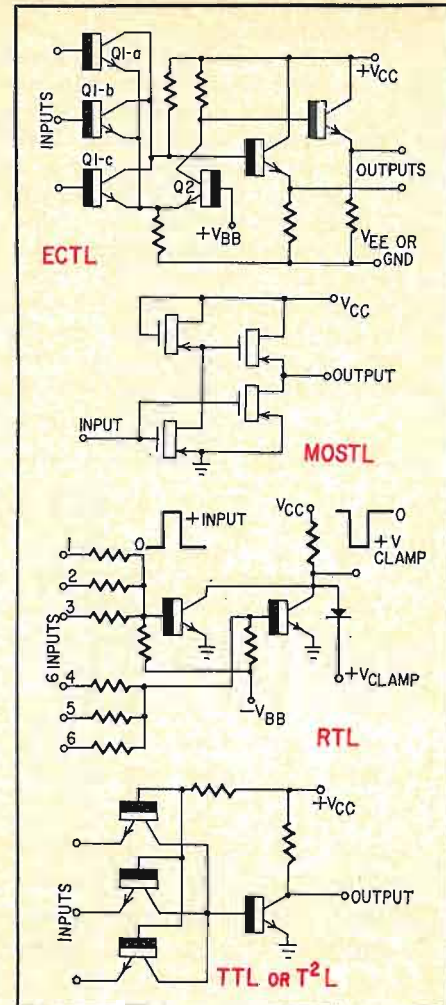

TABLE OF DIGITAL IC'S AND TERMS

CML — Current-mode logic. Generally a split-load differential amplifier with complementary outputs. A circuit design for single-ended output may have $Q2$ omitted and the emitter clamped to ground by a diode. Input and output voltage levels are different, thus making it difficult to cascade stages directly in a logic system. One solution is to use complementary transistors in alternate stages.

CTL — Complementary transistor logic. Has complementary transistors in input and output circuits. The emitter-follower output increases the number of fanouts that can be used.

DCTL — Direct-coupled transistor logic. Transistors in gate, flip-flop and inverter circuits are coupled directly. Diodes, other transistors, resistors and RC combinations are not used as coupling components.

DTL — Diode-transistor logic. Used for NOR/NAND circuits. A NOR circuit for negative-going input and NAND for positive.

ECL — Emitter-coupled logic. See ECTL.

ECLO — Emitter-coupled-logic operation. See ECTL.

ECTL — Emitter-coupled transistor logic. A form of CML operated in the nonsaturated mode. Consists of one or more input transistors connected in parallel as a multiple-input split-load amplifier, emitter-coupled to common-base amplifier $Q2$. The base of $Q2$ is biased positive so it is always conducting while the input or gate transistors ($Q1-a, b, c$) are off. The emitter followers provide voltage-level restoration and increase the number of fanouts that can be used.

LLL — Low-level logic. See DTL.

MECL — Motorola trade name for CML series.

MOSTL — Metal-oxide-semiconductor transistor logic. A logic circuit using MOS devices. Features extremely high input impedance, high transconductance and high fanout capability.

RTL — Resistor-transistor logic.

TCL — Transistor-coupled logic. See TTL.

T²L — Same as TTL.

TTL — Transistor-transistor logic. A low-level logic circuit in which gating diodes $D1, D2$ and $D3$ in the DTL are replaced by transistors $Q1, Q2$ and $Q3$. Requires less operating power and provides faster switching.

VTL — Variable-threshold logic. A form of DTL in which the input threshold voltage can be varied over a wide range.

Crusade Against Car Thieves

By JOHN H. FASAL

EACH YEAR 28,000 CARS ARE STOLEN IN New York City (where I live). Those figures didn't impress me until my car was taken for a joyride. Although the car was recovered with almost no damage, the incident was inconvenient. Recently, however, my newly purchased car was stolen by professional thieves, who stripped it. This outrage made me want to fight back. The alarm described in this article is my weapon against car thieves.

Philosophy of car protection

Complete protection against any and all crime is impossible. There's a weapon to overcome every defense. How can you minimize theft? By making it difficult or impractical to steal the protected object. It's not *impossible* to rob a bank, but it's so difficult that few robbers succeed. The bank, you see, is well protected. Let's examine the steps a thief takes to steal a car, and see how he can be stopped.

- Attack:** The thief tries to enter the car using a master key.
- Defense:** Door switches with normally closed contacts. When a door is opened, the switch opens and triggers an alarm circuit, turning on the car horn. If the thief hastily jumps in and shuts the door, the alarm must remain on. A more sophisticated alarm system may use a motion detector or a photoelectric cell.
- Attack:** The thief tries to silence the alarm.
- Defense:** Hinder access to the battery and horn by locking the engine compartment. This means the intruder will have to lose time and use heavy tools to break the hood.
- Attack:** The thief breaks the hood and disconnects the horn, the battery, or both.
- Defense:** A standby battery, which has been under continuous trickle charge, is automatically switched on. It drives a separate alarm—a bell, a siren or a second horn. This backup

alarm continues for at least 10 or 15 minutes.

- Attack:** The thief becomes increasingly nervous and tries to start the car, despite the alarm.
- Defense:** The ignition system is dead. A hidden switch has bypassed the ignition coil. Most thieves will either quit or be caught by the police at this point.

There are, then, three basic requirements for the auto burglar alarm:

- Make the thief lose time.** He must have to perform difficult and tedious operations to steal the car.
- Make the thief nervous.** His breaking into the car must trigger a loud, persistent alarm which will arouse the suspicion of citizens and police.
- Protect the alarm system itself.** It must be nearly inaccessible and must require more than a few minutes to be discovered. Duplicate vital components and hide them well.

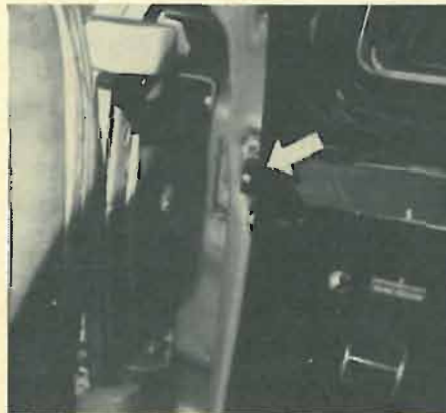

Simplest way to mount door switches is with double-faced tape applied to doorwell.

The typical alarm system contains three basic sections:

- The trigger circuits**—door switches, an ultrasonic motion detector, a PE cell or a body-capacitance circuit.
- The monitoring circuit.** It fires the alarm if the trigger circuit is interrupted (fail-safe circuit). It latches "on" when triggered, and must be reset (turned off) by a hidden switch. This circuit also allows trickle charge of the standby batteries and switches them on when the main battery is disconnected. Of course, a means must be provided to disarm the whole circuit when the owner uses the car. And there must be a way to test the functioning of the system.
- The sounding devices**—horns, sirens, buzzers or bells.

Here is an alarm circuit which meets the above requirements.

The schematic diagram—a simple, efficient and reliable alarm device—is shown below. Normally, the system is powered by the 12-volt car battery. Assuming negative ground, the positive battery terminal is wired directly to terminal 1 of the alarm monitor. (In cars with trunk lights a positive line is available in the trunk.) So long as the alarm is not armed, switch S2 is open. Hence the relay is not energized because relay contacts 2-3 and pushbutton S1 are open.

During such an inactive period (when the car is being driven) the auxiliary battery (a nickel-cadmium type) is continuously trickle-charged. Since the voltage of the car battery is slightly greater than that of the standby battery, current flows from the positive terminal of the car battery through diode D1, series resistor R1, variable resistor R2, diode D2 and the shunted milliammeter. Current then flows through terminal 4 into the standby battery.

Trickle-charge current, which is

- ### PARTS LIST
- R1—20 ohms, 5 watts, adjustable
 - R2—pot. 500 ohms, 2 watts
 - R3—see text
 - D1, D2, D3—silicon diode, at least 150 mA, 100 piv
 - RY—dpdt relay, 12 Vdc (Potter & Brumfield KA-11DY or equivalent)
 - P—pilot lamp, 24V, #1815
 - S1, S1'—pushbutton switches, NO
 - S2, S2'—spst toggle switches
 - S3—spst toggle switch
 - M—milliammeter, 20 or 25 mA full scale (see text)
 - TS1, TS2, TS3—door switches, spst NO micro-switches
 - BATT—battery, 10 volts (8 cells, 1.25 volts each, nickel-cadmium; 220 mA-hr); 8 Eveready B225T cells (or equivalent)

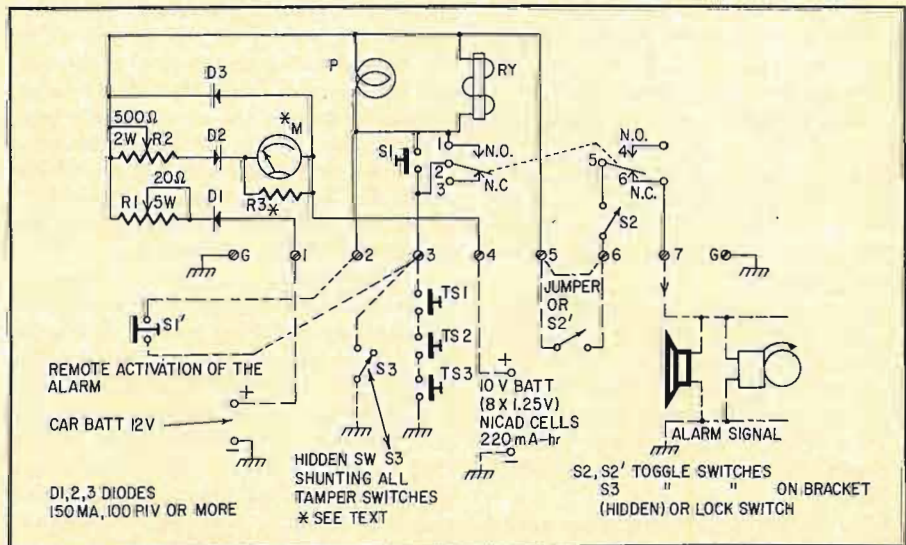

Circuit uses auto battery for primary alarm, but has a backup battery on standby.

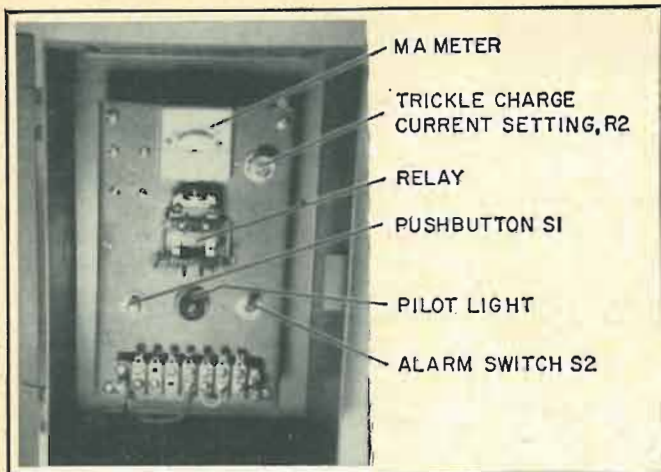

Front panel of the alarm. Meter is used to set trickle charge.

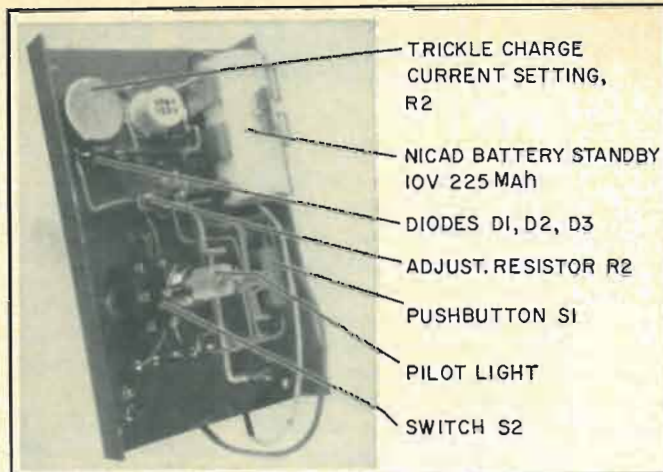

Rear view shows battery mounting and components layout.

critical, is set by variable resistor R2 and is read on the milliammeter. In the model I built, the Nicad battery is composed of 8 button cells, with a capacity of 225 mA-hr and about 10 volts open-circuit, or roughly 1.25 volts per cell. For such a battery the trickle-charge current should not exceed 10 mA. For extended standby action, larger batteries, located outside the control unit, may be used.

You can use a 0–25-mA meter without external shunt R3. If you have a 0–1-mA meter on hand, simply determine the value of R3 by experimentation. Connect a vom on the 50-mA range in series with the 1-mA meter. Try different values of shunt around the 1-mA meter until it reads “10” when the vom reads 10 mA.

If for any reason (such as starting the engine), car-battery voltage drops below that of the standby battery, the Nicad can't discharge back into the car battery. Diode D1 blocks any reverse current. Diode D3 protects the Nicad battery from overcharge. And diode D2 protects the meter from overload. In case of main-battery failure, the standby powers the relay and if necessary the alarm circuit through diode D3.

Here is how to arm the alarm system:

1. Close all windows and doors which are protected by tamper switches TS1, TS2 etc. connected in series. This establishes continuity in the relay circuit.
2. Close pushbutton S1, thereby energizing the relay. The relay latches “on” because contacts 1–2 bypass S1. At the same time contacts 5–6, which control the signal circuit, open. They hold the signal circuit open independent of the position of switch S2.
3. Close switch S2. (Terminals 5 and 6 are supposed to be connected by a jumper.)

Alarm triggering

If one of the door contact switches is opened, the relay drops out and the contacts return to the N.C. position. The latching circuit opens, the signal circuit closes, and the alarm is triggered. Even if the open tamper switch is again closed, the relay remains de-energized because both S1 and the latching circuit remain open.

Disarming the alarm

When the owner wishes to drive his car, he must disarm the alarm circuit. The procedure is very simple; there are only two steps:

1. He interrupts the signal circuit by opening switch S2.
2. He releases the relay by opening a door and getting into the car.

In the preceding example, it was assumed that there is free access to the control box which was located in the trunk. The trunk is protected by a conventional key lock.

A better system would include the trunk in the alarm-protection circuit by installing a tamper switch on the trunk lid. How does the owner disarm the circuit in this case? There must be a hidden switch to bypass the tamper switches. To arm the circuit, all doors and windows are closed and the hidden switch is thrown. To disarm, the hidden switch is thrown and then the trunk may be opened to kill the signal circuit.

The reliability and effectiveness of the whole alarm system depends on the correct location of the hidden switch. A simple spst switch (dotted lines in the diagram) is connected between terminal 3 and ground. The switch should be mounted at a place which cannot be detected easily, and yet a place that's not exposed directly to rain or splash. Moisture may cause a slow but continuous corrosion. One way to prevent this is to use a watertight switch that's protected

by a rubber sleeve. At least one is commercially available and is excellent for outdoor mounting.

Another solution is to mount a magnetic reed switch anywhere inside the car (for instance, on a window behind a sticker). It can be activated by placing a magnet against the window.

Additional security against silencing of the triggered alarm is obtained by hiding the control box with all interconnecting cables in a difficult-to-reach location. In this case it is necessary to provide extensions for switches S1 and S2. The extensions must be well hidden—perhaps inside the trunk. This is illustrated in the diagram in dotted lines (switches S1' and S2'). (S2 remains closed and the jumper between terminals 5 and 6 must be removed.)

The simplest way to obtain an audible alarm signal is by using the car horn. Installation is easy, since the horn contacts behind the steering wheel have only to be bypassed by relay terminals 6 and 7 or the control panel. All connections between 5 and 6 have to be removed in this case. This solution has the disadvantage, however, that silencing is relatively easy and the use of the standby battery to drive the horn becomes impractical.

A better solution is to use a siren, buzzer or bell, or any other device which produces a loud alarm. It must be mounted in an inaccessible place, well protected against rain and dirt. The engine compartment is a good place, but the hood must be locked or provided with a tamper switch. To provide for extended standby action, power consumption of the signal device should be low.

This is but one example of the many possible ways to protect a car from theft. From it, you've learned something about the basics of automotive burglar alarms, and I hope you'll find this system a useful accessory for your car.

END

Twin 200 Watt-Second Solid-State Strobe Slaves

This easy-to-build construction project has 4 light-output settings, direct or slave triggering, and is portable

By E. F. RICE

PHOTOGRAPHY AND ELECTRONICS GO TOGETHER both technically and as hobbies. The new breed of camera may have an electronic shutter, a built-in strobe unit, and various electronic accessories. Professionals and hobbyists in one field often have more than a casual interest in the other. If you often find yourself behind a camera wishing you had a more versatile lighting arrangement, this twin 200-watt-second transistorized slave strobe will be well worth the effort required to build it.

Expense is moderate—well under commercially produced units of comparable power and usefulness—and con-

struction is simple, although dangerous if certain precautions (which we'll explain later) aren't observed. Even if you don't need or want a strobe, you may learn enough from studying the circuitry to feel capable of handling a few strobe repairs you might previously have turned down.

A survey of slave units available commercially quickly showed the lack of several features we wanted, so we had a pretty good idea of how to go about laying out the circuit. Solid-state devices reduce the input-power requirement and give cooler operation and fewer failures. Using a single photocell to trigger both

lamps simultaneously avoids the possibility of "ghost" images due to delayed firing of one lamp.

The trigger unit with its light-sensitive cell is separate from the slaves themselves and can be placed anywhere within the radius of its 20-foot cable. This feature insures that the trigger cell will "see" the firing of the main light, regardless of the position of the slave lamps.

The dual power supply allows you to select four power levels: 200, 150, 100 and 50 watt-seconds. The resulting versatility of light levels gives fine shadow and highlight control.



The complete slave assembly consists of two flash lamps, the remote trigger unit, and the power supply/timer. Cables may be any convenient length, depending on your needs.

This inside view of the power supply and timer shows parts placement. Be certain that the common-return bus does not touch either chassis or cabinet at any point.

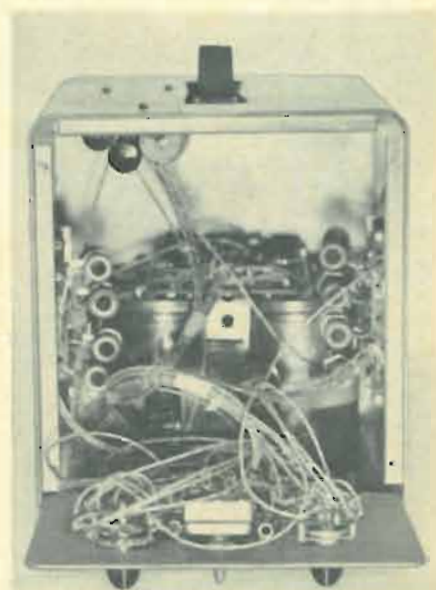

The circuit: a "double doubler"

The schematic diagram shows how full-wave doublers are connected on both sides of the center-tapped secondary of an ordinary receiver-type power transformer. Rectifying and doubling this rms value (340 volts each side of center) charges the capacitors to slightly over 900 volts. Two 860- μ F capacitors in series give a total of 430 μ F, conservatively rated at 900 volts.

A voltage divider—R1, R2, R3 and R4—across half of the secondary allows the ac input to be reduced in four steps. The resistors are 20-watt units with adjustable sliders. With a total capacitance of 430 μ F, the rms voltage required at any tap on the divider is easily calculated using the formula

$$E_{rms} = \frac{\sqrt{\text{watt-sec}}}{41.4} \times 10^3$$

If you want 50 watt-seconds of power, for example,

$$E_{rms} = \frac{\sqrt{50}}{41.4} \times 10^3 = 171 \text{ volts ac}$$

For 200 watt-seconds,

$$E_{rms} = \frac{\sqrt{200}}{41.4} \times 10^3 = 342 \text{ volts ac}$$

The voltage required for 200 watt-seconds is not 4 times the voltage for 50 watt-seconds, because the power increases as the square of the voltage. Identical circuitry is used on both halves of the secondary winding to supply power for each of the twin slave lamps.

Some safety precautions

A little explanation is in order regarding the use of a very high voltage and a relatively small capacitance to get 200 watt-seconds. At first glance, you might think it would be safer to use a lower voltage and put the two capacitors in parallel instead of in series. We tried this and found that the flash tubes, which were designed for a maximum of 250 watt-seconds, do not flash reliably below 500 volts. To obtain the lower powers, we would have to switch capacitors in and out of the circuit as well as change voltages.

Flash tubes designed to operate at lower voltages are available, but these have maximum ratings below the desired 200-watt-second level. Considering all aspects, therefore, the high-voltage approach is the least expensive and most efficient way to get the needed power in four steps.

If not for several safety measures incorporated in this unit, the voltages present would be a serious hazard to the builder. High voltage, of course, is always risky. It's especially so when applied to large capacitors. The instant-

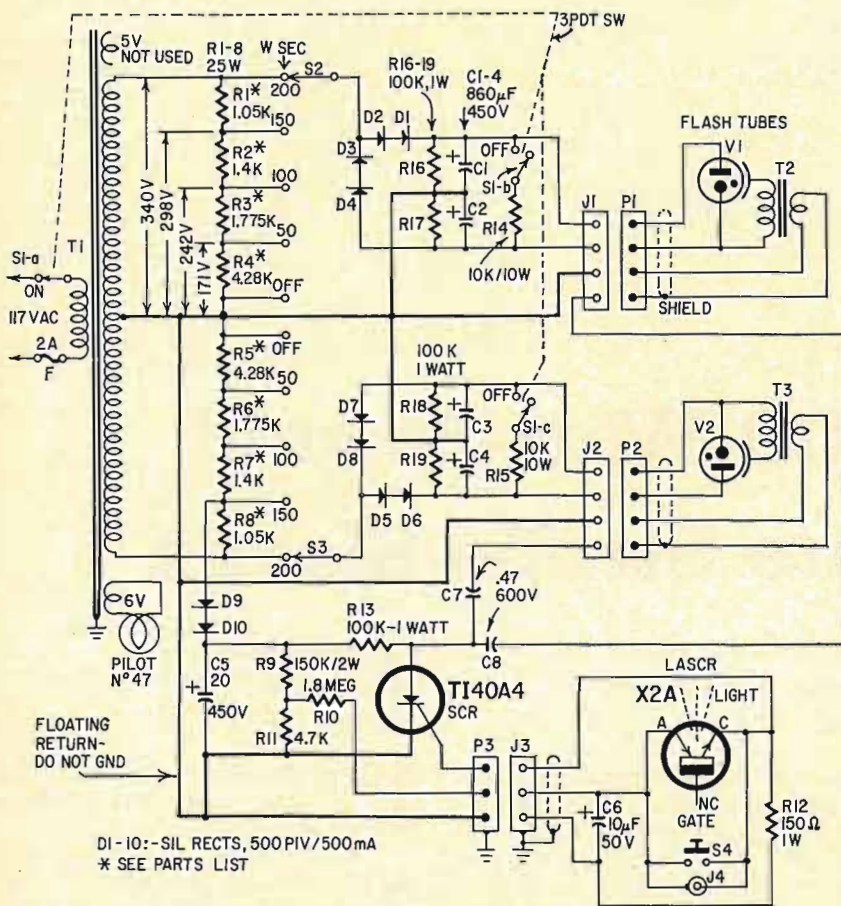

DI-10:—SIL RECTS, 500 PIV/500mA
* SEE PARTS LIST

This is the complete schematic of twin-strobe unit. Be sure that you clip off the LASCR gate lead, don't ground the common bus, and install electrolytics carefully.

PARTS LIST

- R1, R8—1.5K, 25 watts, wirewound, adjustable (set to 1.05K)
- R2, R7—2K, 25 watts, wirewound, adjustable (set to 1.4K)
- R3, R6—2.5K, 25 watts, wirewound, adjustable (set to 1.775K)
- R4, R5—6K, 25 watts, wirewound, adjustable (set to 4.28K)
- R9—150K, 2 watts
- R10—1.8 meg, ½ watt
- R11—4.7K, ½ watt
- R12—150 ohms, 1 watt
- R13, R16, R17, R18, R19—100K, 1 watt
- R14, R15—10K, 10 watts
- S1—3pdt switch (Cutler-Hammer 7613K2 or equivalent)
- S2, S3—5-position rotary switch, 15 amps, 125V ac (Ohmite Power Tap 111-5 or equivalent)
- S4—sps miniature pushbutton, NO (Grayhill 30-1 or equivalent)
- D1, D2, D3, D4, D5, D6, D7, D8, D9, D10—silicon rectifier, 500 mA, 500 piv
- C1, C2, C3, C4—electrolytic, 860 μ F, 450 volts dc (Sprague 861F450DC type 36D, Allied Industrial Electronics 43D5153 or equivalent)
- C5—electrolytic, 20 μ F, 450 volts dc
- C6—electrolytic, 10 μ F, 50 volts dc
- C7, C8—0.47 μ F, 600 volts dc
- T1—power transformer, 117V pri. to center-tapped sec., 340-0-340V (Stancor PC-8408, Newark 1F014, or equivalent)

- T2, T3—flash-tube trigger transformer (Amglow MT-55, Allied Industrial Electronics 60D9387 or equivalent)
- V1, V2—flash tubes (Amglo HD-3—Amglo Corp., 4325 Ravenswood Ave., Chicago, Ill.—or equivalent)
- J1, J2—4-conductor female socket (Amphenol 91MC4F or equivalent)
- J3—3-conductor female socket (Cannon XLR-3-13 or equivalent)
- J4—miniature mike connector (Switchcraft 5501-F or equivalent)
- P1, P2—4-conductor male plug (Amphenol 19MC4M or equivalent)
- P3—3-conductor male plug, Cannon XLR-3-12C
- LASCR—light-activated silicon controlled rectifier (G-E type X2A or equivalent)
- SCR—Texas Instruments type TI-40A4 (or equivalent) with 60-amp surge current and 480 volts forward breakover voltage
- Pilot lamp—#47
- Cabinet—9 x 8½ x 12 inches, Bud Portacab WA-1541 (or equivalent)
- Cable—60 feet of 20 AWG 3-conductor shielded (Belden 8403 or equivalent)
- Miscellaneous—(2) back covers for flash tubes (Amglo R65D—Amglo Corp., 4325 Ravenswood Ave., Chicago, Ill.—or equivalent)
- (2) reflectors for flash tubes (Amglo AR365D, Allied Radio 60A6637 or equivalent)
- (1) small chassis box for remote trigger
- (1) panel-mount pilot-lamp jewel (clear)

neous current available at 900 volts is over 100 amps! If you shorted a screwdriver across the terminals of a charged 860- μ F capacitor there would be a blinding flash, and part of the blade would disappear. Obviously, the damage to a careless builder could range from serious burns and shock to death.

Don't try the "screwdriver test," even out of curiosity. Not only is it tough on your tool supply and dangerous, it also may rupture the dielectric material in the capacitor. And, as you'll soon learn, they don't give away for nothing capacitors of the size required here.

To avoid serious injury, the following safety measures must be followed very carefully:

1. Solder a piece of wire across the capacitor terminals *immediately* on receiving them from the supplier. If you make a careless mistake and apply power prematurely, the fuse will blow, and no voltage will be applied to charge the capacitors. The last step in construction is to remove this short—don't forget.

2. Install the line fuse before any power is applied to the unit.

3. Install the special 3pdt on-off switch and resistors R14 and R15 *before* connecting the capacitors in the circuit. Make certain the switch is wired so that when the 117-volt ac line is *open*, R14 and R15 are *connected across the capacitors*. The switch/resistor combination discharges the capacitors when the unit is turned off. In this way, the charge is gone by the time the front panel is removed for service or testing.

Light-sensing unit

The trigger circuit, shown in the lower part of the schematic, uses a light-activated silicon controlled rectifier (LASCR) instead of a conventional photocell. This simplifies the circuitry and provides excellent light sensitivity. It also produces a strong pulse which is used to gate the main SCR (TI-40A4) that energizes the two trigger transformers simultaneously.

A 298-volt potential, taken from the tap between R7 and R8, is rectified, filtered and reduced by R9 and R10 to about 15 volts dc. This voltage charges C6. When light strikes the LASCR, the device switches from its high-resistance state to a low resistance, discharging C6 through R12. The resulting positive pulse from the top of R12 gates the TI-40A4 into conduction. When C6 discharges, the LASCR turns off again, because R10 limits the supply of current

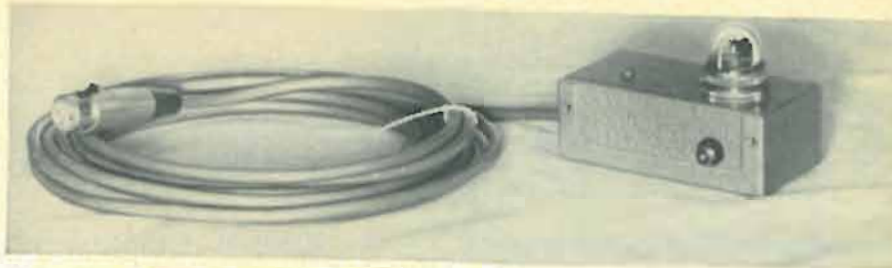

The remote trigger assembly. LASCR is mounted inside the clear pilot-lamp jewel.

from the power supply to a level below the minimum required to keep the silicon junction in a conducting state.

When the TI-40A4 conducts, C7 and C8 discharge rapidly through the trigger-transformer primaries. The sudden current surge through these primaries produces the high-voltage pulses required to flash the Xenon lamps. The TI-40A4 turns off as soon as C7 and C8 are discharged, because R13 limits its current. The capacitors then recharge slowly.

Components for the light-sensing trigger unit are attached to a board mounted in a 4 $\frac{1}{4}$ x 2 x 1 $\frac{1}{2}$ -inch Mini-box. Miniature pushbutton switch S4, mounted on the side of the box and connected across the LASCR, activates the trigger and fires the lamps manually for test purposes. A large pilot-light assembly houses the LASCR. It is mounted by soldering its anode and cathode leads into the base of an old pilot bulb. The gate lead is not used; snip it off. This is done to obtain maximum LASCR sensitivity. A small microphone connector (J3) is mounted on the side of the box opposite S4 and connected in parallel with it. This can be used for attaching a sync cable, if it ever becomes necessary to fire the lamps directly from the camera shutter.

The schematic shows which parts are mounted at the ends of the cables. The main cabinet is a 9 x 8 $\frac{3}{8}$ x 12-inch Bud Portacab. Placement of parts is not critical. The four capacitors are mounted in the back, and the power transformer is located in the center. The doubler diodes are mounted on a board secured to the top of the capacitors. The eight voltage-divider resistors are mounted between pairs of terminal strips running vertically on each side of the cabinet.

Trigger capacitors C7 and C8 are mounted with C5 on a small board fastened to the top of the cabinet. On-off switch S1, along with R14 and R15, is located in the center of the front panel. Power-selector switches S2 and S3 are on either side of the on-off switch. The TI-40A4 and other small parts are soldered to terminal boards on the bottom just in front of the power transformer. No heat sink is needed for the SCR; it is supported on stiff wires soldered to a

terminal board.

Trigger transformers T2 and T3 are mounted inside the back covers of the flash lamps to keep the high-voltage trigger leads as short as possible. Three 20-foot sections of three-conductor shielded cable connect both flash heads and the light-sensing unit to the main cabinet. Cable connections are indicated in the schematic.

Identical plugs are used on the two lamp cables. The cable from the LASCR box has a different type of plug to prevent accidentally plugging it into a socket leading to the high voltage. The two sockets for the lamp plugs are wired so the high voltage is fed to the internal terminals rather than to the external prongs, to reduce the possibility of accidental contact.

The cabinet is *not* connected to the negative side of the power supply. A floating common bus is run throughout the chassis. The box used for the trigger unit is connected to the main cabinet through the shield in the cable. Also, the microphone-type connector mounted on the side of the box is insulated from the box as an added precaution.

Operation is simple

Set the two lamps on stands wherever they are needed, plug in the sensing unit, and attach your regular flash unit to the camera. Select the desired power for each slave light. When you release the shutter, the camera-operated flash unit will actuate the LASCR and the slaves will flash. As noted earlier, you can test the slave units without operating the camera by pressing the button on the side of the sensing unit. Recycle times range from about 5 seconds on full power to slightly over 30 seconds on low power.

If you have trouble getting either or both the flash tubes to fire on the 50-watt-second position, the fault may be that the voltage obtained from this tap is near the minimum for which the tube was designed. Occasionally a tube is slightly less sensitive than normal. To cure the problem, simply increase the 4.28K resistor in the voltage divider (R4 or R5) to about 5K. At the same time, it's a good idea to decrease the 1.775K resistor (R3 or R6) to about 1K.

END

NOMORULE:

A Complete Calculator on a Sheet of Paper

Part 1—Use it wherever you would use a slide rule. Keep your results as long as you like! A portable computer on paper for desk or workbench

By **JOHN H. FASAL***

YOU'VE PROBABLY HAD IT DRUMMED INTO you by now that a slide rule is a tremendous time and labor saver for anyone

*Assistant chief engineer, Alarms Engineering, Walter Kidde Co., Belleville, N. J.

who works with numbers. But do you use one? Whether you do or not, you're in a bit of a bind if you work in several places. You can have several slide rules, or you can carry one with you. The first is expensive, the second a nuisance.

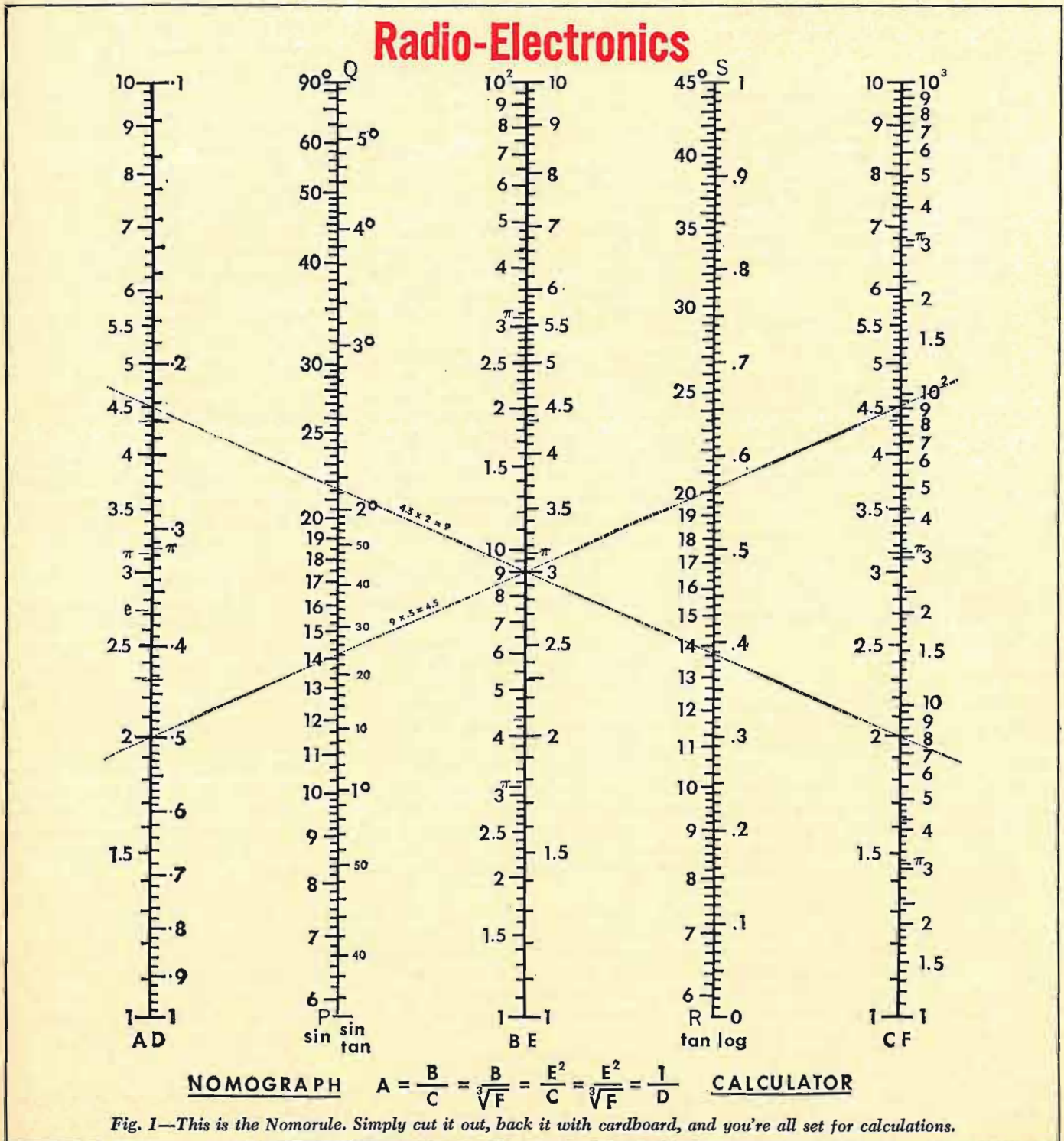

For you, here is a calculator—with a memory, yet—one that you can fold up and put in your pocket, make copies of for all your working places, distribute to your friends, scale up or scale down as you please. Make a few copies right away; when one gets dirty and dog-eared, throw it away and use another. We call it “Nomorule.”

Actually a generalized nomograph calculator, the Nomorule has one big advantage over a slide rule: memory. You can “store” mathematical operations as long as you need them for comparison and checking.

RADIO-ELECTRONICS has set up the Nomorule so you can simply cut it out and use it immediately, just as it is. But to keep it neat and accurate, you’ll want to protect it.

Nomorule (Fig. 1) should be cut from the pages of this magazine and cemented to a hard surface, such as a bakelite board. Cover with a sheet of matte-finish Mylar or acetate (art supply stores), frosted side upward. The Mylar should be held firmly by a spring-loaded clamp fixed to the board. The scales must be well visible through the Mylar, so that you can trace alignments in tiny pencil lines on the frosted surface.

After you complete a problem, just remove the alignment tracings with a damp sponge, or erase with a soft eraser. If you want to keep the solution for further reference, you’ll have to put at least two reference points on the Nomorule and the Mylar cover. Line them up perfectly before starting to “read out” the chart.

Fundamentals

Here are some of the principles on which Nomorule is based.

You can find the product (or quotient) of two numbers, A and B, by adding (or subtracting) their logarithms, like this:

$$\log(AB) = \log A + \log B$$

$$\log(A/B) = \log A - \log B$$

$$\log A^m = m(\log A) = -m(\log \frac{1}{A})$$

$$\log \sqrt[n]{A} = (\log A)/n$$

In a nomogram, we add and subtract logarithmic calibrated scales *geometrically*, rather than by moving a slider within a frame as in a slide rule.

Consider a simple nomograph with vertical scales A, C, B, (Fig. 2). All scales are identical and equally spaced. Let a straight line intersect the scales at P, Q, R. Then the section O_2Q equals one-half the sum of sections O_1P plus O_3R . If the scales are logarithmic we

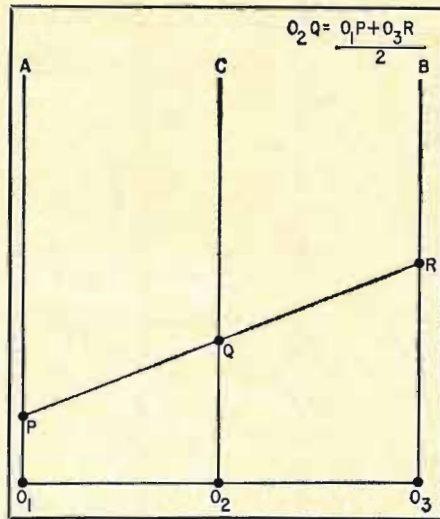

Fig. 2—Principle of the Nomorule: Length O_2Q is arithmetic mean of O_1P and O_3R . Hence O_2Q represents geometric mean.

have the relation, $Q = \sqrt{P \times R}$.

If we are interested in a product only (not its square root) we can change the calibration of middle scale C. We make its *modulus*, or unit length, equal to *one-half* the modulus of the other scales. Then $\log Q = \log P + \log R$, or $Q = P \times R$, directly.

The reciprocal of a number comes easily by using the two sides of the first scale, A and D, in Fig. 1. For example, $D = 0.5 = 1/2$, and $A = 1/D = 2$. The reverse, then, is also true—i.e., $D = 1/A$. Dividing by a number is the same as multiplying by its reciprocal. From $B = AC$, we get $B/A = C$ which then becomes $BD = C$, since $1/A = D$. The dotted line shows that $9 \times 0.5 = 4.5$, or $BD = C$.

Squares and square roots come out of scales B and E, cubes and cube roots from scales C and F. Other relationships,

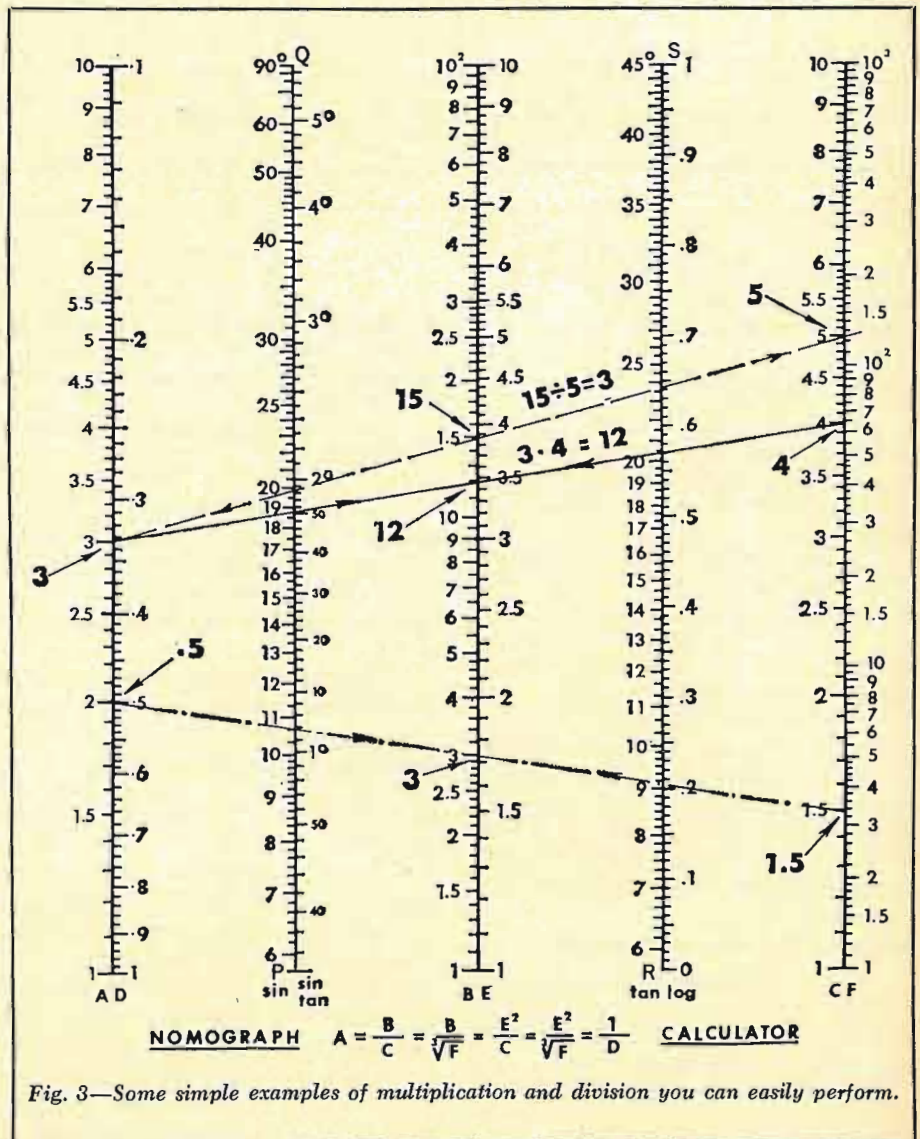

Fig. 3—Some simple examples of multiplication and division you can easily perform.

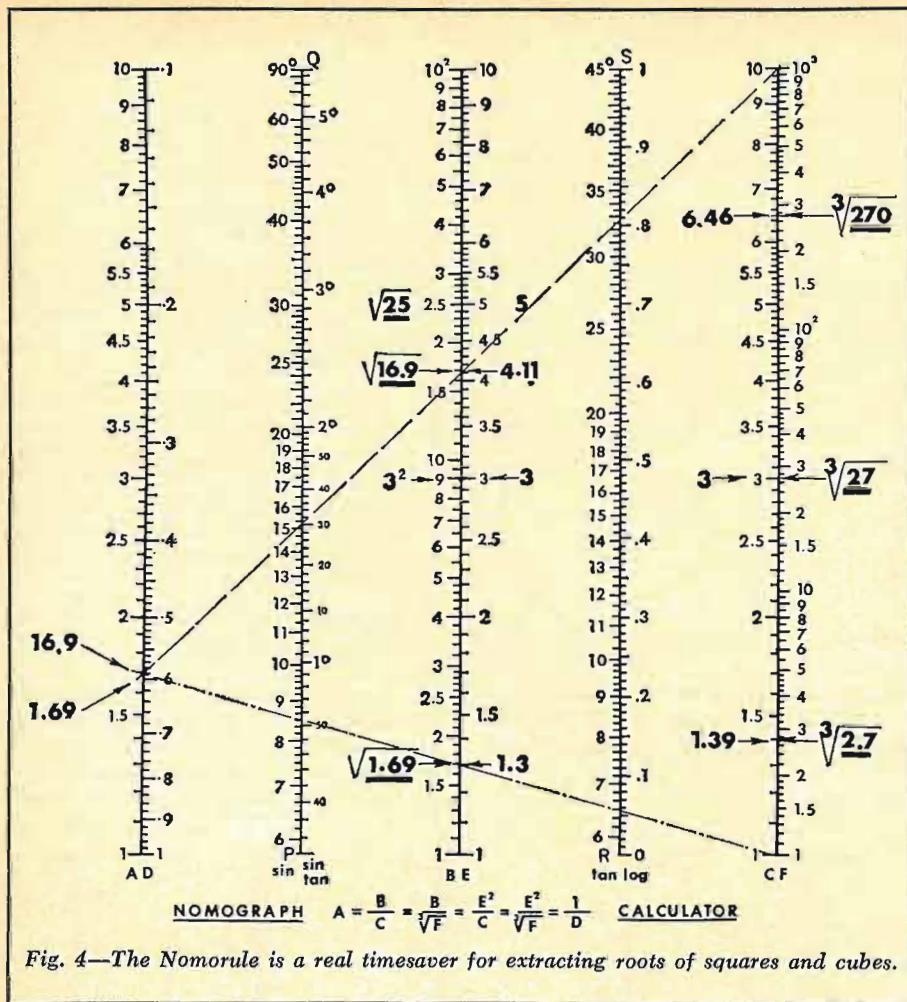

Fig. 4—The Nomorule is a real timesaver for extracting roots of squares and cubes.

including trigonometric and logarithmic functions, can also be read off. We'll come to that in a moment.

Basic operations

Once you know the basic rules, you can handle any combination of operations quickly and easily, and with sufficient accuracy for most practical problems.

Multiplication: Connect 3 (on A) with 4 (on C) to find 12 (on B). This is shown in Fig. 3, solid line.

Division: To find 15/5, intersect 15 (B) with 5 (C) to get 3 (A). This is shown by the dashed line in Fig. 3, and uses the equation $B/C = A$. Note that we chose 1.5 on the higher decade of B, above the 10, so it actually represents 15. Another way to divide is to apply the equation $B = C/D$ mentioned earlier. Intersect 1.5 (C) with 0.5 (D) to obtain 3 (B) shown by the dot-dash line.

Finding the decimal point

Like a slide rule, the Nomorule determines numerical values, not the decimal position. But, as with a slide rule, finding the decimal point is easy.

Numbers can be expressed as some value between 1 and 10, multiplied by some power of 10. For example:

$$13,200 = 1.32 \times 10^4$$

$$.0061 = 6.1 \times 10^{-3}$$

To multiply these numbers, express the product as $1.32 \times 6.1 \times 10^{(4-3)}$. Using the nomorule, we find the answer is $8.05 \times 10 = 80.5$.

To divide 975 by .0003, express the numbers as

$$\frac{9.75 \times 10^3}{3 \times 10^{-4}}$$

and we obtain $3.25 \times 10^9 = 3,250,000$. As before, division of the significant digits is handled by the Nomorule. This result is multiplied by the proper power of 10.

Squares and square roots are read directly from scales B and E. Fig. 4 shows that $\sqrt{25} = 5$, and that $3^2 = 9$. Now let us find $1,200^2$. Write $1.2^2 \times (10^3)^2 = 1.44 \times 10^6 = 1,440,000$. To find $.003^2$, write $3^2 \times (10^{-3})^2 = 9 \times 10^{-6} = .000009$.

Take special care in extracting square roots. To find $\sqrt{169,000}$, first split the number into groups of two digits each, beginning with the decimal point. This points off a number between 1 and 100, whose square root must lie between 1 and 10. Thus, $\sqrt{169,000} = \sqrt{1690|00}$. $= \sqrt{16.9} \times \sqrt{10^4} = 4.11 \times 10^2$. We cannot write 1.69 or 169, multiplied by some power of 10. Likewise $\sqrt{.0169}$ is

written $\sqrt{.0169} = \sqrt{1.69} \times \sqrt{10^{-2}} = 1.3 \times 10^{-1}$.

Squares may also be found by using scales A and E in conjunction with point 1 (C). For example, the dot-dash line (Fig. 4) shows that $\sqrt{1.69}$ (A) = 1.3 (E). The reason? We know that $A = B/C$ and that $B = E^2$. Then $A = E^2/C$. When $C = 1$, $A = E^2$ directly. The same figure shows $4.11^2 = 16.9$, if we use 10 (C) as pole. We have used the equation $A = E^2/10$ in this case, so the answer on A (1.69) must be multiplied by 10 to arrive at the correct solution, 16.9.

C and F determine cubes and cube roots directly. Note that F has three decades, and we must use the correct one. For example, 2.7 is in the first decade, 27 in the second decade, 270 in the upper decade.

For cube roots of large numbers, first split the number into groups of three digits, beginning with the decimal point. For example, $\sqrt[3]{270|000} = \sqrt[3]{270} \times \sqrt[3]{10^3}$; also $\sqrt[3]{.002|700} = \sqrt[3]{2.7} \times \sqrt[3]{10^{-3}}$. Then extract the roots.

Part 2 of this article will continue with scale transfer, trig functions, and other topics.

TO BE CONTINUED

THUNDERBOX PARTS HARD TO FIND?

A number of readers have reported difficulties in obtaining the Delco, Triad and Jensen components specified for the Thunderbox guitar amplifier described in the November issue. You can write to Mr. P. N. Cook, Triad Distributor Div., 305 N. Briant Street, Huntington, Ind. 46750; Mr. Hamlin Welling, Delco Radio Div., General Motors Corp., Kokomo, Ind. 46901; and Mr. Frank D. Lintern, Mgr, Consumer Products Div., Jensen Manufacturing Div., 6601 S. Laramie Ave., Chicago, Ill. 60638 for the name and address of their distributors in your area. Or, you can order from the following mail-order supply houses:

Newark Electronics Corp., 500 N. Pulaski Road, Chicago, Ill. 60624

Triad TY-160X Stock No. 4F450 \$5.47

Triad R-206B Stock No. 4F453 \$10.48

Allied Radio, 100 N. Western Ave., Chicago, Ill. 60680

Triad TY-160X Stock No. 54D 3536 \$5.47

Triad R-206B Stock No. 54 J 3538 \$10.48

Harvey Radio, 2 W. 44th St., New York, N.Y. 10036

Delco transistor DTG-110B \$2.70 ea.

(Specify that both transistors have the same color code.)

Delco heat sink No. 7270725 \$0.90 ea.

1N3209 silicon diode \$1.77 ea.

1N3209R silicon diode \$1.77 ea.

Jensen EM-1250 speaker \$34.62

Plastic Transistors—The Future Billions

The newest type of solid-state package

By KEITH W. BOSE

THE GROWTH OF SOLID-STATE TECHNOLOGY from the early days of germanium to the silicon field-effect transistor has been marked by lulls and spurts of activity. Now there is another surge of action caused by the introduction of a line of low-cost solid-state devices with plastic encapsulation. The use of plastic makes possible a dramatic price drop in transistors, thus opening new areas to electronics. Industry leaders are saying that by 1971 the world will use close to *two billion* plastic-encapsulated semiconductors.

A silicon field-effect transistor with a retail price of only a dollar is something to think about! The availability of such a low-cost device means more electronic applications in the automotive field. Safety devices and driving aids are simpler to manufacture, for instance.

The immediate use for plastic transistors, however, is probably in hi-fi, TV and electronic organs. One amplifier manufacturer reduced his selling price by two-thirds and found that his sales quadrupled. Even the voracious appetite of computers for solid-state devices is being satisfied with the technique of plastic encapsulation.

Plastics engineers climbed a long hill before airtight plastic packages became a reality. After 3 years of experience with the technique, engineer George Berryman of Texas Instruments says that "we have found plastic units as reliable as their counterparts in metal cans."

The plastics involved are derivatives of epoxy, that familiar hardware-

store glue that provides rock-hard bonding between almost any two substances.

The big problem in transistor manufacture was getting a package that could completely seal off air. This sounds easy, but for chemical reasons it's difficult to form a tight bond between plastic and metal. This bond is necessary where the transistor leads enter the case. It is often said that the semiconductor art has two phases—growing the chip, then packaging it so it will operate. Some solid-state manufacturers send chips overseas, there to be packaged in areas of low-cost labor and then return to the U.S.

Plastic-encapsulated semiconductors are manufactured by either of two processes: the liquid or cast-molding system, or the transfer-molding system. The liquid system uses a "header" of ceramic and plastic to hold the leads. This header is formed from powdered glass and ceramic which is first compressed. A charge of ceramic powder follows a charge of glass, followed by a charge of ceramic in a press die. The powder is then compressed until the chemical binder sticks the whole mass together in a solid form.

The presses used for liquid or cast molding are multiple rotary affairs. The forms are "fired" after lead insertion to form a solid mass. The header, together with the leads fused to it and with the chip connected, is covered with liquid plastic, usually in a mold, then baked. The process is messy. Because the resin must be mixed with a hardener just before use, only small batches at a time

are mixed, and proportions are carefully controlled.

Transfer molding is initially more expensive process, but for volume production it offers more advantages. The process uses a dry-mix compound which is transferred to a hot die by heat and pressure. In the process the mixture goes from a solid to a liquid and then back to a solid state. When finished, the chip is surrounded with only one substance—the plastic—and the leads and bonding wires are embedded to form a highly reliable unit.

When a completely new product is developed, some assurance of its reliability must be established. One way to check reliability is simply to sell the product and wait for the customers to scream. This is certainly no way to keep customers or to introduce new products. The safe method is a laboratory test program. Plastic semiconductors have been heated, cooled, pounded, dropped, and given all sorts of rough treatment. Areas of reliability testing are resistance to moisture and the ability to withstand thermal and physical shock. One other consideration is possible damage to the chip by the plastic itself.

Moisture resistance is tested by using what's called a "Joy bomb." A semiconductor is sealed into the "bomb" along with detergent solution. Hydrostatic pressure then forces moisture through any leaks. The new plastics pass this test with flying colors.

Humidity resistance is tested in a "bowser box"—a test chamber in which temperature, humidity and pressure may be precisely controlled. A common ritual for semiconductor testing is 1,000 hours or longer at 90% relative humidity and +45°C.

In many circuits it is important for a transistor to maintain its parameters within certain limits over long periods of operation. The graphs show a "scatter" plot of I_{CBO} and h_{FE} for one transistor after 1,000 hours of back bias at elevated temperatures and high humidity. The 45° lines represent no change from initial readings. Note the close grouping around this line, showing excellent stability. One company—Texas Instruments—has gathered reliability data from 2 million hours of test operation. It appears that plastic semiconductors are here to stay and, what's more important, at low prices.

As an example of the low cost of plastic transistors, the small-quantity retail price of the 2N4419 is in the neighborhood of 50¢. This device is one of a

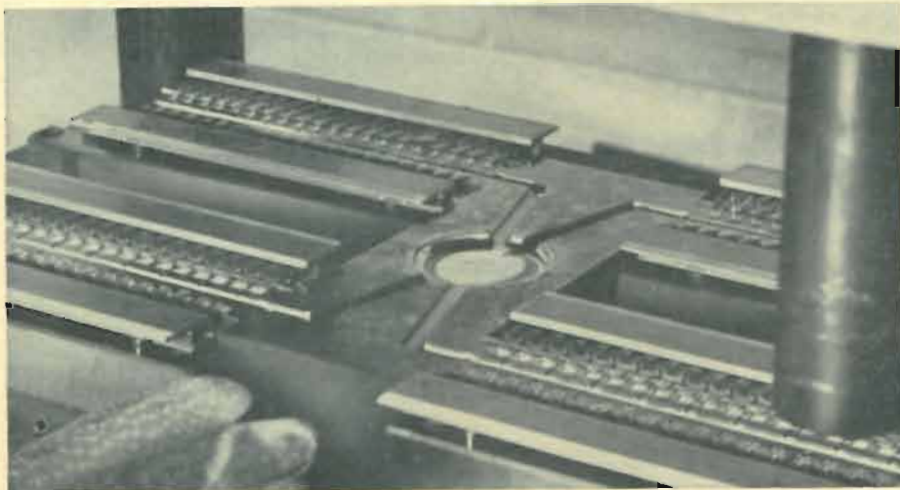

This mold is used for compressing the transistor into a rock-hard plastic capsule.

line of npn/pnp high-speed low-level switches.

Another good example, now available in quantities of 1-99 at \$1.50 each, is the TIP24. Just for comparison, when silicon transistors were first made, around 1960, they sold for \$15 or more.

The TIP24 is a 2-amp epitaxial-planar silicon power transistor. It could be a boon for audio. A pair of TIP24's will easily deliver 20 watts. The devices will sell in pairs matched within 20% ($I_C = 1.5$ amp) assuring minimum distortion in class-B operation. A mounting tab serves as the collector lead of this double-ended low-profile package. This feature allows mounting with only one chassis hole and a sheet-metal screw. In production, it is possible to form the leads and tab for special mounting requirements. Good beta linearity and low saturation voltage is claimed for this transistor, when operated on a 70-volt supply and delivering 10 watts, with 167°F case temperature. With both high voltage and high current, good speaker matching is claimed.

Another low-cost transistor, usable as an oscillator, a multivibrator, a wave-form generator or an SCR trigger, is the TIS43. This one will withstand an acceleration of 60,000 times the force of gravity!

Both silicon and germanium transistors are being encapsulated in plastic. Silicon types are valuable because of their reliability. Their high-temperature characteristics are valuable in places like auto radios and solid-state ignition systems where temperatures soar on hot summer days. Germanium can still turn in the best record for performance, however, and for lowest cost it is still the leader.

Plastic economy packages are

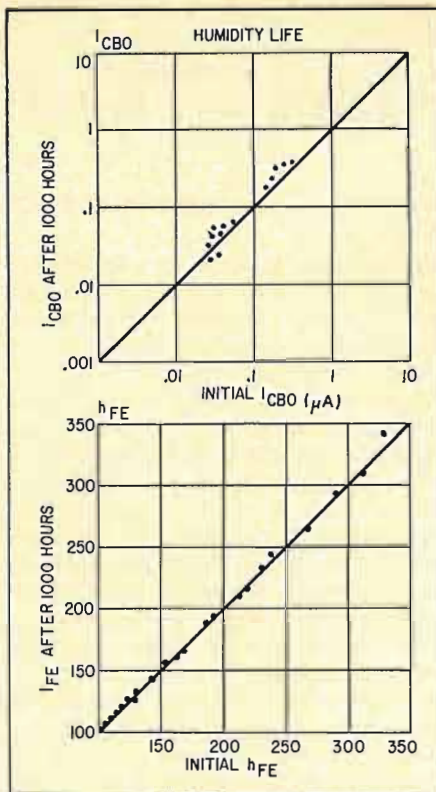

The effect of humidity on I_{CBO} and h_{FE} in a group of plastic transistors. Straight-line before-and-after plots show stability.

available in both silicon and germanium transistors, field-effect transistors, uni-junction transistors, power transistors, silicon rectifiers and integrated circuits. Plastic transistors can be mounted flush on PC boards, reducing the possibility of shorts from excess solder and other production mistakes. One-piece construction leads to increased reliability.

A new plastic IC family of 11 digi-

tal circuits (designated 15830N) includes multiple gates, buffers, expanders, binary elements and a one-shot multivibrator. Plastic encapsulation reduces the price of these circuits 25%. Shock and vibration resistance and heat dissipation of these plastic IC's are excellent. The leads are in two rows, spaced 0.3-inch apart and the units are designed for high-speed automatic insertion in PC boards or chassis.

In production quantities the TIXM-12 costs only \$1. This is a germanium planar field-effect transistor for vhf mixers and amplifiers. It has low cross-modulation distortion, with a noise factor of 2 dB at 10 MHz.

National Electronics, Inc. (a subsidiary of Varian) is now producing a new low-cost readout driver using plastic transistors. Because the price has been reduced, many industrial users will now be able to use readouts on their production lines. Formerly such devices were considered luxuries by many small industrial plants.

Engineers are saying that there are exciting possibilities in low-cost field-effect transistors. The FET has, of course, a number of advantages over both vacuum tubes and junction transistors. It's high impedance makes it useful in many circuits where ordinary low-Z transistors couldn't be used. Furthermore, the output impedances of the source and drain circuits are roughly the same, which is not true of tube plate and cathode circuits.

Plastic encapsulation of FET's increases their reliability and lowers their cost. These are two reasons for predicting that FET's will be used more and more in the next few years. Epoxy capsules seem a major step forward in solid-state technology. END

WHAT'S YOUR EQ?

Conducted by E. D. CLARK

Transistor Current

In the circuit illustrated, forward bias (base-emitter and base-collector)

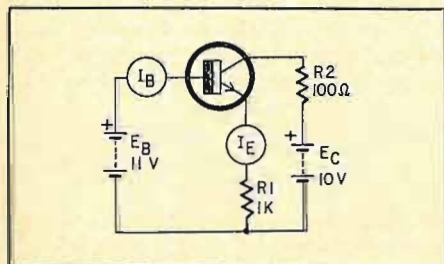

is 0.5 volt. Is I_B (1) greater than I_B , (2) smaller than I_B , or (3) equal to I_B ?
—Allan C. Schoening

Current Mystery

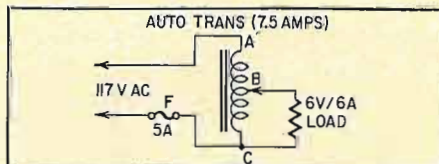

In the above circuit, the fuse does not blow. Why not?—Clarence L. Chinn

Two puzzlers for the student, theoretician and practical man. Simple? Double-check your answers before you say you've solved them. If you have an interesting or unusual puzzle (with an answer) send it to us. We will pay \$10 for each one accepted. We're especially interested in service stinkers or engineering stumbers on actual electronic equipment. We get so many letters we can't answer individual ones, but we'll print the more interesting solutions—ones the original authors never thought of.

Write EQ Editor, Radio-Electronics, 154 West 14th Street, New York, N. Y. 10011.

Answers to puzzles are on page 91.

50 Years Ago

In Gernsback Publications
From March, 1917
Electrical Experimenter

- Using Gas Balloons to Support Wireless Antenna
- A Batteryless Electrolytic Detector by L. Mott-Smith
- Controlling Toys by Radio
- The Quenched Spark Gap by Chas. S. Ballantine
- New Undamped Wave Tuner Has Adjustable Disc Core
- Is Radio Transmission Due to Magnetism? by J. S. Clemens
- Spark Gaps in Running Liquids
- A Rotary Receiver Tuner by Oliver M. Black
- Tri-City Radio Laboratory
- Radio Condenser Hints by Walter D. Scholl

An Experimenter's Transistor Test Set

This easy-to-build and useful tester doubles as a breadboard for experimental circuits

By DONALD R. HICKE*

THOSE WHO WORK WITH TRANSISTORS often need a good transistor test set. If you look through the electronics magazines for the past two or three years you will find several testers described. Some perform simple, go/no-go tests to determine whether the transistor is dead or alive. Others are exotic affairs that could have come only from a professional laboratory and which require an elaborate procedure to test a single transistor. I needed a simple test set for my bench but wasn't satisfied with any of the ones described in published articles.

My biggest objection is that the ordinary tester consists of two batteries and a fixed resistor to supply the base current, and a milliammeter marked in units of *beta* to measure the collector current. Needless to say, this method is not very accurate. More important—it measures the gain of the transistor at only one point. The conditions under which the transistor will actually be used in a circuit may be something else.

I wanted a test set in which the supply voltage and base current could be set to desired values, and the resulting collector current read on a meter. It looked like the only way to get it was to design and build my own. Since it was impractical to include a battery for every supply voltage that might be encountered, I decided that I needed an adjustable, regulated power supply to cover the range of at least 9 through 22½ volts. Of course a meter and some switches were required to get the power-supply voltage to the transistor and to measure the current flowing through it. Then it seemed a shame to confine the power supply to one little test set, so I added binding-post terminals for external base, emitter and collector resistors. The result was a complete general-purpose transistor/diode test set and breadboard.

How it works

Fig. 1-a shows the circuit used to measure leakage current. Shunt resistor R_S reduces the sensitivity of the meter from 100 μA to 10 mA. It protects the meter from damaging currents in case the wrong power-supply polarity is chosen for the type of transistor being tested. Limiting resistor R_L protects the power supply under this same condition by restricting the total amount of current that may be drawn. R_S is removed from the circuit when the PUSH-TO-READ

switch is depressed. If a meter other than the one specified is used, the proper value for the shunt resistor is $R_S = (R_M \times I_M) / (I_T - I_M)$, where R_M is the meter resistance, I_T is 10 mA and I_M is 100 μA . This simplifies to $R_S = .0101 R_M$. In other words, when you buy your meter to build this test set, simply multiply its resistance by .0101 to get the value of R_S . You will probably have to parallel two resistors to get the exact value.

Base current is applied and measured with the circuit shown in Fig. 1-b. The 2-meg pot in series with the base-emitter junction of the transistor is adjusted to obtain the desired base current. The PUSH-TO-READ switch must be depressed to remove the meter shunt when

taking a reading. Unlike most other test sets of this type, no interpretations or approximations are necessary because the meter shows the base current directly in μA .

Collector current is measured by switching to the circuit of Fig. 1-c. This method has an advantage compared to others which have been previously published. Resistor R_M , equal in value to the internal resistance of the meter, is switched into the base circuit when the meter itself is switched out. This eliminates errors which would otherwise result from the change of resistance in the bias circuit. In addition the shunt is arranged so that the meter circuit is opened in case the PUSH-TO-READ switch is inadvertently depressed. This prevents



The black tape lines on front panel make it easy to connect semiconductors for test.

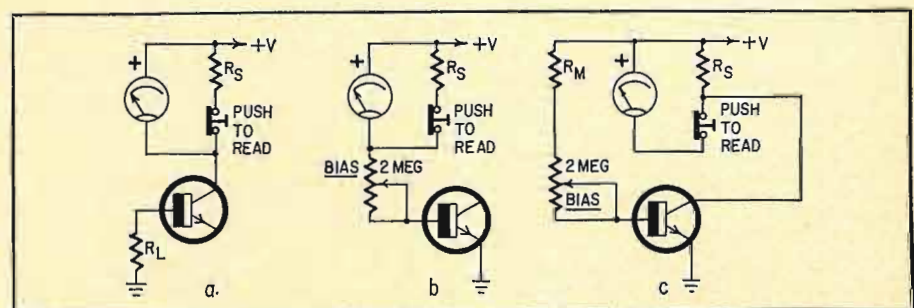
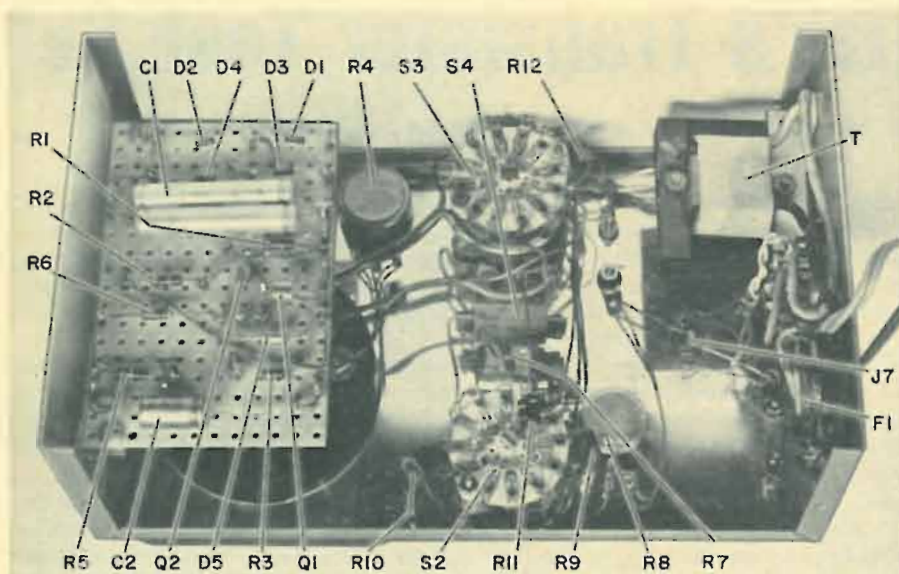

Fig. 1—Three basic circuits: a—leakage, b—base, and c—collector current measurement.

*Brown Engineering Co., Huntsville, Ala.



Parts placement. Punched board is mounted on side of chassis just above meter.

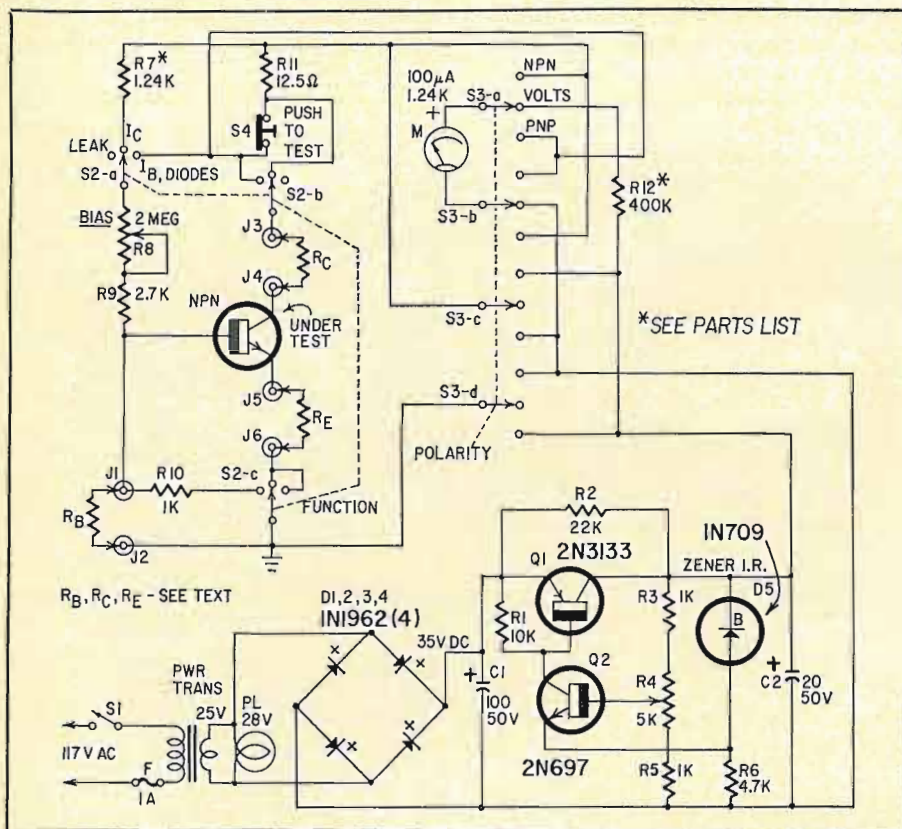

Fig. 2—Wiring diagram shows use of regulated power supply to stabilize measurements.

- R1—10K, ½ watt
- R2—22K, ½ watt
- R3, R5, R10—1K, ½ watt
- R4—pot, 5K
- R6—4.7K, ½ watt
- R7—1,240 ohms, ½ watt, 1% (Aerovox CEC T-0 or equivalent)
- R8—pot, 2 megs
- R9—2.7K, ½ watt
- R11—12.5 ohms, ½ watt, 1% (Aerovox CPSX½ or equivalent)
- R12—400K, ½ watt, 1% (Aerovox CPSX½ or equivalent)
- C1—100 µF, 50 volts, electrolytic
- C2—20 µF, 50 volts, electrolytic
- D1, D2, D3, D4—100 volts, 600 mA (G-E 1N1962)
- D5—Zener, 6.2 volts, 400 mW, 1N709 or equivalent
- Q1—pnp (Motorola 2N3133 or equivalent)
- Q2—nnp (G-E 2N697 or equivalent)

- T1—filament transformer, 25 volts, 1 amp (Knight 54A1421 or equivalent)
- M—100-µA 1,240-ohm meter (Knight 52A7202 or equivalent)
- S1—spsl slide switch (Continental Wirt G323 or equivalent)
- S2—3-pole 3-position rotary switch (Centralab 1007 or equivalent)
- S3—4-pole 3-position rotary switch (Centralab 1013 or equivalent)
- S4—normally closed pushbutton switch (Grayhill 4002 or equivalent)
- PL—28-volt lamp
- F1—1-amp fuse
- J1, J3, J5—red 5-way binding posts
- J2, J4, J6—black 5-way binding posts
- J7—transistor socket (Elco 05-3301 or equivalent)
- Miscellaneous: Lamp socket, fuse holder, 10 x 6 x 3½-in. cabinet, handle.

any possibility of burning out the sensitive meter through improper operation of the test-set controls.

The schematic of the test set is shown in Fig. 2. The power supply is relatively standard. It uses an inexpensive 25-volt filament transformer and a full-wave bridge rectifier to supply dc to the regulator. The output across R6 is always 6 volts less than the regulator output because of the constant drop across Zener diode D5.

The base-emitter current in Q2 therefore depends upon the power-supply output voltage and the setting of pot R4. This current is amplified and taken through transistor Q1, which is the series regulating element, to hold the output constant with variations in load. The output can be varied from 7 to 33 volts, and regulates up to 10 mA over the range of 8 to 30 volts. If the output is accidentally shorted (from experience, I'd say this happens pretty often), Q2 sees zero volts at both its base and emitter. It ceases to conduct, which cuts off Q1 and no harm is done. Resistor R2 is needed to restore the power supply to operation after the short is removed. Capacitor C2 must be relatively small, say 20 µF or so, so that it cannot supply large currents when shorted.

Transistors other than the ones listed may be used, provided certain conditions are met: Q1 must be rated at least 40 volts collector-to-base (V_{CBO} on most data sheets) and 600 mW dissipation (P_D). Suitable devices include the Motorola 2N1132 and 2N3133 silicon transistors, or the RCA 2N1183 germanium transistor which costs a lot less but is larger in size. Transistor Q2 may be almost any small-signal type with a collector-to-emitter (V_{CEO}) rating of 40 volts.

The power-supply output voltage is monitored on a 0-40-volt scale on the meter by connecting resistor R12 in series with it. A value of 400,000 ohms is correct for almost any meter you might use, because the meter's resistance will be small in comparison.

Comparing Fig. 2 to the simplified circuits in Fig. 1, note the following: R7 is meter-substitution resistor R_M ; R10 is current-limiting resistor R_I , and R11 is meter-shunt resistor R_S . The resistors labeled R_N , R_P and R_C are connected externally as needed. Also note that, because of the reversal of power-supply polarity when changing from an npn to a pnp, both sides of the power supply must float above ground. This means that all capacitor and semiconductor leads must be insulated from the chassis.

Construction

The size of the test set is determined mainly by two things: the size of the meter used and the space required for the circuits connecting the test

terminals. I used a 6 x 10 x 3½-inch metal cabinet and had no trouble fitting everything inside.

The power-supply regulator is wired on a piece of punched circuit board which fastens to one side of the cabinet with small brackets. The transformer and fuse are on the other side. All other components are mounted on the front panel.

The binding-post terminals and the transistor socket are arranged in the form of a common-emitter amplifier circuit and symbolically connected with narrow strips of black tape to simulate the internal connections.

The original meter scale is erased and two new scales added with India ink to read 0–40 for voltage and 0–100 for current. You have to divide by 10 mentally to read collector current to 10 mA, but this is no problem.

The test set shown in the photographs was admittedly built mostly with junkbox parts, especially the meter, rotary switches and power transformer. The components recommended in the parts list, however, are electrically equivalent and in most cases superior to what I used.

Operation

Using the test set is as simple as 1, 2, 3. In fact, there are only three steps:

1. Check leakage.
2. Set base-bias current.
3. Read collector current.

To check leakage, first connect a jumper across the R_C terminals and set the function switch to the LEAK position. Then turn the polarity switch to NPN or PNP as appropriate and depress S4, the PUSH-TO-READ switch. Read the collector-to-base leakage current directly on the 0–100- μ A scale. When performing this test be careful not to exceed the BV_{CBO} rating of the transistor that's being tested.

To set base-bias current, complete the emitter circuit by connecting a jumper across the R_E terminals. Turn the function switch to the I_B position and depress S4. Adjust the bias pot until you read the desired base current on the 0–100- μ A scale of the meter.

To read collector current, make sure that both the R_C and R_B terminals are jumpered and then turn the function switch to the I_C position. Read collector current in mA by dividing the 0-to-100 scale reading by 10.

Applications

This transistor test set has several useful applications. One of the most obvious is to determine the polarity of an unmarked or unfamiliar transistor. To do this, plug the orphan into the test set and measure leakage. If the meter shows almost full-scale deflection, the transistor is either shorted or is the opposite

polarity from that assumed. To tell which, simply turn the polarity switch to the other direction and watch the meter. If it still shows full scale, the transistor is shorted. It should be necessary to depress S4 to get a reading when the correct polarity is chosen. In other words, a full-scale leakage reading means that the collector–base junction is forward-biased or shorted.

Another important application of the test set is to determine how much base-bias current is needed to get a certain amount of collector current. Let's say you are building a circuit where you want 1 mA to flow in the transistor. Set up the test set to read collector current and adjust the bias pot until the meter indicates 1 mA. Then turn the function switch to the I_B position, depress the PUSH-TO-READ switch and read the required bias current directly on the meter. To determine the bias resistance under these conditions, turn the function switch back to I_C , the polarity switch to VOLTS, and remove the transistor from the socket. Then use an ohmmeter to measure the total resistance of R7, R8 and R9 between the J1 and J3 terminals (just follow the taped lines; that's what they were put there for).

The test set may also be used to check Zener diodes. Connect the diode and a voltmeter to the R_B terminals, following the decal for polarity. Set the voltage and bias controls to minimum, the function switch to DIODES (same position as I_B), and the polarity switch to NPN. Slowly increase the bias and then the voltage while watching the meters. The point at which the voltage ceases

to increase is the Zener voltage of the diode, and the current reading at that point (don't touch S4) is the minimum Zener current. Continue to increase the voltage to see how well the diode regulates over a range of current.

The forward voltage drop of a regular diode can be checked in much the same way. Connect the diode backward—with the arrow pointing down—and set the bias control for the desired forward current (again, don't touch S4). Read the voltage drop on the voltmeter.

By far the most useful application of this test set, however, is as a breadboard for checking experimental amplifier circuits. Assume that you'd like to make the simple audio amplifier shown in Fig. 3-a from page 276 of the General Electric *Transistor Manual*, seventh edition. Suppose you have an npn 2N508 instead of the pnp 2N508-A called for. Assume that supply voltage is 20 instead of 27. Simply adjust the test-set power supply to 20 volts; connect the base, emitter and collector resistors to the test terminals and plug in the transistor. Connect a signal generator to the base at terminal J1 and a scope to the collector at J3. Set the function switch to I_C and the polarity switch to NPN. Turn on the signal generator and adjust the bias pot for symmetrical clipping of the output-voltage waveform. Read the value of the needed bias resistor with an ohmmeter, as explained above.

In the example shown in Fig. 3-b, symmetrical clipping was obtained with the bias resistance set at 175K, which resulted in 12 volts at the collector. The output was 15 volts peak-to-peak with 3 volts input. The ac voltage gain is markedly improved by adding a bypass capacitor across R_E . Of course the optimum dc bias point and the maximum undistorted ac output voltage remain the same.

Improvements

Several refinements of this test set can extend its usefulness. The addition of a 1-kHz oscillator would simplify ac voltage-gain measurements. I didn't attempt this in the original model because I have access to an external signal generator.

Another improvement would be to add a second transistor test socket with the corresponding resistor jacks and internal connections to the meter. This would allow the popular two-transistor preamplifier circuits to be breadboarded with ease.

Finally, a second current range of, say, 40 mA would be very useful for checking many transistors and diodes. It would, however, require changes to the power supply and, as a suggestion, an extra position on the function switch called HIGH I_C , or something to that effect.

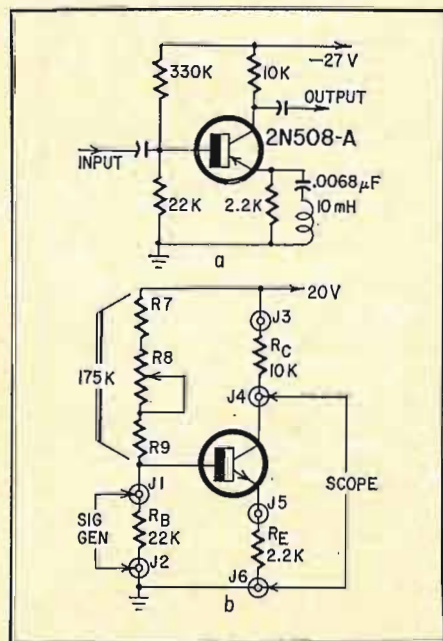

Fig. 3—How to use the test set to breadboard an amplifier. a—Original recommended circuit. b—Modified practical circuit found by experiments with tester.

Walkie-Talkie Power Booster

Build this outboard linear amp, which can be used with any 100-mW transceiver, and increases transmitting power and range of your rig

By ARTHUR T. CRANE, KHA9543

HAVE YOU BEEN ADMIRING THE RASH of high-powered 1-watt walkie-talkies that have hit the market? Ever thought to yourself, "If only my 100-milliwatt had more power?"

Build this compact piggyback linear amplifier and realize your desire. This transistorized attachment will boost the output power of any 100-mW walkie-talkie by a factor of 25. And 2 watts of undistorted squawk-power is obtained with only one transistor. The cost of parts is less than \$30—far less than the cost of a new 1-watt. You also get the bonus of a built-in battery recharger. Many commercial units feature this only as an optional, extra-cost accessory.

Three watts PEP (peak envelope power) is approximately 2 watts average rf output. Look at what 2 watts will do for your transmitting range. A 100-mW transceiver has about 80 mW rf output. With 85% modulation and a good hot receiver such a rig will pro-

vide communication up to 2 miles under favorable conditions. The rule of thumb is this: The transmitting range increases as the square root of the output power. Clip on the linear and your output power increases 25 times. The square root



Strap linear to transceiver back so both push-to-talk switches are on the same side.

of 25 is 5. That means five times greater range, or about two-thirds the range of a mobile CB unit running the legal limit of 4 watts rf output (5 watts dc input).

This amplifier simply clips onto your walkie-talkie. No butchering is necessary. You can still use 100 mW for close-range communication. For greater range, switch over to 2 watts of power. However, don't forget to use your proper CB call sign and legal operating procedures—whether you run high power or low—or you invite an FCC citation. If you don't have a CB license at present, you must get one.

Linear amplification must be used on any signal that carries modulation. This eliminates spurious output (splatter) near the operating channel. This amplifier operates class-B linear, in preference to class A, because of the higher efficiencies possible. The class-A linear can theoretically be only 50% efficient. Class-B linear can theoretically approach 78.8% efficiency.

The 80-mW exciter signal enters the linear through C3 (see Fig. 1). This capacitor must be mounted on the alligator clip at the end of the coax. The purpose of C3 is to match the 50-ohm coax to the walkie-talkie output stage. The base circuit of Q1 is tuned by the parallel network L1—C1. C2 determines the level of rf drive applied to the base. The collector output circuit is somewhat unconventional, but loads well. The short 55-inch whip presents a highly capacitive reactance to the collector circuit. This is tuned out by L2. Collector tuning is accomplished by C4; antenna loading by C5.

The battery recharging circuit economically extends battery life. While zinc-carbon and manganese-alkaline batteries cannot actually be recharged (they are dry cells), they can be "rejuvenated" somewhat—if they are caught before they run down too far. Manganese-alkaline cells can be rejuvenated more times than the ordinary zinc-carbon variety. A rejuvenated battery will deliver about one-half the energy per charge of a new one. Thus an overnight recharge can bounce the batteries back for more service dozens of times. A word of caution, however: start with a fresh set of batteries. Old batteries that have deteriorated through chemical action cannot be satisfactorily rejuvenated.

Constant-current charging is employed. Diodes D1 through D4 constitute a full-wave bridge rectifier circuit. The 60-Hz reactance of C10 limits the charging current to 35 mA. Diode D5 blocks the collector supply from discharging through bias network R1 and R2. C6 and C9 isolate the chassis from the charging circuit. Since one side of the rectifier bridge is common with the line, C6 and C9 eliminate a potential shock hazard. No attempt is made to

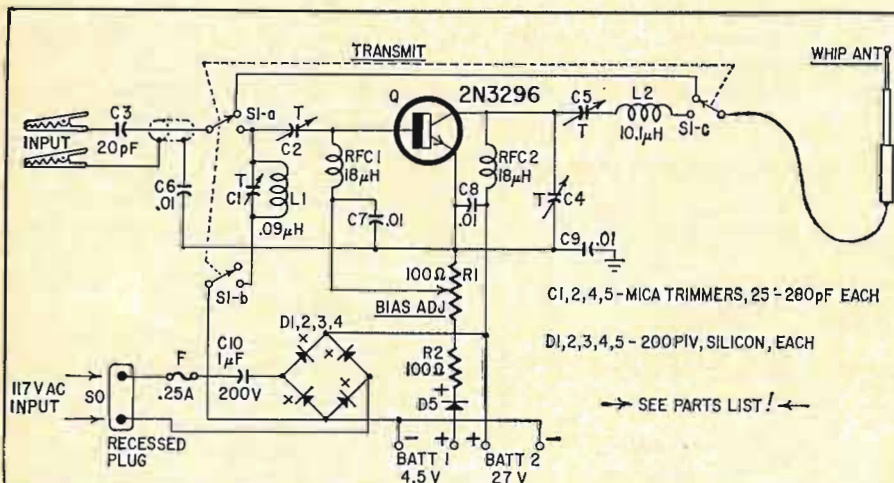

Fig. 1—Complete schematic of the linear amplifier. Ac plug is TV chassis type.

Parts List

- C1, C2, C4, C5—mica trimmer, 25–280 pF, (Arco-Elmenco 64 or equivalent)
- C3—20 pF mica
- C6, C7, C8, C9—.01 μ F disc ceramic
- C10—1 μ F, 200 volts, Mylar
- D1, D2, D3, D4, D5—200 piv silicon
- F— $\frac{1}{4}$ amp fuse
- L1—.09 μ H coil consisting of 4 turns of #18 wire on a form $\frac{3}{8}$ inch long and $\frac{1}{4}$ inch in diameter
- L2—10.1 μ H coil consisting of 30 turns of #18 wire on a form 1 $\frac{5}{16}$ inches long and $\frac{1}{4}$ inch in diameter
- Q1—Motorola 2N3296 or equivalent
- R1—linear pot, 100 ohms, $\frac{1}{2}$ watt, (Bourns 3067-S or equivalent)

- R2—100 ohms, $\frac{1}{2}$ watt
- RFC1, RFC2—18 μ H, (J. W. Miller 9310-42 or equivalent)
- S0—repressed plug, (Cinch-Jones 2RP or equivalent)
- S1—3pdt pushbutton type, (Switchcraft FF-1009 or equivalent modified as described in text)
- ANT—55-inch replacement whip for walkie-talkie, (Dunell A-2 or equivalent)
- Miscellaneous: Case, $5\frac{1}{4}$ x 3 x $1\frac{1}{2}$ inches, (LMB 531 EL or equivalent); 10 inches of RG-58/U; 2 alligator clips; 1 5-point terminal board; 1 2-point terminal board; TV-type ac cheater cord; nuts and bolts; 21 manganese-alkaline cells, (Eveready E92 or equivalent).

recharge the three bias cells, since they will outlive the rejuvenated collector-supply batteries anyway.

Construction is simple and straightforward. A standard metal utility box is used as the housing to give the finished unit a professional appearance with a minimum of effort. First, lay out and drill all the holes in the housing, following Fig. 2. Next, fabricate the battery box from .030-inch sheet aluminum. Fig. 3 is the pattern.

Push-to-talk switch S1 must be disassembled and modified to conserve space. Take the switch stack completely apart. Reassemble it as shown in the photo. The bottom section (S1-b) should be reassembled as it was, with one exception: Remove the normally closed (N.C.) blade. The next deck supports both S1-a and S1-c and each blade is supported by only one mounting hole. The overhanging unused "hole" should be clipped off with diagonal cutters. Shape the fiber blade actuators slightly with a file and mount them in Y-fashion, as shown. It will, of course, be necessary to trim off the cylindrical plastic screw insulators and switchstack mounting screws to complete the modification properly.

Install the rubber grommets, and assemble all the bolt-together hardware. Don't install the antenna until after the wiring is completed. Insulate the battery compartment by lining it with electrical tape.

Proceed with the wiring, being careful to avoid getting the transistor and diodes too hot. The input and output coils (L1 and L2) should be mounted so they're off the chassis and at right angles to each other, minimizing feedback. All rf component leads should be kept as short as possible. Install the antenna and you've completed the amplifier and charger wiring.

Special care must be exercised in assembling the rechargeable battery pack. The batteries are soldered together to conserve space and reduce cost, even though battery makers don't recommend soldered connections to their batteries.

The center electrode of a manganese-alkaline cell (minus post) is the most difficult to solder to. Excessive heat softens the plastic seal, and at the same time generates steam within the cell, destroying the seal. The cell will then short itself out, and may possibly rupture from internal pressure buildup. Such ruptures are not usually violent, but will allow corrosive potassium hydroxide to attack the amplifier. I found it best to rough up the battery posts with sandpaper first. Then tin a small spot (approximately 1/8 inch in diameter) in the center of each post. Use a hot iron and work fast (no longer than 1 second). Pre-tin the wires before attempting to complete the connections. The

batteries can then be easily "tacked" together with less danger of damaging the cells.

Install the batteries in the battery compartment and complete all connections with the exception of the +27-volt lead. Bring the +27-volt battery lead and the B+ lead from the amplifier temporarily outside the bottom of the case, for tuneup measurements. Insert a 0-10-mA meter between these leads ("+" lead of meter to +27-volt battery lead).

The transistor must now be properly biased so that it operates within its class-B linear range. Short the alligator clips at the end of the input coax leads to eliminate any possible input signal. Initially set the wiper of R1 to the

ground-bus end. Depress S1 and adjust R1 for a meter reading of 4 mA. That's all there is to the bias adjustment.

Now the linear is ready to be tuned up for on-the-air operation. Change ranges on the milliammeter so that it will read up to 250 mA. Collapse the walkie-talkie whip and to it clip the input coax from the linear. The linear whip must, naturally, be fully extended. Tuneup is best done with an absorption-type wavemeter (a grid-dip oscillator in the "diode" position). The S-meter on your CB rig will work just as well if the CB antenna is removed and a one-turn pick-up link substituted. This is necessary to avoid blocking your receiver and pegging the S-meter.

continued on page 66

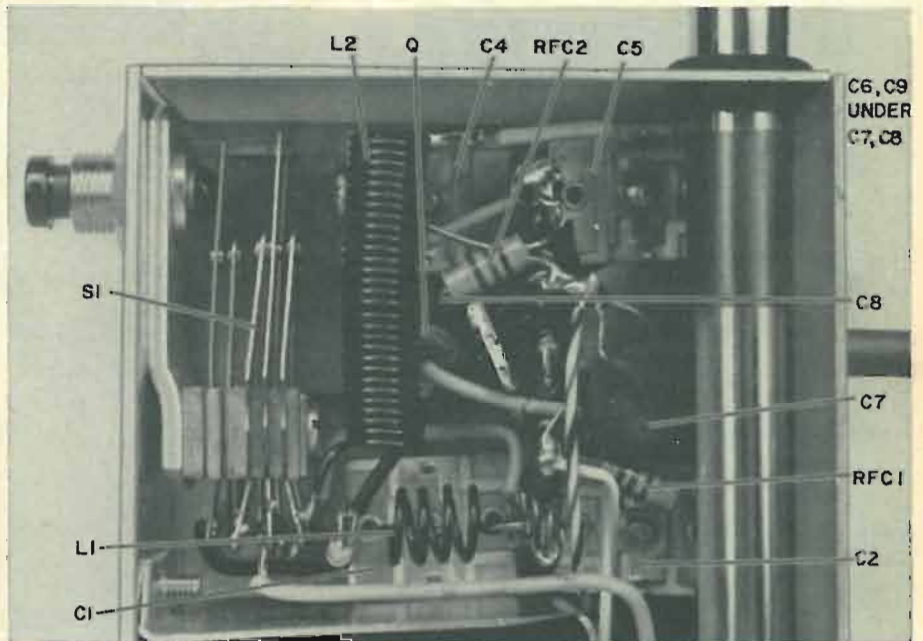

Here are details of switch S1 after modification, and placement of some components.

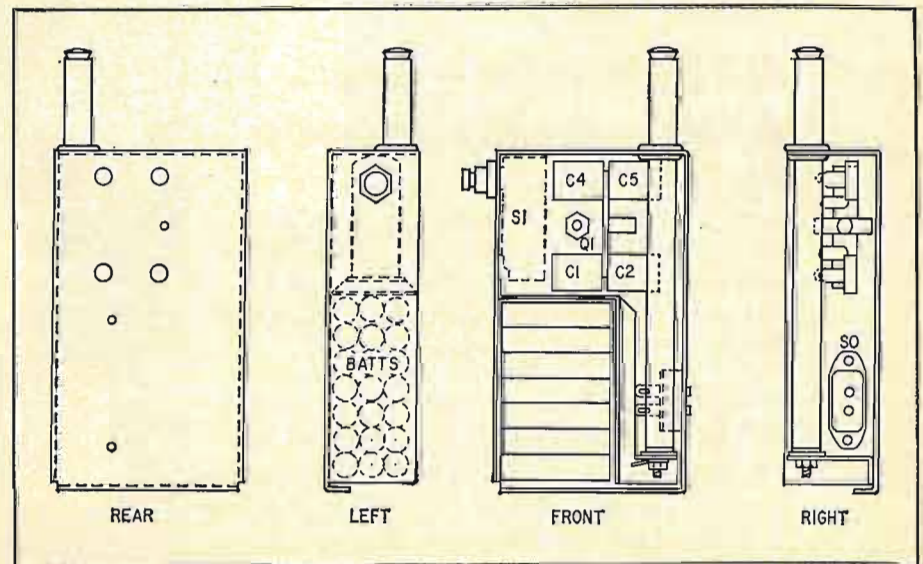

Fig. 2—This shows layout of components and mounting holes in the amplifier cabinet.

TAKE THE FIRST BIG STEP TOWARD A REWARDING CAREER IN ELECTRONICS

Mail card to RCA Institutes today

**Thousands of well paid jobs for
Electronics Technicians are
unfilled now**

***RCA Institutes Can Train You—
At Home—And Help You Qualify
For This Work***

It's a sad, but true, fact that today, with so many men yearning for better jobs and better incomes, thousands of well paid jobs are unfilled in the vast electronics industry.

Many of the men who could fill these jobs—that is, men with the aptitude and native interest to enjoy a career in electronics—are handicapped because for one reason or another they have not had the opportunity to train themselves for these lucrative positions.

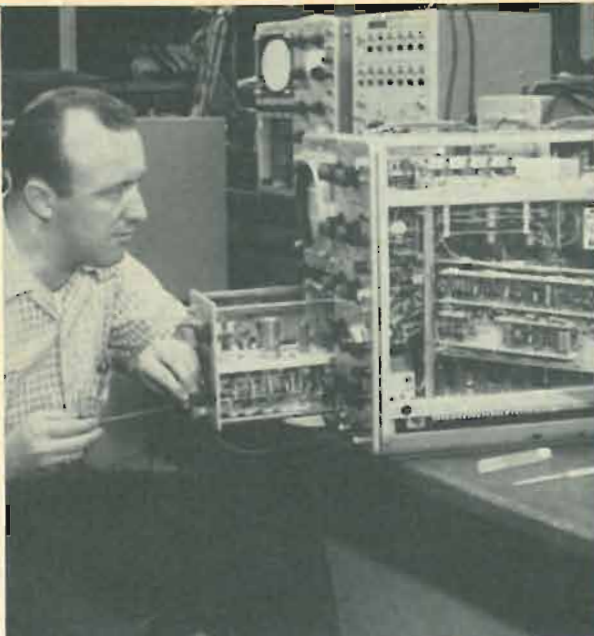

Thousands of well paid jobs for men skilled in electronics are unfilled now

RCA INSTITUTES CAN TRAIN YOU —AT HOME—AND HELP YOU QUALIFY FOR JOBS LIKE THESE!

Every Sunday—and most week days—you will find *The New York Times*, *The Houston Chronicle*, *The Los Angeles Times* and many, many other newspapers cram-full of ads like these. Actively seeking qualified men for jobs in electronics and related fields.

Many of the men who *could* qualify for these jobs—well paid jobs—that is, men with the aptitude and native interest to enjoy a career in electronics—are handicapped because for one reason or another they have not had the opportunity to train themselves for jobs like these.

NOW—THANKS TO RCA INSTITUTES HOME STUDY—YOU CAN TRAIN FOR A CAREER IN ELECTRONICS

Realizing that thousands of technical jobs—well paid jobs—in electronics are or will be available, RCA Institutes has done something positive about the problem. To help sincerely interested men to get started toward a well-paid electronics job, RCA offers an ideal home training program!

HOME STUDY CAN PROVIDE CAREER OPPORTUNITIES!

To help meet the need for qualified men in the electronics field, RCA Institutes has created a wide variety of Home Training Courses, all geared to a profitable, exciting electronics career in the shortest possible time. Included are exclusive "Career Programs" designed to train you quickly for the job you want! Your study program is supervised by RCA Institutes experts who work with you, help

guide you over any "rough spots" that may develop along the way.

OFF TO A FLYING START WITH AMAZING RCA "AUTOTEXT" METHOD

Each "Career Program" starts with the amazing "AUTOTEXT" Programmed Instruction Method—the new, faster way that's almost automatic! "AUTOTEXT" helps even those who have had trouble with conventional learning methods in the past. It is truly the "Space Age" way to learn everything you need to know with the least amount of time and effort.

RCA INSTITUTES ENGINEERED KITS SPEED YOUR PROGRESS

To speed you on your way to a successful electronics career, your "Career Program" will include a variety of RCA Institutes engineered kits at no extra cost—each complete in itself. As a bonus, you will also receive and build a valuable Oscilloscope. You'll get the new Programmed Electronics Breadboard for limitless experiments, including building a working signal generator and a fully transistorized superheterodyne AM receiver and Multimeter.

CHOOSE YOUR CAREER PROGRAM NOW

To get started today on the electronics career of your choice, look over this list of RCA Institutes "Career Programs", pick the one that appeals most to you, and check it off on the attached card:

- Television Servicing
- Telecommunications
- FCC License Preparation
- Automation Electronics
- Automatic Controls
- Digital Techniques
- Industrial Electronics
- Nuclear Instrumentation
- Solid State Electronics
- Electronics Drafting

To meet other specific needs, RCA Institutes also offers a wide variety of separate courses which may be taken separately from the "Career Programs". Those range from Electronics Fundamentals to Computer Programming. They are described in the material you receive.

ADVANCED TRAINING TOO

If you are already working in electronics or have some experience but want to move on up, you may start RCA Institutes training at an advanced level. No tedious repetition of work you already know!

UNIQUE TUITION PLAN

With RCA Institutes, you learn *at your own pace*, and you pay only as you learn. There are no long term contracts to sign . . . no staggering down-payments to lose if you decide to stop . . . no badgering bills. You pay for lessons only as you order them, and should you decide to interrupt your training at any point, you may do so and not owe one cent.

CLASSROOM TRAINING AVAILABLE

RCA Institutes Resident School is one of the largest schools of its kind in New York City with classroom and laboratory training available in day or evening sessions. Coeducational classes start four times a year. Just check "Classroom Training" on the attached card for more details.

FREE PLACEMENT SERVICE, TOO!

In recent years, 9 out of 10 Resident School students who used the Free Placement Service have been placed before or shortly after graduation. This service is now available to Home Study students.

SEND ATTACHED POSTAGE PAID CARD TODAY FOR COMPLETE INFORMATION. NO OBLIGATION FOR FREE BOOK AND DETAILS. NO SALESMAN WILL CALL.

RCA INSTITUTES, Inc., Dept. RE-37
350 West 4th Street,
New York, N. Y. 10014



The Most Trusted Name in Electronics

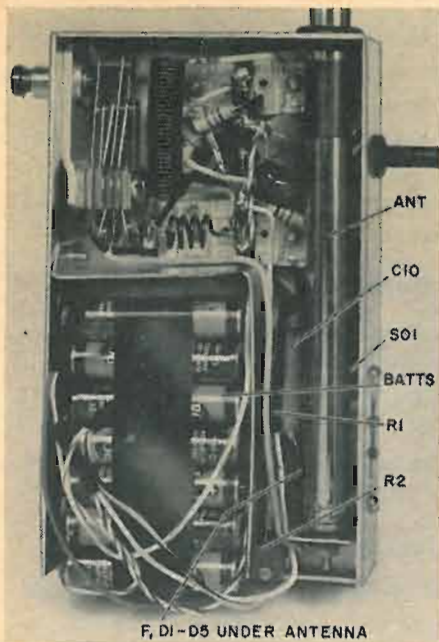

Arrangement of batteries in compartment. Use plastic tape as retaining strap and it will be easier to solder wire connections to the cells. Taped wire splices are necessary because a milliammeter must be inserted at this point for bias setting.

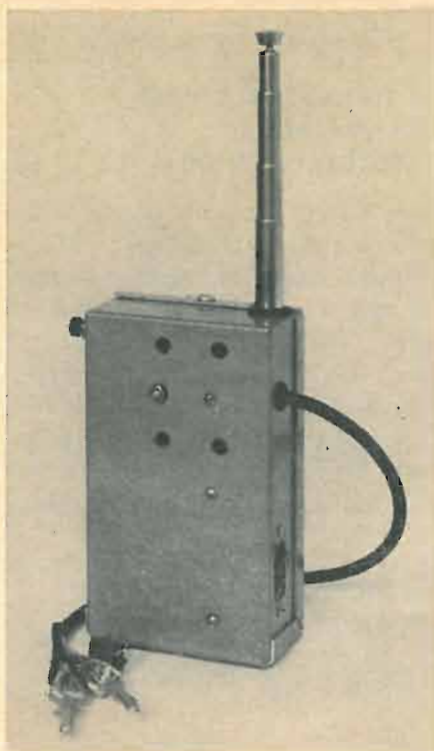

The finished amplifier. Chassis-mounted ac plug is used to rejuvenate batteries.

Position the whip on the linear close to the wavemeter coil or one-turn pick-up link. Depress both transmit buttons (S1 on the linear and its equivalent on the walkie-talkie). Now adjust C4 and C5 for maximum rf power indication consistent with minimum collector-cur-

rent indication on the 250-mA meter. Next adjust C1 and C2 to bring the collector current to 150 mA. Repeat the process at least once, since all adjustments interact somewhat. Be wary of very large increases of indicated rf power output resulting from small adjust-

ment changes, as this indicates that the linear has broken into oscillation and is spuriously radiating an uncontrolled signal. Tuneup is now completed. Remove the milliammeter, solder the wires permanently together, and install the chassis in the case.

After you've completed the linear, you should have it checked to see if it meets the requirements of Part 95 of FCC Regulations. Since your walkie-talkie will now be used as a licensed CB transmitter, oscillator frequency must be stable to within .005%. Rf output from the linear must not contain modulation over 100%, and spurious or off-channel radiation must be suppressed to certain limits. Anyone who's skilled in making such measurements, who holds an FCC commercial radiotelephone second-class (or better) license, and who has access to the necessary equipment, may check your rig. Once he's made the tests, the licensed technician should furnish you with a written certificate, stating that your transceiver complies with Part 95 of FCC Rules. If you already have a CB license, keep the certificate with it; the FCC may ask to see it.

If you have no CB license, you'll have to get one. You can write to the Federal Communications Commission, Washington, D.C. 20555, and ask for Form 505. Fill out this application and attach to it the certificate on the linear. On Form 505, list the make and model of your transceiver as "composite crystal-controlled." You might also list the make and model of the 100-mW transceiver.

REFERENCES

1. Motorola Data Sheet DS 5072 (2N3296), Motorola Semiconductor Products, Inc., March 1964.
2. Hejhall, Roy C., "Getting Transistors into Single-Sideband Amplifiers," *Electronics*, June 1, 1964.
3. Crane, Arthur T., "Low Voltage Power Supply," *Electronic Design*, April 12, 1965.
4. Yeaple, F. D., "How Much Can You Get Out of a Re-charged Cell?" *Product Engineering*, March 28, 1966. END

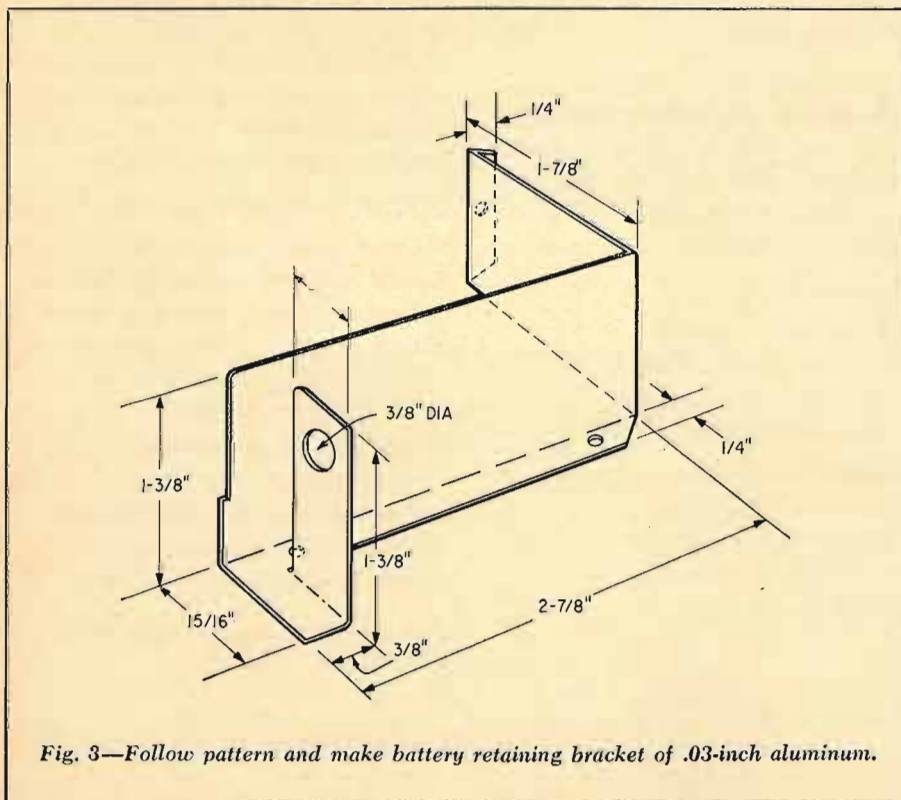

Fig. 3—Follow pattern and make battery retaining bracket of .03-inch aluminum.

FCC Issues Warning

Just before Christmas 1966, the FCC reminded persons buying walkie-talkies of rules governing their use. Only transceivers with 100 mW or less of dc input to the final rf amplifier may be used license-free. Such units may be used to communicate only with other license-free transceivers. If there is communication with licensed CB stations, the 100-mW unit must also be licensed as a CB station.

When buying a transceiver, check the certificate (usually on the back or inside of the case). If certified under Part 15, the unit may be used license-free; if under Part 95, a CB license is required.

EQUIPMENT REPORT

Lectrotech U-75 UHF Translator

Circle 25 on reader's service card



HERE IS A SOLID-STATE UHF TRANSLATOR cut just about to the bare essentials. It does a good job, even a better job than some more elaborate ones—under certain conditions.

This translator does not use any vhf amplification but does have a tunable vhf input that permits a good match to the translator section. No amplification means the input signal must be quite high (Lectrotech suggests it should be at least 2,500 μ V) for a good clean output. Since there is no vhf oscillator in this translator, the uhf dial calibration is valid only if the input is at 69 MHz. This means that if the input is on channel 2, 3, or 4 the uhf calibration will be slightly high, while on channel 5 or 6 it will be slightly low. You will have no problem if you realize it's normal.

The lack of a vhf oscillator is an asset since it eliminates a source of beats that could be a problem—especially when you interconnect translators and vhf signal generators to align uhf television receivers.

I connected the U-75 to a uhf TV set and to an outside antenna. The pictures could have been better; but, considering that where I live the vhf input signal is usually below 500 μ V and never reaches 2,500 μ V, the results weren't surprising.

I left the uhf side connected but hooked the vhf input to a color-bar generator with output on channel 3. I got a good dot/bar and color-bar pattern on

uhf. The adjustment of the vhf input control was slightly critical, though not intolerably so.

The diagram is a schematic of the vhf input circuit and a block diagram of the translator section. Note that vhf inputs for both 75 and 300 ohms are provided. This permits using either coaxial cable or twin lead. Of course the 75-ohm input is best for most signal generators.

A planetary tuning system on the uhf translator section moves the dial rapidly after a quarter-turn of the small knob. During the first quarter-turn, the tuning speed is much lower, for easy fine tuning.

The translator should be a useful piece of gear for any technician in a uhf area—especially so if he also happens to live where vhf signals are strong. But I think it's even more desirable for use with test equipment since beats are absent even with a strong signal input. One thing that may be a little critical with some uhf tuners is the length of wire between the translator and the set. Test this by grabbing the twin lead and noting whether there is a drastic change in picture output. If there is, shorten or lengthen the lead and try again. Even a slight change in length will usually cure the trouble, particularly on one specific channel.

The U-75 operates on a self-contained 9-volt snap-on battery.—*Wayne Lemons*

Price: \$39.50

TWO MYSTERIES OF SCIENCE...

lightning phenomena and UFO's will both be explored in a comprehensive article by our science editor. If you want to be prepared for strange things you may see in the sky this summer, read "Lightning, Plasmas, and Balls of Fire" in

April RADIO-ELECTRONICS

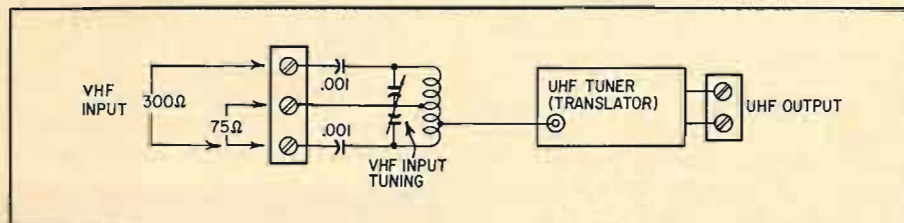

COMPLETE TUNER OVERHAUL

9.95

ALL LABOR AND PARTS
(EXCEPT TUBES & TRANSISTORS)*

COLOR TUNERS **GUARANTEED COLOR ALIGNMENT — NO ADDITIONAL CHARGE**

Simply send us the defective tuner complete; include tubes, shield cover and any damaged parts with model number and complaint. Your tuner will be expertly overhauled and returned promptly, performance restored, aligned to original standards and warranted for 90 days. UV combination tuner must be single chassis type; dismantle tandem UHF and VHF tuners and send in the defective unit only. Exact Replacements are available for tuners unfit for overhaul. As low as \$12.95 exchange. (Replacements are new or rebuilt.) And remember—for over a decade Castle has been the leader in this specialized field... your assurance of the best in TV tuner overhauling.

CASTLE
TV TUNER SERVICE, INC.

5715 N. Western Ave., Chicago 45, Illinois
41-96 Vernon Blvd., Long Island City 1, N. Y.

For service in Canada write to Chicago or use reader service card in this magazine.
*Major parts are charged extra in Canada.

Circle 26 on reader's service card

HI-FI PROBLEM ? !
Need another MAG input on your pre-amp?

TAPE PROBLEM ? !
Need equalization for a direct connection between tape head and hi-fi pre-amp?

MIKE PROBLEM ? !
Need boosted output? Losing "Highs"?

SMILE!

This one line pre-amplifier solves all these problems—and more:

SHURE M61
STEREO AMPLIFIER

Just one of several specialized pre-amplifiers by Shure. Write for all the interesting facts:

SHURE BROTHERS, INC.
222 Hartrey Avenue
Evanston, Illinois 60204

Circle 27 on reader's service card

join the
P.O.M. Club!

(Photofact-of-the-
Month Club)

get full data coverage of
COLOR TV!



AT LEAST
6 COLOR TV
FOLDERS MONTHLY

only **PHOTOFACT**[®]
gives you the up-to-the-
minute data and know-how
you need to perform expert
Profitable Color TV Servicing

(and P.O.M. membership now brings
you 20% more coverage monthly,
including at least 12 b&w TV
Folders, plus AC-DC, FM-AM, Stereo
Hi-Fi, Record Changer, and Phono-
graph coverage—at least 50 chassis
each and every month—for less
than 20¢ per chassis model!)

Act today—see your
SAMS Distributor

EQUIPMENT REPORT continued

Auto TV Antenna

Circle 28 on reader's service card

SPREADING ITS DIPOLES IN THE GRACE-
ful appearance of lengthy horns on a
gazelle, JFD's new model ATV111 tele-
vision antenna clamps on the window
glass of an auto. The "horns"—the
chrome-plated dipoles—extend neatly
above the car top.

Inside, the 72-ohm coaxial lead
plugs into a small plastic "black box"
that fastens to the television receiver.
Besides matching the coaxial lead-in to
the 300-ohm antenna input of the set, the
black box has a six-position switch that
helps eliminate directional ghosts.

I tried the ATV111 in a moving car
and as an indoor antenna clamped to
the rear cover of a color set. It's easy to
clip over the door glass or to any thin
flat object. I ended up clipping it on a
piece of Masonite screwed to my work-
bench.

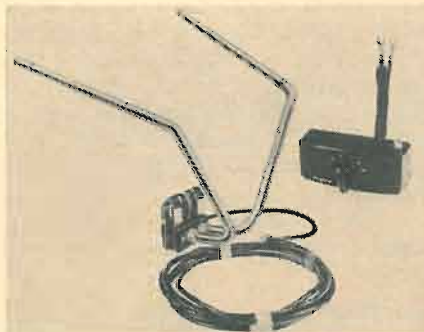

As an indoor rabbit ears, it worked
fine on all black-and-white channels.
Even drew acceptable uhf pictures. It
pulled good color on the low channels,
but color was weak on the higher chan-
nels. I checked at the receiver's video
detector with a scope; the burst was just
too weak on the high bands even
though signal strength measured fairly
good.

On a b-w portable in the car, the
ATV111 ran circles around the set's
built-in antenna. On the highway it was
great, though it had a tough time coping
with ghosts in the concrete canyons of
Manhattan. The switch took care of
curves and turns on the road.

With 12-volt transistorized porta-
bles becoming so popular in cars and on
boats, the ATV111 will probably be
popular, too. A back seat full of small
children on a long trip has always been
a problem for motoring parents. This
antenna and a portable TV will keep the
kids busy.—Larry Allen

Price: \$19.95

68

join the
P.O.M. Club!

(Photofact-of-the-
Month Club)

let the exclusive features of
PHOTOFACT[®]
troubleshoot for you in minutes!

OVER 40 GREAT FEATURES, INCLUDING:



Famous Standard Notation Schematic—always uni-
form, accurate, complete—
includes waveforms, volt-
ages and test points, align-
ment points, parts values,
tube functions, etc.



Full Photo Coverage of the
actual equipment makes
identification of all compo-
nents and wiring easy—you
can see everything.



CircuiTrace[®] saves printed
circuit board tracing time.
This exclusive Sams sys-
tem pinpoints junctions
and test points on schemat-
ic and printed board.



Tube Location Guide en-
ables you to locate and re-
place proper tubes in sec-
onds—a big time-saver on
many repair jobs.



Unique Alignment System
eliminates guessing; you
get complete instructions
with response curves, how
to connect test equipment,
proper adjustment se-
quence.

PLUS THESE IMPORTANT TIME-SAVERS:

- Tube Failure Check Charts
- Disassembly Instructions
- Field Servicing Notes
- Terminal Identification
- Complete Replacement Parts Lists
- Alternate Tuner Data
- Resistance Charts
- Dial Cord Diagrams
- Changer "Exploded Views," etc.

**PHOTOFACT GIVES YOU EVERYTHING
YOU NEED TO EARN MORE DAILY!**

Act today—see your
SAMS Distributor

Mercury 1800 Vom

Circle 30 on reader's service card

THE VOLTOHMMETER IS GOING TO BE even more popular in the future than it is now. Although I used to use mine mostly as a portable tester to be carried in my truck for use in homes, cars, etc., it's going to be more and more of a bench instrument. Provided with proper ranges, the vom can be a great time-saver in the shop, for big color sets and all kinds of transistor work.



The Mercury 1800 is one of the new breed of vom's. It has all the standard ranges, with new ones added at top and bottom. The lowest dc range is 0.25 volt, full scale, followed by an 0-1-volt range. These are our bias-reading scales for transistor equipment. With the fully isolated vom, we can take voltage readings between base and emitter, without having to worry about possible "hot" grounds.

At the top, an 0-5,000-volt range has been added. This is just right for focus voltages on color tubes. Their voltages run from 3,500 to 5,000—the average seems to be around 4,500 volts, which is the bogie value for most color CRT's.

The Mercury 1800 has a full-wave bridge meter rectifier for ac voltage ranges: 0-2.5, 0-10, 0-50, 0-250, 0-1,000 and 0-5,000, at 5,000 ohms per volt. Don't forget you can use this vom on the ac scale for making gain checks, signal-tracing tests in transistor radios and stereo amplifiers, with an audio signal generator as a source of constant signal.

The ohms scales go up to a 20 megs full scale. The lowest ranges are powered by a 1.5-volt battery, making the vom safe for any transistor or di-

ode. The $R \times 10K$ range uses only a 6-volt battery, and even small transistors will handle that. The high ohms scale is useful for finding diodes with a nice high front-to-back resistance ratio, and so on.

The 1800 has a dc range from 10 amps, handy for modern car radios, down to $50 \mu A$. The 10-amp range is good for finding off-bias conditions in car radios, as well as in high-powered stereo amplifiers with transistor outputs. The microamp scale is useful for a lot of things—reading test currents in two-way radios, grid currents, and any other test which requires high current sensitivity. (With a diode, it makes a handy little field-strength meter for tuning up peanut-size CB handie-talkies!)

The 0-1-mA scale is fine for reading high-voltage regulator cathode-current ranges in color sets. The 0-10- and 0-100-mA ranges suit any kind of transistor radio, and the 0-500-mA scale reads horizontal output tube cathode currents in any TV, b-w or color.

This meter has one thing, rarely found in vom's, that I like: calibration adjustments! Inside the case, at one end of the parts board, there are three pots: one for low ac volts ranges, another for high ac volts, and the third for dc.

The 1800 is rated at 2% accuracy on dc voltage and current ranges, and reads true rms on ac voltages. All dc scales are at 20,000 ohms per volt, with ac at 5,000 ohms per volt.

A dB scale with four ranges is provided for output measurements. The zero-dB point on the lowest range equals 0.775 volt across a 500-ohm load. This function is handy for checking channel separation in stereo equipment. By setting one channel output at any desired dB level, you can read the output of the other channel, and so on. The dB scale is read directly, adding a certain amount each time you go to a higher scale. The 250-volt scale, for example, adds 40 dB to the scale reading.

The instrument is surprisingly light. PC board construction is used, and the case is made of what looks like a more flexible, tougher plastic than the old ones. (I didn't quite dare drop it to see, but it does look as if it would stand a pretty good jolt without cracking.) A leather handle on top makes the 1800 easy to carry, and can be tucked under for use as a rest on a bench.

The meter is big enough to see from a good distance; it has a 5-inch rectangular face. For what it will do, and by comparison with meters I have used, the Mercury 1800 is a lot of meter for the money.—*Jack Darr*

Price: Kit, \$26.95.
Wired, \$34.95.

END

Join the P.O.M. Club!

(Photofact-of-the-
Month Club)

ONLY \$10 PER MONTH
brings you 20% MORE
PHOTOFACT® coverage!



As a P.O.M. member, you get 6 new PHOTOFACT Sets every month to keep you ahead earning more—and you SAVE OVER \$60 PER YEAR! (Individually purchased Sets now sell for \$2.50 each.) Your 6 Sets come in sturdy file folders sealed in factory carton to insure perfect condition and completeness—easier-than-ever to file and use. To stay ahead, to save money—join the P.O.M. Club today!

SEE YOUR SAMS DISTRIBUTOR
OR SEND ORDER FORM BELOW

HOWARD W. SAMS & CO., INC. Dept. REF-3
4300 W. 62nd St., Indianapolis, Ind. 46268

Enroll me in the Photofact-of-the-Month Club. I agree to pay \$10 per month, and understand I will receive 6 current Photofact sets monthly to be delivered by my Sams Distributor (named below).

Name _____

Shop Name _____

Address _____

City _____ State _____ Zip _____

My Sams Distributor is: _____

Signed: _____

Circle 29 on reader's service card

Quick-Checker for Controlled Rectifiers

A project for testing SCR's, Triacs, GTO's, etc.

By DON ANGLIN

ALTHOUGH AN OHMMETER CAN BE USED to check the condition of most semiconductors, a silicon controlled rectifier can't be checked by making resistance readings. The SCR (triode thyristor) is a three-junction (pnpn) device. Not all the junctions are available externally for testing, and an SCR will not conduct in the forward direction unless the break-over voltage is exceeded or a proper gate voltage is applied.

In testing, our primary objective is to find out whether the SCR will do its job. Will a small current fed to the gate properly control a large current in the anode circuit? If it will, the SCR is good. The checker will not furnish enough current to damage the most delicate controlled switch, yet it tests SCR's with anode current ratings up to 110 amps. It will check GTO's, Transwitches and Trigistors for turn-on sensitivity.

An economical way to check an SCR is to connect it in a standard lamp dimmer circuit (making sure not to exceed maximum voltage and current specs). If the SCR controls the lamp brilliance, it is good. If the lamp glows brightly at all times, the SCR is shorted. If the lamp cannot be turned on at all, the SCR is open or has low gate sensitivity.

The basic lamp dimmer circuit used is shown in Fig. 1. This simple gating circuit will furnish conduction angles only from 90° to 170°. A more elaborate circuit, which could control from 0° to 180° is not necessary for our purpose. There will be current through the load only when the SCR is "on," since the lamp is in series with the anode. Diode

D admits only positive half-cycles to the voltage divider R1-R2 so that the gate-cathode junction will not be damaged by reverse bias. Resistor R1 limits the maximum forward gate current to a safe value. R2 controls the forward bias applied to the gate. Waveforms at the gate, at the anode and across the load are shown in Fig. 2.

For the waveforms in Fig. 2-a, R2 is set so there is not enough gate voltage during any part of the cycle to fire the SCR. Therefore, there is no current through the load and the voltage from the transformer appears on the anode during the full cycle.

For Fig. 2-b, R2 is advanced so that the SCR just fires (minimum conduction angle). The applied voltage is present on the anode until the SCR fires (point A). Then the anode voltage drops to practically zero, and the applied voltage is across the load until the current through the load falls below the holding current of the SCR and allows it to turn off (point B).

For Fig. 2-c, R2 is at maximum, the SCR turns on about 10° after the anode goes positive, and conducts during most of the positive half-cycle. Note that the applied gate voltage never goes appreciably over the gate firing value because, once the SCR has fired, the gate-cathode is a forward-biased pn junction with a nonlinear voltage-current characteristic.

The complete Controlled-Rectifier Checker is shown in Fig. 3. It is a half-wave lamp dimmer operating from a filament transformer. Since only 6.3 volts is applied to the SCR being tested, and the maximum average current is less

than 100 mA, low-voltage, low-current SCR's and controlled switches may be tested safely. D, R1 and R2 furnish a variable gate signal to the SCR being tested, and the load lamp (I1) will be out when R2 is fully counterclockwise unless the SCR is shorted. As R2 is rotated clockwise, the gate drive is increased until the SCR fires and the lamp glows. Low-current SCR's require only a small gate current to fire, and the load lamp will glow when R2 is rotated about 30%. Larger (35- to 110-amp) SCR's will not fire until R2 is at 70% to 80%. As R2 is increased, the conduction angle of the SCR increases, and the lamp gets brighter. R2 can be calibrated and used to compare gate sensitivities of different SCR's.

S2 is used only for checking bidirectional triode thyristors, such as the Triac. When S2 is open, D allows only positive pulses on the gate, protecting the conventional unidirectional thyristor from being reverse-biased. The bidirectional thyristor is a five-layer (nnpnp) device, and will conduct on both halves of the ac cycle provided it is gated on during positive and negative half-cycles. Closing S2 shorts out D and furnishes a bidirectional gate signal for checking the Triac. Do not press S2 when testing conventional SCR's.

The checker is built in a 3 x 5 x 4-inch two-piece aluminum box. Parts layout is not critical. Transistor socket (SO) is used for small SCR's and CS's. The anode, cathode and gate terminals are also brought out to tip jacks (J1, J2 and J3) so that clip leads can be used for checking larger controlled rectifiers. A deep-well transistor test socket (such as Pomona TS-187) is handy for SCR's with long leads and can be wired in

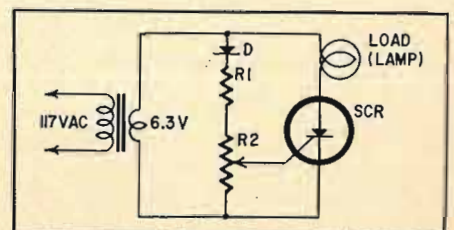
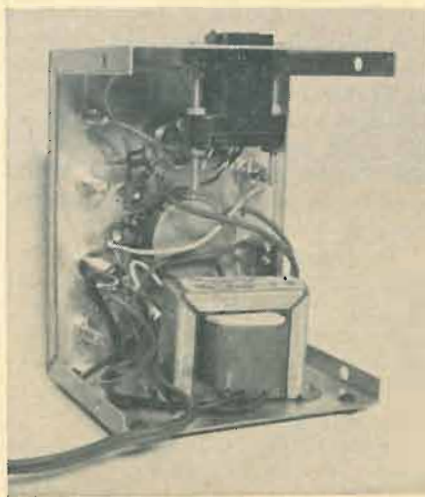

Fig. 1—Basic idea behind the checker: a simplified lamp-dimmer circuit. R1 is necessary to limit forward gate current.

Photos show (left) the completed tester in case, with symbol lines on panel to show connections to input jacks, and (right) parts mounting within the chassis.

A THYRISTOR BY ANY OTHER NAME . . .

The terminology manufacturers use to describe their thyristors is sometimes confusing. Basically, the four-layer thyristors can be grouped into two categories. First are the triode thyristors which can be turned on by a gate signal, after which the gate no longer controls the anode current. These are the semiconductor equivalent to the thyatron tube, and are generally called *controlled switches* if they are low-power devices, *silicon controlled rectifiers* if they can control large currents. The second group can be turned on and off by gate signals. Low power devices in this group are typified by Transitron's Transwitch and the Trigistor by Solid state Products, although some manufacturers use the terms *gate-turnoff switch* or *gate-controlled switch* (GCS). The high-current SCR's which can be turned off at the gate are generally called *gate-turnoff controlled rectifiers*, abbreviated GTO.

Tetrode thyristors are similar to conventional triode thyristors except that all four layers of the semiconductor are brought out to external leads, and the fourth lead is another control electrode. Examples are the *silicon controlled switch* (SCS) by General Electric and the Binistor by Transitron.

Another device you may encounter is the Dynaquad made by Tung-Sol. It is a low-power germanium npnp device which can be turned on and off at the gate. Signal polarities required are opposite to those for pnpn silicon devices. It must have a negative voltage on the collector and a negative signal on the gate for proper operation. **Do not use this tester to check the Dynaquad. The gate signal has wrong polarity.**

parallel with SO. Thyristor basing diagrams are shown in Fig. 4.

The gate signal has been brought out to J4 and J5, and the voltage across the load is available at J6 and J7, so that an oscilloscope can be used to monitor the control action of the SCR being tested. Fig. 5-a shows the waveform across the load at the minimum conduction angle, and Fig. 5-b shows maximum conduction angle. Fig. 6-a shows the waveform across the SCR (J5 to J7). Fig. 6-b shows the gate waveform at minimum firing angle. Note the abrupt voltage change when the SCR fires. (Transients like this can cause radio interference if allowed to get back into the ac line. Therefore they must be suppressed.)

END

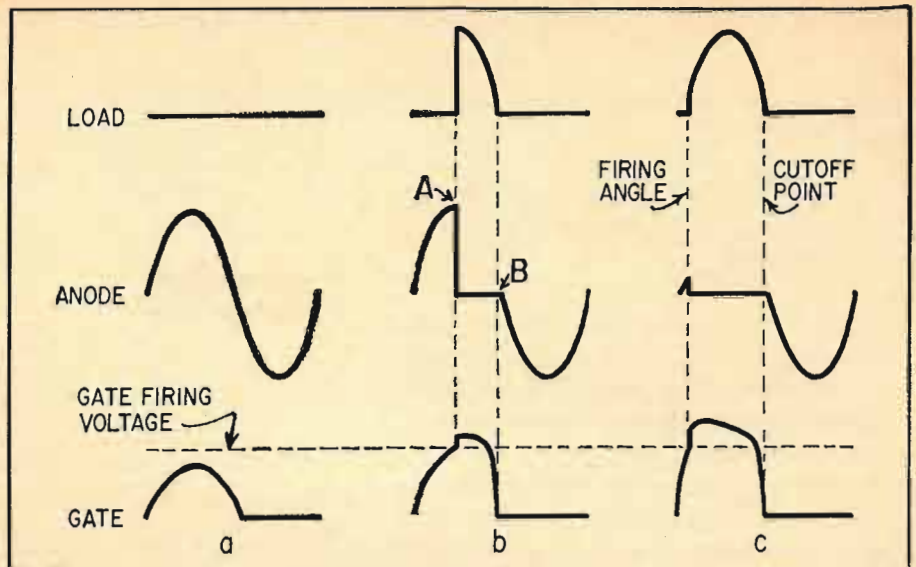

Fig. 2—These waveforms show what occurs inside the checker for three settings of R2.

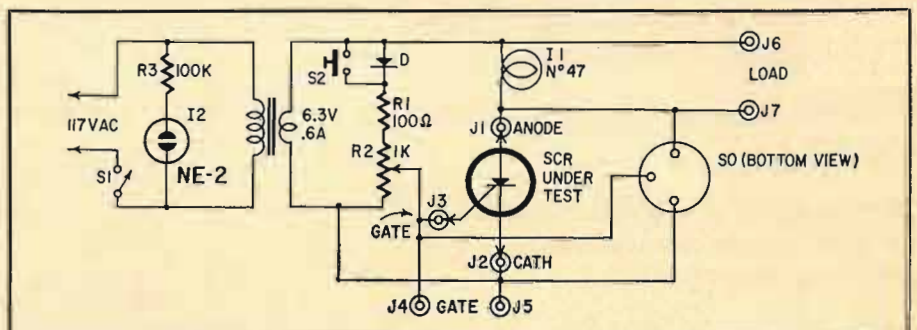

Fig. 3—Complete schematic of the checker. Gate signal at J4-J5 is for scope display.

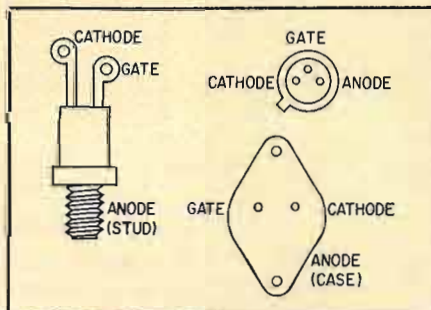

Fig. 4—Three thyristor-terminal layouts.

- D—silicon rectifier, 50 volts, 750 mA or better (1N536 or equivalent)
- I1—No. 47 pilot lamp (6.3 volts, 0.15 ampere)
- I2—neon lamp (NE-2 or similar)
- J1—J7—tip or banana jacks
- R1—100 ohms, 1/2 watt
- R2—pot, 1k, linear taper
- R3—100k, 1/2 watt
- S1—spsst toggle switch
- S2—spsst pushbutton, normally open
- SO—transistor socket (Elco 05-3301)
- T—filament transformer, 6.3 volts, 0.6 amp (Stancor P6465 or equivalent)
- Two-section aluminum cabinet, 3 x 4 x 5 inches
- Miscellaneous hardware

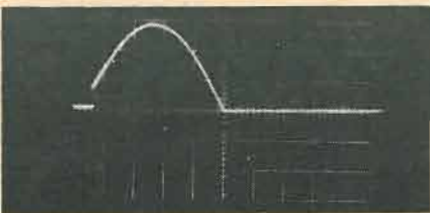
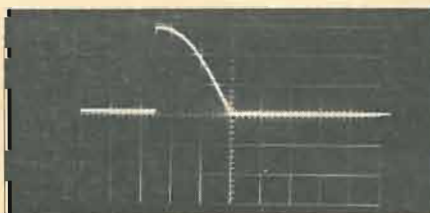

Fig. 5—Waveform across load at minimum (a) and maximum (b) conduction angles.

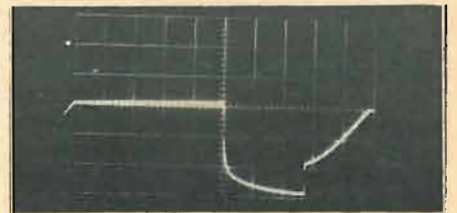
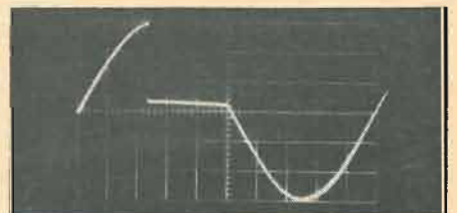

Fig. 6—Waveform across the SCR (a) and at gate (b) at minimum firing angle.

RADIO-ELECTRONICS READER'S SERVICE

Here's how you can get manufacturers' literature fast:

1. Tear out the post card on the facing page. Clearly print or type your name and address.
2. Circle the number on the card that corresponds to the number appearing at the bottom of the **New Products, New Literature** or **Equipment Report** in which you are interested.
For literature on products **advertised** in this issue, circle the number on the card that corresponds to the number appearing at the bottom of the advertisement in which you are interested. Use the convenient index below to locate quickly a particular advertisement.
3. Mail the card to us (no postage required in U.S.A.)

Advertisements in this issue offering free literature (see the advertisements for products being advertised):

ALLIED RADIO CORP. (Pg. 22)	Circle 18
AMPEREX ELECTRONIC CORP. (Second Cover)	Circle 7
ARROW FASTENER CO., INC. (Pg. 91)	Circle 125
B & K MANUFACTURING CO., INC. (Pg. 15)	Circle 15
BLONDER-TONGUE (Pg. 26)	Circle 22
BRACH MANUFACTURING CORP. (Pg. 93)	Circle 130
BROOKS RADIO & TV CORP. (Pg. 92-93)	Circle 129
BURSTEIN-APPLEBEE CO. (Pg. 85)	Circle 120
CASTLE TV TUNER SERVICE, INC. (Pg. 67)	Circle 26
CENTRALAB (DIV. OF GLOBE-UNION INC.) (Pg. 14)	Circle 14
CLEVELAND INSTITUTE OF ELECTRONICS (Pg. 5)	Circle 9
CORNELL ELECTRONICS CO. (Pg. 98)	Circle 138
DATAK CORP. (Pg. 76)	Circle 108
DELTA PRODUCTS, INC. (Pg. 78)	Circle 113
DE VRY TECHNICAL INSTITUTE (Pg. 7)	Circle 11
EASTMAN KODAK CO. (Pg. 17)	Circle 17
EICO ELECTRONIC INSTRUMENT CO. (Third Cover)	Circle 149
EDMUND SCIENTIFIC CO. (Pg. 97)	Circle 136
FINNEY CO. (Pg. 76)	Circle 107
FINNEY CO. (Pg. 90)	Circle 123
HEALD ENGINEERING COLLEGE (Pg. 91)	Circle 127
HEATH CO. (Pg. 86-89)	Circle 122
INTERNATIONAL CRYSTAL MFG. CO., INC. (Pg. 100)	Circle 148
JERROLD ELECTRONICS CORP. (DISTRIBUTOR SALES DIV.) (Pg. 13)	Circle 13
MALLORY DISTRIBUTOR PRODUCTS CO. (Pg. 77)	Circle 111
MIKE QUINN ELECTRONICS (Pg. 90)	Circle 124
MUSIC ASSOCIATED (Pg. 76)	Circle 109

HELP THE EDITOR PLAN FUTURE ISSUES!!

At the bottom of the Reader's Service Card, you'll find numbers from 1 through 6. Read the following question and then circle your answers on the Reader's Service Card.

I WANT THE FOLLOWING KINDS OF ARTICLES:

(Circle appropriate numbers on RS card)

- 1 Projects to build
- 2 How to troubleshoot and repair
- 3 Interviews with electronics celebrities
- 4 Reports on the electronics industry
- 5 Theory, with some math
- 6 Theory, no math

OLSON ELECTRONICS, INC. (Pg. 91)	Circle 126
PERMOFLUX CORP. (Pg. 92)	Circle 128
POLY PAKS (Pg. 99)	Circle 139
QUAM NICHOLS CO. (Pg. 25)	Circle 21
QUIETROLE CO. (Pg. 76)	Circle 110
RADAR DEVICES (Pg. 1)	Circle 8
RYE INDUSTRIES, INC. (Pg. 80)	Circle 115
S & A ELECTRONICS, INC. (Pg. 81)	Circle 116
SAMS & CO., INC., HOWARD W. (Pg. 16)	Circle 16
SAMS & CO., INC., HOWARD W. (Pg. 68, 69)	Circle 29
SCHOBER ORGAN CORP., INC. (Pg. 75)	Circle 106
SCOTT, INC., H. H. (Pg. 25)	Circle 100
SENCORE (Pg. 24)	Circle 20
SENCORE (Pg. 82)	Circle 117
SHURE BROS. (Pg. 67)	Circle 27
SOLID STATE SALES (Pg. 97)	Circle 137
SONOTONE CORP. (ELECTRONIC APPLICATIONS DIV.) (Pg. 23)	Circle 19
SONY CORP. OF AMERICA (Pg. 12)	Circle 12
SONY CORP. OF AMERICA (Pg. 27)	Circle 23
SPRAGUE PRODUCTS CO. (Pg. 79)	Circle 114
SURPLUS CENTER (Pg. 94)	Circle 131
TURNER MICROPHONE CO., THE (Pg. 83)	Circle 118
WARREN ELECTRONICS COMPONENTS (Pg. 96)	Circle 135
WELLER ELECTRIC CO. (Pg. 84)	Circle 119

NEW PRODUCTS

More information on new products is available free from the manufacturers of items identified by a Reader's Service number. Turn to the Reader's Service Card facing page 72 and circle the numbers of the new products on which you would like further information. Detach and mail the postage-paid card.



lift for single-record play. Automatic shut-off and repeat. Cueing lever permits pickup arm to be raised or lowered in any spot without record or stylus damage. 7-, 10-,



SEMIFIXED 1-FREQUENCY FM TUNER, model 651, for use with wireless microphones and wireless musical instruments employing 88-108 MHz. Tunable. Positive squelching automatically silences audio when transmitter is turned off or signal-to-noise ratio falls below usable level. Reproduces 20-20,000 Hz. Separate output jacks. Plug-in vertical antenna, connections for external antennas of 72 and 300 ohms. One 6GH8A tube, three 6AU6 tubes, silicon transistor, silicon diode, silicon power rectifier, three germanium diodes. Tan metal cabinet. Also available in standard rack panel. 9½ x 7 x 12¼ in. \$85.—Truetone Electronics, Inc.

Circle 46 on reader's service card



"BLACK LIGHT" KIT, stock No. 70,256, for variety of ages and interests. Contains 6W filter-type black-light bulb, starter, switch, electrical connections, power cord and complete instructions. Invisible water paints and ink, 3 brushes, pen, tracer powder, fluorescent crayon and fluorescent minerals. Book of 40 experiments. \$14.50.—Edmund Scientific Co.

Circle 47 on reader's service card

AUTOMATIC TURNTABLE, the MacDonal 500. Stylus pressure controlled by micrometer-like settings, 1/3 gm

adjustment 0-6 gm. Pickup arm supported by horizontal ball-bearing pivots. Specially designed mechanism protects arm against accidental overload. Mono or stereo cartridges. Arm locks automatically when machine turns off. Finger-



INTRODUCING THE NEW
Schober
Theatre Organ

Build it yourself and
save over 50%

The only Theatre Organ available in kit form — for only \$1350.

You've asked for it and here it is — the NEW Schober THEATRE ORGAN that you assemble yourself. For the first time in kit form, a real Theatre Organ with that rich, full, old time theatre pipe organ sound. You create the organ, then you create the music!

For years you've been able to buy organs in kit form from Schober: The Recital (fully AGO), the Console II (the best spinet organ available today) and the Spinet (for the most music at the lowest price). Now to join them, we present the Schober Theatre Organ.

The Schober Theatre Organ has the same quality features found on all Schober Organs, and in addition... special voicing, curved console design, two 61-note keyboards, 2-octave radiating pedal claviers, 8 octaves of tone distributed over 5 pitch registers (including a 1-foot register!), 35 speaking organ stops, 8 realistic percussion stops, 4 couplers, and vibrato tablet—48 tablets in all. And all at a truly remarkable low price... you save over \$1,500 (well over 50%) from comparable theatre organs.

Easy Step-By-Step Instructions.

You'll enjoy assembling this authentic and versatile instrument from transistor and miniature components too. Just follow easy step-by-step instructions written in everyday language which anyone can understand. You'll have an unequalled pride when you're finished that only can come from assembling it yourself.

And you'll have an organ you can learn to play easily and quickly—just follow one of the self teaching courses available from us.

The Theatre Organ price starts at \$1,350, depending on the options you select. This price includes a beautiful walnut console (other woods available) or you can save an additional amount by building your own from plans available from us. Options available include combination action, genuine reverberation, percussion, and amplifiers and speakers.

THE *Schober Organ* CORPORATION
43 West 61st Street, New York, N.Y. 10023

A COMPLETE THEATRE ORGAN!
All you do is have the fun of assembling it from kits and detailed, step-by-step instructions.

Includes console, keyboards, bench, pedals, electronics—everything you need except amplifier and speaker system, which are extra—or use your own. Percussions, combination action, and reverberation are options.

Features fully transistorized electronics, regulated power supplies, all printed circuit construction and gold switch contacts.

Combination Action Ten buttons select preset combinations of stops—actually move the stop tablets as in fine pipe organs—to give instant total changes of tonal effects. You can alter the preset combinations any time you like. Action is brand new electro-pneumatic type — silent, dependable.

Percussion Eight percussion stops provide exciting realism. Celesta, harpsichord, piano, mandolin, xylophone, chrysoglott, orchestral bells, single or reiterating, are played just like the real thing—and sound that way—alone or along with regular organ stops.

*Uncompromising Organ Quality
from Easy-to-Assemble Kits*

Free Information. Send today for your free copy of Schober's 16-page full-color booklet—plus free 7" recording—with full information on all Schober Organs, priced from \$550.

The Schober Organ Corp., Dept. RE-48
43 West 61st St., New York, N. Y. 10023
 Please send me Schober Organ Catalog and FREE 7-inch "sample" record.
 Enclosed please find \$2.00 for 12-inch quality LP record of Schober Organ music. (\$2.00 refunded with purchase of first kit.)

Name.....
Address.....
City.....State.....Zip No.....

Circle 106 on reader's service card

NEW POWER

FROM

FINCO

Model 65-3 VHF-TV ANTENNA AMPLIFIER

improves reception of WEAK VHF-TV signals in FRINGE AREAS even where strong local TV or FM signals are present. AMPLIFIES UP TO 7 TIMES for Better Color and B/W



Model 65-3 VHF-TV ANTENNA AMPLIFIER

Let Finco solve your Color and B & W reception problems. Write for complete information, schematics and specifications. Form #20-357.

A two-transistor-amplifier. Engineered to provide the lowest noise and highest amplification with the most desirable overload characteristics.

Amplifier used in conjunction with dual outlet power supply for one, two, or multiple set installations. 117 V 60 cycle input. AC power up to amplifier: 24 volts-60 cycle.

THE FINNEY COMPANY

34 West Interstate St. • Bedford, Ohio 44014 • Dept. RE

Circle 107 on reader's service card

Because you've got to SEE it to BELIEVE it
..... we will send you a FREE sample!

instant lettering



DATAMARK

— the easy new way to label your projects!

Just rub over the pre-printed words or symbols with a ballpoint pen and they transfer to any surface — looks like finest printing! Label control panels, meter dials, letter on anything!

LOOK FOR instant lettering

DATAMARK SETS only \$1.25 each — at leading electronic distributors

DATAMARK SETS AVAILABLE FOR:

- Amateur Radio, CB
- Audio, Hi-Fi, TV
- Experimenter Home Intercom
- Industrial Test Equipment
- Switch & Dial Markings
- Alphabets & Numerals in

1/8", 1/4" and 1/2"

— each set has black, white, and gold

SEND FOR FREE SAMPLE RE-37

THE DATA CORPORATION

85 HIGHLAND AVENUE • PASSAIC, N. J. 07055

Circle 108 on reader's service card

NEW PRODUCTS continued

12-in. records at 15, 33, 45, 78 rpm. Dynamically balanced, hum-shielded, 4-pole ac motor. 11-in. turntable.—BSR (USA) Ltd.

Circle 48 on reader's service card



TV/FM ANTENNA DISTRIBUTION AMPS, model HBV2 for 300-ohm; model HBV-75 for 75-ohm; up to 4 sets. Up to 7 dB to each set. Etched-copper circuit boards with poly-U sealant. Two frame-grid, low-noise tubes for vhf. Perforated gold housing, black base, bracket for vertical or horizontal mounting. Protective felt pads. Operation on 117 Vac at 20W. Model HBV2, \$29.95; model HBV2-75, \$34.95.—JFD Electronics Co.

Circle 49 on reader's service card

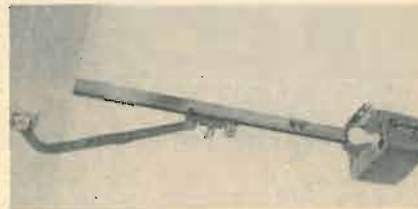

RADIO-CONTROLLED GARAGE-DOOR OPENER, the Genie model 401. One-piece cover removable with single screw. Front-mounted circuit components. Built-in time delay for garage light. Push-button or pocket-sized remote-control radio transmitter actuates unit. Model AR-15 radio receiver with nuvistor tubes automatically activates motor on Genie 401.—The Alliance Manufacturing Co.

Circle 50 on reader's service card



ANTI-STATIC RECORD SPRAY, Klear-Tone No. 1632-6S. Safe for all records including old shellacs. Nonflammable. Cleans and lubricates with silicone film, prevents static buildup. Spray-cleans needles and cartridges.—Colman Electronic Products

Circle 51 on reader's service card



23-CHANNEL 5W CB TRANSCEIVER, model 7923, the Nova-23. Dual-

76

Enjoy the "music-only" programs now available on the FM broadcast band from coast to coast.

- NO COMMERCIALS •
- NO INTERRUPTIONS •

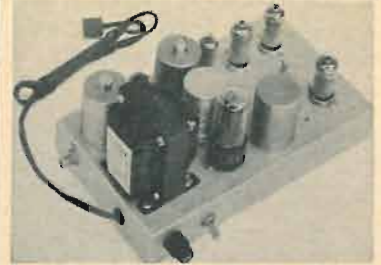

It's easy! Just plug Music Associated's Sub Carrier Detector into multiplex jack of your FM tuner or easily wire into discriminator. Tune through your FM dial and hear programs of continuous commercial-free music you are now missing. The Detector, self-powered and with electronic mute for quieting between selections, permits reception of popular background music programs no longer sent by wire but transmitted as hidden programs on the FM broadcast band from coast to coast. Use with any FM tuner. Size: 5 1/2" x 9". Shipping weight approx. 7 lbs.

KIT \$4950

(with pre-tuned coils, no alignment necessary)

WIRED \$7500 (Covers extra \$4.95 ea.)

Current list of FM Broadcast stations with SCA authorization \$1.00

MUSIC ASSOCIATED

65 Glenwood Road, Upper Montclair, N. J.
Phone: (201)-744-3387 07043

Circle 109 on reader's service card

Color or
Black & White TV
respond to
QUIETROLE
like magic!



- Lubricates & Cleans
- Non-inflammable . . . Non-conductive . . . Non-corrosive
- Easy Spray or Dropper Application
- Nearly 20 Years of Outstanding Leadership
- Harmless to Plastics & Metal — Zero Effects on Capacity & Resistance

Acknowledged leadership by both manufacturers and servicemen. Silences noisy TV and radio controls with minimum attention. Mark-II for tuners . . . Spray-Pack for controls and switches . . . Silitron for general use.

Ask your distributor for Quietrole by name.



manufactured by

QUIETROLE CO.

Spartanburg, South Carolina

Circle 110 on reader's service card

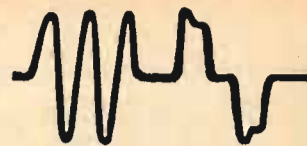

Which miniature electrolytics for transistorized AM-FM radios?

COMPARATIVE SIZES
OF CAPACITORS ALL RATED
10 MFD., @ 25 WVDC
(shown actual size)



TT aluminum electrolytic



MTA aluminum electrolytic



TAS solid tantalum



TAP wet slug tantalum

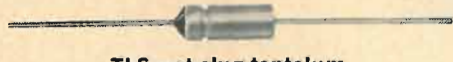

TLS wet slug tantalum

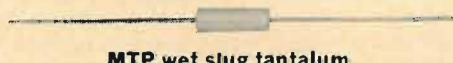

MTP wet slug tantalum

The new portable AM-FM radios are so compact you wonder how they get all those components into that little box. You wonder even more when you have to replace some of the parts.

Electrolytic capacitors, for example. The original electrolytic usually turns out to be a tiny thing jammed in among a dozen other midget gadgets. Getting it out is a trick in itself. Getting a suitable replacement is even tougher! And unfortunately, you're apt to need replacements, because many of these tiny capacitors just aren't much good. They don't meet the quality specs of good domestic capacitor makers. But high quality domestic capacitors are often just a bit too big to fit in the space available.

What's the answer? Search the town for another "little-bitty" original capacitor? Tell your customer you can't finish the job?

Don't give up. We have a few suggestions.

First, try a Mallory TT aluminum electrolytic. This is a real quality capacitor, rated 85°C, and it's pretty doggone small. Or a Mallory MTA, a revolutionary molded case aluminum electrolytic with excellent quality at low price.

If neither of these will fit, try a Mallory tantalum capacitor. The TAS solid tantalum is about the same size as the TT, but it's rated 125°C. Need still smaller size? Take a look at the Mallory "wet slug" tantalum types TAP and TLS—and the super-miniature MTP, which gives you the most microfarads in the smallest size of anything on the market. The pictures at the left show you comparative sizes, all for a 10 mfd, 25 WVDC rating.

Sure, you'll pay a little more for the tantalum capacitor. But not as much as you might think. The TAP only costs 42c more than the TT, in the rating shown. And you get the utmost in reliability.

We certainly don't expect you to use a tantalum capacitor to replace every aluminum electrolytic. But they come in mighty handy sometimes. And you can get them when you need them from your Mallory Distributor. Ask him for our latest catalog, or write to Mallory Distributor Products Company, a division of P. R. Mallory & Co. Inc., Indianapolis, Indiana 46206.

DON'T FORGET TO ASK 'EM—*What else needs fixing?*

Circle 111 on reader's service card

NOW

FROM



A Complete Automotive and Ignition Tune-Up System



MARK TEN

Capacitive Discharge Ignition System

\$44⁹⁵ Assembled

\$29⁹⁵ Kit Form

Get mileage you never dreamed of! 3 to 10 times spark plug life. Instant starts in all weather. Installs in only 10 minutes. Up to 20% gas savings. Dramatic increase in engine performance and acceleration.

2 NEW AUTO TUNE UP INSTRUMENTS



DWELL
METER
\$12.95
Ppd.



TACH
METER
\$14.95
Ppd.

These two new cousins to the world famous proven MARK TEN now give you the capability to tune your own car inexpensively, easily, with remarkable precision. These separate instruments are low cost, portable and the easiest to read you've ever seen.

- Delta's famous printed circuit design
- Superior in precision, quality and performance to instruments selling for FIVE TIMES as much
- Large dial, high quality jewel D'Arsonval meters
- Operates with standard, transistor or capacitive discharge systems as well as magnetos
- Instant readings — no confusing scales

Send Your Order Today



DELTA PRODUCTS, INC.

P.O. Box 1147 RE • Grand Junction, Colo.

Enclosed is \$_____. Ship prepaid.

Ship C.O.D.

Please send:

Dwell Meters @ \$12.95

Tach Meters @ \$14.95

Mark Tens (Assembled) @ \$44.95

Mark Tens (Delta Kit) @ \$29.95

(12 volt positive or negative ground only)

SPECIFY — Positive Negative
 6 or 12 Volt

Car Year _____ Make _____

Name _____

Address _____

City/State _____ Zip _____

NEW PRODUCTS continued

crystal lattice filter. Frequency synthesizer. Sensitivity less than 0.5 μ V for 10 db S/N ratio; squelch adjustable to 1 μ V. Automatic noise limiter. 100% modulation of driver and rf power amplifier; noise-cancelling microphone. Rf output 3.2 W. Push-to-talk operation. Converts to 3.5W PA system. 12-Vdc negative- or positive-ground power supply. Optional 117-Vac power supply (model 791). Military-type modular PC construction. 8 x 3 x 8 $\frac{1}{2}$ in., 7 lb. Wired only, \$189.95.—EICO Electronic Instrument Co., Inc.

Circle 52 on reader's service card

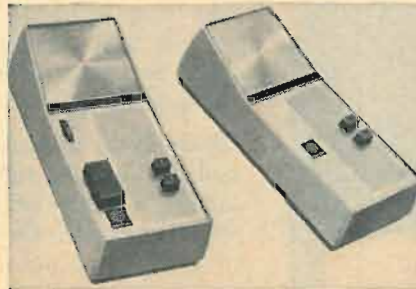

2-STATION INTERCOM, model FIC-3. Output 2W. Heavy-duty transistorized circuitry, pushbutton operation. FI-3 master unit and FIC indoor remote station with 50 ft of 3-conductor cable. A second remote station, either indoor or outdoor, may be added. Sealed, self-cleaning French Isostat switches, silvered contacts. Power supply is separate. Can be powered by external battery. Indoor remote station has "beep" signal to call master unit and a "privacy" button. In private operation, remotes cannot be monitored. For desk or wall. Model FID outdoor remote station and other accessories optional.—Fanon Electronic Industries, Inc.

Circle 53 on reader's service card



CB TRANSCEIVER, the Messenger 300. 12-channel, solid-state. Precision crystal filter in receiver reduces adjacent-channel interference. Multistage noise-limiting circuit; speech compression in transmitter; plug for Tone Alert selective-calling system. 12-Vdc operation. Mobile mounting bracket. Push-to-talk microphone and crystals for 1 channel. Two accessory power supplies enable unit to be used as base station or portable unit. \$189.95.—E. F. Johnson Co.

Circle 54 on reader's service card

SOLID-STATE HI-FI RECEIVERS, the Nocturne Two Hundred, Two Ten, and Seven Twenty (shown). New MOS FET front ends. Tuning scale, meter and



stereo indicator all light up when receiver is on, disappear behind panels when off. *Two Hundred* is an FM stereo receiver, 50 watts IHF; *Two Ten* an FM stereo/AM 50-watt receiver; *Seven Twenty* an 80-watt FM stereo receiver. *Seven Twenty's* usable FM sensitivity, 1.8 μ V. Frequency response: 5–60,000 Hz at 1 watt, 8–40,000 Hz at full power. Push-button on-off, tape monitor, tone-control defeat, scratch, rumble, interchannel muting and contour switches, headphone jack; 2-system stereo-speaker selector. *Two Hundred, Two Ten* have switches for stereo in 2 rooms separately or simultaneously. All-transistor.—Harman-Kardon, Inc.

Circle 55 on reader's service card



SOUND COLUMN, No. 3113. Range 50–18,000 Hz. 3 woofers, 1 tweeter in line arrangement. Power capacity 50 watts. Sound spread over wide area, both vertical and horizontal; gives constant audio level. Adjustable impedances with built-in transformer 16–500 ohms.—Audio Div., American Gelsco Electronics, Inc.

Circle 56 on reader's service card



BREADBOARDING, IC KITS, cover Series 74 TTL, Series 73 DTL digital logic circuits, Series 72 operational amplifiers. Include variety of basic IC's as well as breadboarding sockets. Sample diagrams for converter, counter, adder, amplifier applications; device data; catalog of more than 125 digital and linear circuits. Two of kits contain 7 and 8 IC's each, 4–6 breadboard sockets. Third kit, 4 amplifier circuits, 2 sockets.—Texas Instruments Inc., Semiconductor-Components Div.

Circle 57 on reader's service card

HEAVY-DUTY CCTV CAMERA, model MCT-15. High-sensitivity vidicon tube; simultaneous rf, video output. Solid-state. Automatic adjustment to changing light conditions. Equipped with f1.8 lens. Picture resolution 550 lines. Tube life expectancy 3,000 hr or more. Intercom jack for 2-way audio communication. Circuitry automatically adjusts to changes in line voltage. Scanning frequency: horizontal, 15,750 Hz; vertical, 60 Hz. Scanning sys-

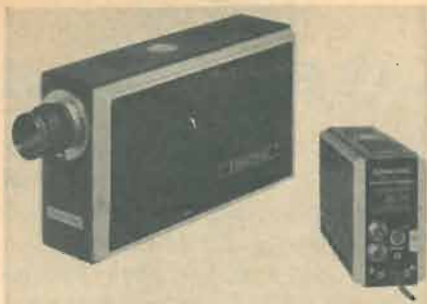

tem: random interlace; synchronizing system: synchronous to ac power line. Video bandwidth: 6 MHz. Rf carrier frequency: 76-88 MHz (tunable to channels 5, 6). Output impedance: 75 ohms; output voltage: rf, 30 mV; video, 1.4V. Power requirements: 105-130V, 60 Hz, 5 watts. 3 x 5 x 9½ in. 6 lb.—Concord Electronics Corp.

Circle 58 on reader's service card

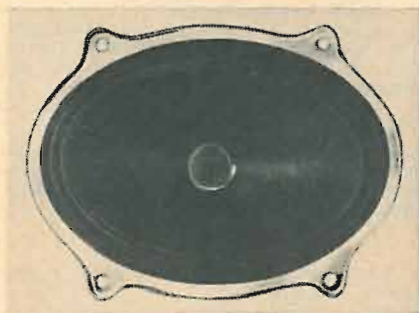

AUTO REPLACEMENT SPEAKERS, new series in 5 x 7-in. and 6 x 9-in. sizes. Model 57CMS-7, 1.47-oz magnet, 5W; model 57EVS-7, 2.15-oz magnet, 6W; model 69EVS-7, 2.15-oz magnet, 8W; model 69FOS-7, 3.16-oz. magnet, 8W; Model 69F3S-7, 4-oz ceramic magnet, 8W. All 5 models have 8-ohm voice coils.—Oxford Transducer Co.

Circle 59 on reader's service card



SUPERCARDIOID MICROPHONE, the RE15, for professional applications. Frequency response virtually independent of angular location of sound source. Sound rejection up to 26 dB at 150° off axis. Internal mechanical-nesting construction, Acoustalloy diaphragm. Frequency response 60-15,000 Hz; output level -55 dB. "Bass tilt" switch. High-quality broadcast-type cable, model 310 stand clamp. Steel case, satin-nickel finish. \$153—Electro-Voice, Inc.

Circle 60 on reader's service card

COLOR TEST ADAPTER, model 2712, for measuring cathode current of 6JS6 and 6JM6 horizontal output tubes. Alligator test leads run from interrupted

WHY risk your reputation with "just-as-good" capacitors?

When you pay little or no attention to quality in tubular replacement capacitors, you leave yourself wide open for criticism of your work . . . you risk your reputation . . . you stand to lose customers. It just doesn't pay to take a chance on capacitors with unknown or debatable performance records when it's so easy to get guaranteed dependable tubulars from your Sprague distributor!

There's no "maybe" with these 2 great SPRAGUE DIFILM® TUBULARS!

The ultimate in tubular capacitor construction. Dual dielectric . . . polyester film and special capacitor tissue . . . combines the best features of both. Impregnated with HCX®, an exclusive Sprague synthetic hydrocarbon material which fills every void in the paper, every pinhole in the plastic film *before it solidifies*, resulting in a rock-hard capacitor section . . . there's no oil to leak, no wax to drip. Designed for 105°C (220°F) operation without voltage derating.

DIFILM® ORANGE DROP® Dipped Tubular Capacitors



A "must" for applications where only radial-lead capacitors will fit . . . the perfect replacement for dipped capacitors now used in many leading TV sets. Double-dipped in rugged epoxy resin for positive protection against extreme heat and humidity. No other dipped tubular capacitor can match Sprague Orange Drops!



DIFILM® BLACK BEAUTY® Molded Tubular Capacitors

The world's most humidity-resistant molded capacitors. Tough, protective outer case of non-flammable molded phenolic . . . cannot be damaged in handling or installation. Black Beauty Capacitors will withstand the hottest temperatures to be found in any TV or radio set, even in the most humid climates.

For complete listings, get your copy of Catalog C-617 from your Sprague distributor, or write to Sprague Products Company, 81 Marshall Street, North Adams, Massachusetts.



WORLD'S LARGEST MANUFACTURER OF CAPACITORS

65-6110 R1

Circle 114 on reader's service card

NEW PRODUCTS continued



pin 2 of adapter. Unit installs between tube and tube socket. \$3.95.—Pomona Electronics Co., Inc.

Circle 61 on reader's service card



CB MOBILE ANTENNA, the MACH III. Spiral, printed-circuit coil, water proofed, shock-suspended. Wing-shaped ornamental base made of tough plastic of type used in auto racing bodies; black satin finish, silver trim. Mounted with or without shock spring. Dc-grounded, essentially flat at center frequency, SWR 1.3:1 across band. 32-in. stainless-steel whip may be bent in circle without setting. Base adjustment for tuning.—The Antenna Specialists Co. END

Circle 62 on reader's service card

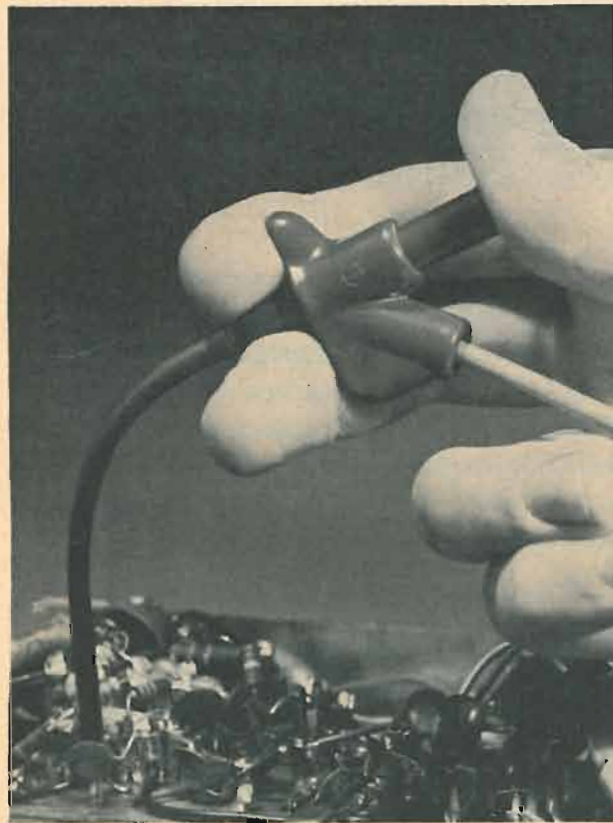

Clever Kleps 30

Push the plunger. A spring-steel forked tongue spreads out. Like this  Hang it onto a wire or terminal, let go the plunger, and Kleps 30 holds tight. Bend it, pull it, let it carry dc, sine waves, pulses to 5,000 volts peak. Not a chance of a short. The other end takes a banana plug or a bare wire test lead. Slip on a bit of shield braid to make a shielded probe. What more could you want in a test probe?



\$1.47



Available through your local distributor, or write:

RYE INDUSTRIES INC.
119 Spencer Place, Mamaroneck, N.Y. 10543

Circle 115 on reader's service card

NEW LITERATURE

All booklets, catalogs, charts, data sheets and other literature listed here are free for the asking with a Reader's Service number. Turn to the Reader's Service Card facing page 72 and circle the numbers of the items you want. Then detach and mail the card. No postage required!

ELECTRONIC TEST ACCESSORIES CATALOG, General Catalog 11-66. 31 pages, looseleaf-punched. Alphabetical-numerical index. Illustrations, diagrams, specs, applications.—Pomona Electronics Co., Inc.

Circle 63 on reader's service card

2-WAY RADIO BROCHURE, Instant Communications for Your Men on Foot. Information on HT series Handie-Talkie 2-way radios. Description, illustrations, applications, accessories.—Motorola C & E, Inc.

Circle 64 on reader's service card

DATA SHEET ON HAND-SIZE VOM, No. 71066-R, 2 pages, looseleaf-punched. Describes battery-operated model 666-R vom. Photos, specifications.—Triplett Electrical Instrument Co.

Circle 65 on reader's service card

DYNAMIC MICROPHONE FREQUENCY-RANGE CHARTS, How the Sonotone Microphone Covers the Range of Audible Sound. 2-color charts illustrate frequency ranges of 3 latest dynamic microphones. 3-hole-punched. 11 x 16 1/4 in.—Sonotone Corp.

Circle 66 on reader's service card

TOOL CATALOG, No. 266, Tools for Electronic Assembly and Precision Mechanics, 58 pages, handbook size. Describes over 1,500 items. Special solder section. 4 pages of technical information on tool selection.—Jensen Tools and Alloys

Circle 67 on reader's service card

SEMICONDUCTOR DIODE TABULATION, 18th edition of Semiconductor Diode and SCR Characteristics Tabulation. Contains complete product line of 142 manufacturers. Technical information on approximately 50,000 electronic devices. Type numbers and major characteristics.—D.A.T.A., Inc.

Circle 68 on reader's service card

1967 TEST EQUIPMENT CATALOG, 16 pages. Illustrates complete line of test and repair instruments. Tube testers, solid-state color generator, vtvm, vom, component substitutor, CRT tester-activator, in-circuit capacitor tester, signal generator. Includes wire-it-yourself kits.—Mercury Electronics Corp.

Circle 69 on reader's service card

COLOR RECEPTION AID, 16-page booklet to help boost antenna rotor sales. Explains non-technically how color TV and FM reception can be boosted with a rotor. Excellent handout piece.—Cornell-Dubilier

Circle 70 on reader's service card

Write direct to the manufacturers for information on the items listed below:

FET REFERENCE GUIDE, the FET Fact File, 250 pages in file folder. Complete, up-to-date FET reference material. Application notes, circuit ideas, performance data and design curves, reliability data, detailed specifications. \$5.—Texas Instruments Inc., P.O. Box 5012, Dallas 22, Texas

END

A SIMPLE WINDING AID FOR TOROIDS

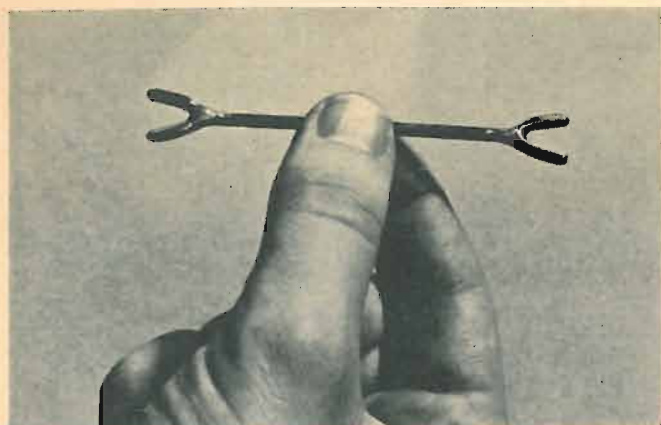

HAVE YOU EVER TRIED HAND-WINDING A TOROID BY REPEATEDLY pulling long lengths of wire through the center hole of the toroid's core? If you have, you will certainly appreciate the double-ended "witching stick" shown above. It is a simple shuttle which will vastly simplify the laborious process of hand-winding toroidal transformers and inductors.

You can make the shuttle from a steel coat hanger. Cut the shuttle's three pieces to size, scrape off the paint, bend the pieces as shown, and solder. The soldering can be simplified by carefully pinning the pieces to a length of wood covered with aluminum foil. Make your shuttle to fit the size of toroid core you are using. The device in the photo has an overall length of $3\frac{1}{4}$ inches with forks about $\frac{3}{8}$ inch wide. It was designed for cores with an inside diameter of $1\frac{1}{16}$ inch. After soldering the pieces, use a small file and emery paper to smooth all sharp edges . . . and it's finished!

To use the winding aid, merely wrap the necessary length of wire about the tines and pass the whole shuttle assembly

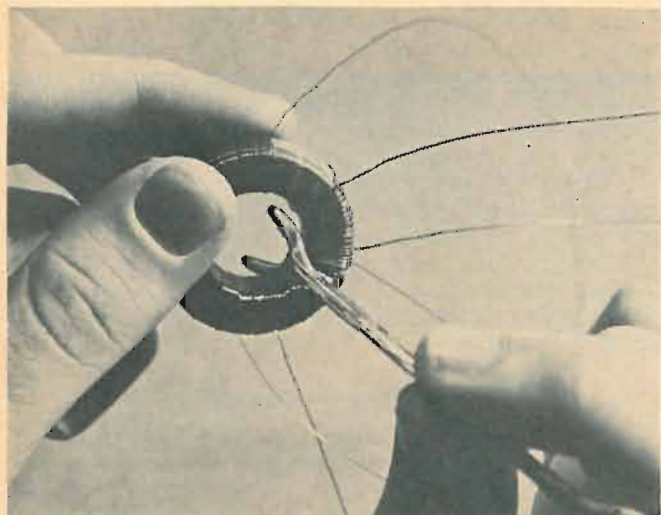

about the core as shown in the second photo. Bifilar-wound coils can also be made by simultaneously winding two lengths of wire on the shuttle. With this device, neater coils can be made in less time with less chance of wire kinks, snags and snarls.—Donald Null

END

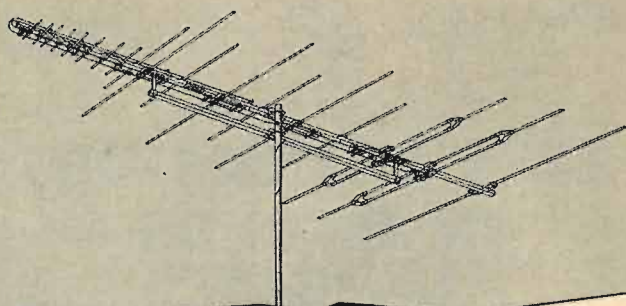

3-Way Combination FREE SPACE STANDING WAVE MAGNETIC ANTENNA

ZEROS IN
YOUR SIGNAL—

Discriminates Between
Desired Signal and
Unwanted Noise!

Here is an antenna with the unique ability to discriminate between the desired signal and unwanted noise! A complete absence of minor lobes and an extremely high front to back ratio are characteristics of these antennas. This is made possible by the development of the Free Space Standing Wave Magnetic Drive Antenna system (F.S.M.). The outstanding electrical qualities, combined with the simplified mechanical construction of this system yields a total performance package unparalleled in today's market. 4 models, 60-inch to 180-inch boom, all modestly priced.

UNEXCELLED!

UHF — VHF — FM — COLOR

INVESTIGATE NOW!

S&A Electronics Inc.

Manufacturers of the TARGET ANTENNA

210 West Florence Street
Toledo, Ohio 43605



TEST TRANSISTORS IN SECONDS in circuit

TR139
89⁵⁰



Also check all
transistors, diodes,
and rectifiers out
of circuit for true AC beta
and Icbo leakage.

Your best answer for solid state servicing, production line testing, quality control and design.

Sencore has developed a new, dynamic in-circuit transistor tester that really works—the TR139—that lets you check any transistor or diode in-circuit without disconnecting a single lead. Nothing could be simpler, quicker or more accurate. Also checks all transistors, diodes and rectifiers out of circuit.

BETA MEASUREMENTS—Beta is the all-important gain factor of a transistor; compares to the gm of a tube. The Sencore TR139 actually measures the ratio of signal on the base to that on the collector. This ratio of signal in to signal out is true AC beta.

ICBO MEASUREMENTS—The TR139 also gives you the leakage current (Icbo) of any transistor in microamps directly on the meter.

DIODE TESTS—Checks both rectifiers and diodes either in or out of the circuit. Measures the actual front to back conduction in micro-amps.

COMPLETE PROTECTION—A special circuit protects even the most delicate transistors and diodes, even if the leads are accidentally hooked up to the wrong terminals.

NO SET-UP BOOK—Just hook up any unknown transistor to the TR139 and it will read true AC beta and Icbo leakage. Determines PNP or NPN types at the flick of a switch.

Compare to laboratory testers costing much more. . . \$89.50

See America's Most Complete Line of Professional
Test Instruments — At Your Distributor Now.



NO. 1 MANUFACTURER OF ELECTRONIC MAINTENANCE EQUIPMENT

SENCORE

426 SOUTH WESTGATE DRIVE, ADDISON, ILLINOIS 60101

Circle 117 on reader's service card

TECHNOTES

G-E TB CHASSIS—AUDIO DISTORTION

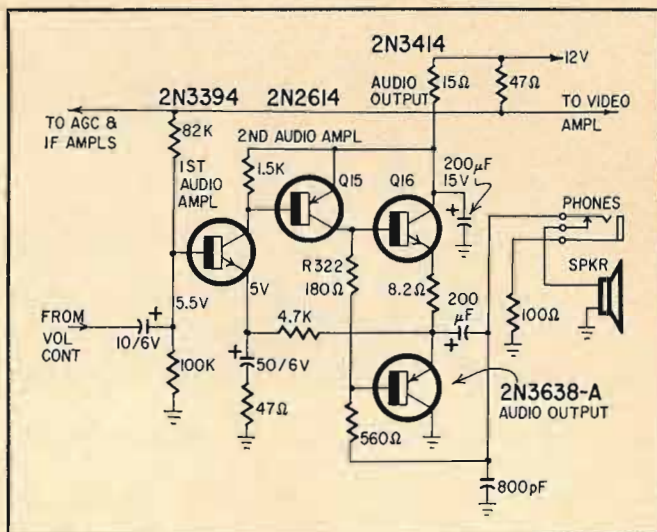

Audio distortion, resembling a raspy speaker, may be caused by crossover distortion in Q15 and Q16 due to component tolerance buildup. To correct this trouble, replace R322 (180 ohms, 10%) with a 220-ohm 10% ½-watt resistor. If a 10% resistor is not available, select the proper value with an accurate ohmmeter. Do not exceed 240 ohms or the output transistor ratings will be exceeded.

—G-E Service Talk

VERTICAL TROUBLES—ADMIRAL C2227X

The set came in with poor vertical linearity. The picture was compressed at the bottom. The linearity control worked okay but the height control did not. Similar troubles on other sets led me to the grid circuit of the vertical output tube.

The coupling capacitor checked okay on my in-circuit capacitor checker so I directed my attention to the capacitor in series with a resistor between the grid and ground. The capacitor checked out good, so I disconnected one end so I could get at one end of the resistor with my ohmmeter. After checking the resistor I, as a matter of course, touched the ohmmeter prods to the capacitor. The pointer climbed to 10 megohms and stopped. The capacitor was leaky.

After the capacitor was replaced, there was plenty of range in the height and linearity controls, and I was able to get a perfect circle on a test pattern.

This job taught me a lesson. In-circuit capacitor testers are useful but not infallible—particularly in high-impedance circuits. Now, I always lift one end of a capacitor before testing.—Alvin Dargel

G-E SB AND SC CHASSIS

Buzz, distortion and narrow sound-tuning range can be caused by a poorly crimped seam on the shield can for the sound i.f. interstage transformer (L301) or the quadrature coil (L302). A poor crimp can cause circuit detuning that varies with heat, age and looseness of the crimp.

Prior to sound alignment, and in all complaints involving these sound problems, run a bead of solder along the seam on the cans of L301 and L302. These shield-can seams are soldered in late production models.—G-E Service Talk

END

Measure Power of Electronic Flash

Have you ever wondered whether or not your electronic flash unit was delivering its rated light output? Here is a method by which you can determine its actual performance in watt-seconds (or joules), using only a 10,000-ohm 10-watt resistor and either an electronic voltmeter or a 20,000 ohms-per-volt meter with a 500-volt scale.

Before you start, remember that even the smallest electronic flash units operate at lethal voltages and unless you have had some experience with comparable equipment such as high-fidelity amplifiers and tuners, don't read any further. Many photographers, however, are also electronic equipment hobbyists and have had experience building amplifiers and tuners either from schematics or from kits, and it is to this group that the following information is directed.

The first step in determining the energy-storage capacity of your electronic flash unit is to measure the high-voltage energy-storage capacitors themselves. If you have a large flash unit with a detachable head, or with a two-terminal outlet for a second head, this step is relatively easy. If you have to open the case to get at the high-voltage capacitor terminals, it is not so convenient, but access can be had by using leads with insulated clips attached to each end. Before opening the case, make sure the storage capacitors are discharged. Turn on the unit until the ready light comes on. Turn it off, and immediately fire it. There will be some residual voltage left in the capacitors, but it should be 50 volts or less, and can be safely disposed of by shorting the terminals for a moment, using one of the clip leads. Never do this, of course, except *after* firing the unit as the full energy stored in even a small unit can fuse the clip lead and burn your fingers severely.

Now attach one clip lead to each of the two storage capacitor terminals, using a red lead for the positive terminal and black for the negative terminal. Connect a 500-volt voltmeter and resistor as shown in the diagram, leaving one terminal of the resistor open, with an insulated clip lead adjacent to the open end of the resistor. Turn the unit on and wait until the voltage stops rising. Record the observed voltage, say 450 volts. Now attach the clip lead to the open end of the 10K resistor and record the time in seconds required for the voltage to drop to 37 per cent of its initial



Here's the cardioid mike that delivers ALL the audio quality of the \$100-plus cardioids, but sells for at least \$40 less! (List price — \$59.50 everywhere.) The Turner 600 may be held by hand or stand . . . either way, you're assured of top performance, with no 'pop' and no feedback.

Whether you're buying, selling, or simply recommending cardioid microphones that are ideal for any recording job (monaural or stereo) . . . try Turner 600's first. It's the best \$100-plus microphone that \$59.50 will ever buy.



THE TURNER MICROPHONE COMPANY

933 17th Street N.E. Cedar Rapids, Iowa

In Canada: Tri-Tel Associates, Ltd.

Export: Ad Auriema Inc., 85 Broad Street, New York, N.Y. 10004



**More heat
where it counts
for greater
soldering efficiency** →

It's impossible to get the performance you expect from a soldering gun unless it converts its rated watts into heat at the tip.

Weller guns deliver the most heat per rated watt. They melt solder faster, and assure more reliable soldered connections than any other soldering guns.

For the most efficient heat, fastest heat, and exclusive trigger-controlled dual heat—insist on Weller.

Weller Dual Heat Guns and Kits come in wattage ranges from 100 to 325, priced from \$6.95 to \$12.95 list.

Weller®

WELLER ELECTRIC CORP., EASTON, PA.
In Canada: Kingston, Ontario. In England: Horsham, Sussex.
WORLD LEADER IN SOLDERING TECHNOLOGY
Circle 119 on reader's service card

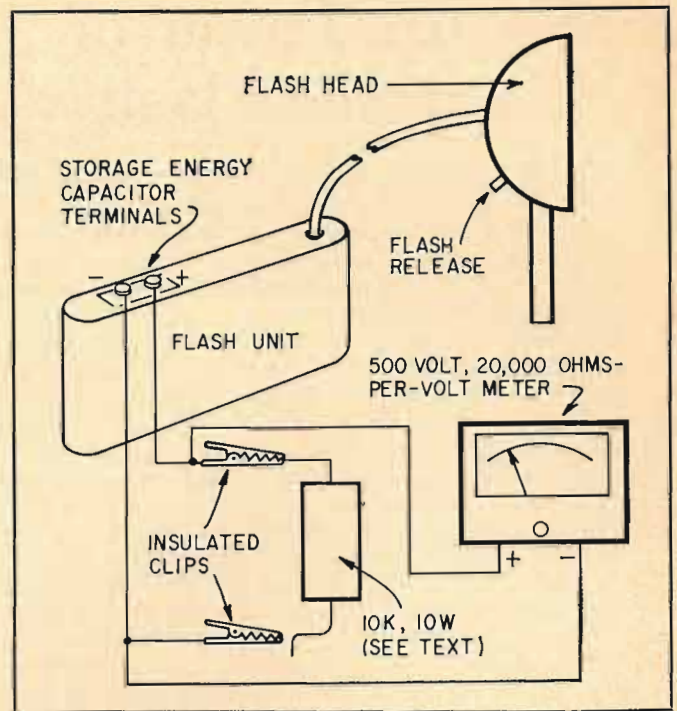

value (the voltage before the clip was attached to the resistor). You can now determine the capacitance of the energy-storage capacitors by the simple formula $T = RC$ where T is the number of seconds required for the voltage to drop to $1/\epsilon$ (37 per cent) of its initial value, R is in ohms and C is in farads (not microfarads). If the voltage was 450 at the time the resistor was connected and it dropped to $1/\epsilon \times 450$ or 165 volts in 10 seconds, then the capacitance of your energy-storage capacitor is given by $T = RC$

$$C = T/R$$

$$C = \frac{10}{10,000} = 0.001 \text{ F} = 1,000 \mu\text{F}$$

Since you now know the voltage and capacitance of your energy-storage capacitors, you can calculate the rating of your unit in watt-seconds, or joules, by using the formula:

$$WS = \frac{1}{2} CE^2$$

where WS equals watt-seconds, C equals capacitance in farads, and E is the voltage on the capacitors. Since you already know that C equals 0.001 and E equals 450, you can write

$$WS = \frac{1}{2} \times (0.001) (450)^2 = 101.5 \text{ watt seconds}$$

This is the energy stored when the discharge is initiated for firing the lamp, but is not exactly the amount of energy utilized by the lamp as there is a small residual voltage (usually about 50 volts) after the lamp has been fired. However, since the energy in watt-seconds is proportional to the square of the voltage the error is small if you neglect the residual voltage. If you want to be precise, however, you could write the energy equation above in the following form:

$$WS = \frac{1}{2} C(E_0^2 - E_r^2)$$

where E_0 is the voltage across the capacitor terminals before firing the lamp and E_r is the corresponding voltage after firing the lamp. In the example above you would find:

$$WS = \frac{1}{2} (0.001) (450^2 - 50^2) = 100.2 \text{ watt seconds.}$$

If your electronic flash unit gave the above results, you would be safe in calling it a 100 watt-second unit and in making your exposures accordingly. After completing your measurements, be sure to leave the 10,000-ohm resistor connected until the voltage in the capacitors reaches too low a value to read on the voltmeter before disconnecting your test leads and reassembling the unit.—*Nat Norman* END

IC GLOSSARY

(Relates directly to "Getting to Know IC's" on page 44)

Bistable—Describes circuit element with two stable operating states. For example, a flip-flop in which one transistor is saturated while the other is turned off. It changes state for each input pulse or trigger.

Common-mode gain—Ratio of output voltage to voltages applied to the inverting and noninverting inputs. Ideally, inputs must be equal in amplitude and phase.

Common-mode rejection—Ratio of full differential gain to common-mode gain of a differential amplifier.

Common-mode voltage gain—Ratio of signal voltage applied at the inputs (in parallel) to the signal voltage between the outputs.

Differential-input voltage range—The range of voltages that may be applied between input terminals without forcing the circuit to operate outside its specifications.

Differential voltage gain—Ratio of the change in output signal voltage at either terminal of a differential device to the change in signal voltage applied to either input terminal. All voltages measured to ground.

Fan-in—Number of inputs to a gate.

Fan-out—Number of loads that can be connected to the output of a gate.

Full adder—Circuit capable of accepting three binary input signals and producing both sum and carry output signals.

Gate—Logical device that produces a specific output for specified set of input conditions.

Half adder—Circuit that will accept two binary input signals and produce corresponding sum and carry outputs. So called because, above the first order, two half adders per order are required when adding two quantities.

Input admittance—Admittance between the input terminals with outputs shorted together.

Input common-mode rejection ratio—The ratio of change in input voltage to the corresponding change in output voltage, divided by the open-loop voltage gain. Also; the ratio of full differential voltage gain to common-mode voltage gain.

Input limiting voltage—Input signal voltage level which causes the output to drop 3 dB from its maximum level.

Input-voltage offset—The dc potential difference between the two inputs of a differential amplifier when the potential between the output terminals is zero.

Logical threshold voltage—The voltage level at the output of a logic device at which the following logic device switches states.

Offset—Measure of unbalance between halves of a symmetrical circuit. Generally caused by differences in transistor betas or in values of biasing resistors.

Open-loop bandwidth—Without feedback, the frequency limits at which the voltage gain of the device drops off 3 dB below the gain at some lower reference frequency.

Open-loop voltage gain—Ratio of the change in voltage between differential input terminals to the corresponding change in output voltage, with no feedback.

Open-loop differential voltage gain—See Differential voltage gain.

Output admittance—Admittance between output terminals with inputs shorted together.

Output saturation voltage—Lowest voltage level to which the collector of the output transistor can be reduced without degrading circuit performance.

Pull-down resistor—A resistor connected across the output of a device or circuit to hold the output equal to or less than the "O" input level of the following digital device. Also used to lower device's output impedance.

Response time—Time lapse between application of an input step function and the instant the output voltage crosses the logic-threshold voltage level.

Transadmittance—Ratio of output current to input voltage.

**BIGGER... BETTER
THAN EVER!**

FREE!



**SEND TODAY FOR YOUR NEW
40th ANNIVERSARY
1967 CATALOG**



YOUR BUYING GUIDE FOR

- Stereo & Hi-Fi Systems & Components.
- Tape Recorders.
- Electronic Parts, Tubes, Tools.
- Phonos & Records.
- Cameras and Film.
- Public Address.
- Citizens Band.
- Ham Gear.
- Transistor & FM-AM Radios.

**252 GIANT VALUE
PACKED PAGES!**

BURSTEIN-APPLEBEE CO.

Dept. RE, 1012 McGee, Kansas City, Mo. 64106
 Rush me the FREE 1967 B-A Catalog.

Name.....
Address.....
City.....
State..... Zip Code.....

Circle 120 on reader's service card

Designed and manufactured in U.S.A.

**NEVER
A BURNOUT**
IN 6 EMC DIODE-PROTECTED VOMS



NOBODY ELSE BUT EMC DESIGNS IN SO MUCH VALUE!
▪ Professional quality and versatility ▪ Lifetime protection against electrical abuse ▪ No meter burn-out, needle damage, or fuse replacement

VOLOMETER

Model 109A Factory Wired & Tested **\$28.95**
Model 109AK Easy-to-Assemble Kit **\$21.15**

20,000 Ω/v DC sens. 10,000 Ω/v AC sens. 4 1/2", 40 μa meter. High impact bakelite case. 5 DC voltage ranges: 0-6-60-300-600-3000v. 5 AC voltage ranges: 0-12-120-600-1200-3000v. 3 DC current ranges 0-6-60-600ma. 3 AC current ranges: 0-30-300ma; 0-3A. 3 resistance ranges: 0-20K, -200K, -20 megs. 5 db ranges: -4 to +67db. With carrying strap. 5 1/4" W x 6 3/4" H x 2 7/8" D.

VOLOMETER

Model 103A Factory Wired & Tested **\$20.75**

Model 103AK Easy-to-Assemble Kit **\$16.80**

4 1/2", 2% accurate, 800 μa D'Arsonval type meter. One zero adjustment for both resistance ranges. High impact bakelite case. 5 AC voltage ranges: 0-12-120-600-1200-3000v. 5 DC voltage ranges: 0-6-60-300-600-3000v. 5 db ranges: -4 to +64db. 5 AC current ranges: 0-30-150-600ma. 4 DC current ranges: 0-6-30-120ma; 0-1.2A. 2 resistance ranges: 0-1K, 0-1 meg. 5 1/4" W x 6 3/4" H x 2 7/8" D.

POCKET SIZE VOLOMETER

Model 102A

Factory Wired & Tested **\$16.95**

Model 102AK Easy-to-Assemble Kit **\$14.40**

3 1/2", 2% accurate 800 μa D'Arsonval type meter. One zero adj. for both res. ranges. High impact bakelite case. 5 AC voltage ranges: 0-12-120-600-1200-3000v. 5 DC voltage ranges: 0-6-60-300-600-3000v. 3 AC current ranges: 0-30-150-600ma. 4 DC current ranges: 0-6-30-130ma; 0-1.2A. Resistance: 0-1K, 0-1 meg. 3 3/4" W x 6 1/4" H x 2" D.

EMC, 625 Broadway, New York 12, N.Y.

Send me FREE catalog of the complete value-packed EMC line, and name of local distributor.

RE-3

NAME.....

ADDRESS.....

CITY..... ZONE..... STATE.....

EMC

ELECTRONIC MEASUREMENTS CORP.
625 Broadway, New York 12, New York

Export: Pan-Mar Corp., 1270 B'way, N.Y. 1

How To Have Fun While You Save...

NEW Harmony-By-Heathkit® Electric Guitars & Heathkit Guitar Amplifier



A Kit TA-16 \$129⁹⁵

A NEW Heathkit Transistor Guitar Amplifier — Compare It To Units Costing Several Times as Much

60 watts peak power; two channels — one for accompaniment, accordion, organ or mike — the other for special effects . . . with both variable reverb and tremolo; two 12" heavy-duty speakers; line bypass reversing switch for hum reduction; one easy-to-wire circuit with 13 transistors, 6 diodes; 28" W x 9" D x 19" H leather-textured black vinyl cabinet of 3/4" stock; 120 v. or 240 v. AC operation; extruded aluminum front panel, 52 lbs.

Famous American Made Harmony-By-Heathkit® Guitars

All wood parts factory assembled, finished and polished . . . you just mount the trim, pickups and controls in predrilled holes and install the strings . . . finish in one evening.



These Valuable Accessories
Included With
Every Guitar Kit

Each guitar includes vinylized chipboard carrying case, cushioned red leather neck strap, connecting cord, Vu-Tuner® visual tuning aid, tuning record, instruction book and pick . . . worth \$19.50 to \$31.50 depending on model.



B
Kit TG-46
\$219⁹⁵
(save \$111.55)



C
Kit TG-26
\$99⁹⁵
(save \$47)



D
Kit TG-36
\$119⁹⁵
(save \$40.55)

B Deluxe Guitar . . . 3 Pickups . . . Hollow Body Design

Double-cutaway for easy fingering of 16 frets; ultra-slim fingerboard — 24 1/4" scale; ultra-slim "uniform-feel" neck with adjustable Torque-Lok reinforcing rod; 3 pickups with individually adjustable pole-pieces under each string for emphasis and balance; 3 silent switches select 7 pickup combinations; 6 controls for pickup tone and volume; professional Bigsby vibrato tail-piece; curly maple arched body — 2" rim — shaded cherry red. 17 lbs.

C Silhouette Solid-Body Guitar . . . 2 Pickups

Modified double cutaway leaves 15 frets clear of body; ultra-slim fingerboard — 24 1/4" scale; ultra-slim neck for "uniform-feel"; Torque-Lok adjustable reinforcing rod; 2 pickups with individually adjustable pole-pieces under each string; 4 controls for tone and volume; Harmony type 'W' vibrato tailpiece; hardwood solid body, 1 1/2" rim, shaded cherry red. 13 lbs.

D "Rocket" Guitar . . . 2 Pickups . . . Hollow Body Design

Single cutaway style; ultra-slim fingerboard; ultra-slim neck, steel rod reinforced; 2 pickups with individually adjustable pole-pieces for each string; silent switch selects 3 combinations of pickups; 4 controls for tone and volume; Harmony type 'W' vibrato tailpiece; laminated maple arched body, 2" rim, shaded cherry red. 17 lbs.

NEW Heathkit®/Magnetic® 1020 4-Track Stereo Recorder Kit



Kit AD-16
\$399⁵⁰
(less cabinet)

Save \$170 By Doing The Easy Assembly Yourself.

Takes around 25 hours. Features solid-state circuitry; 4-track stereo or mono playback and record at 7 1/2 & 3 3/4 ips; sound-on-sound, sound-with-sound and echo capabilities; 3 separate motors; solenoid operation; die-cast top-plate, flywheel and capstan shaft housing; all push-button controls; automatic shut-off at end of reel; plus a host of other professional features. 45 lbs. Optional walnut base \$19.95, adapter ring for custom or cabinet installation \$4.75

NEW 12" Transistor Portable TV — First Kit With Integrated Circuit

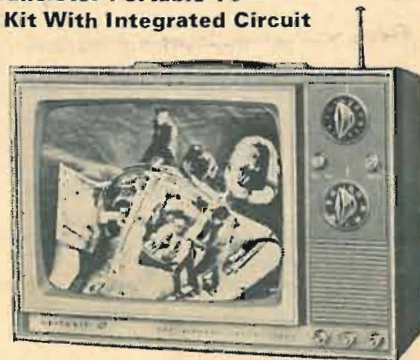

Kit GR-104
\$119⁹⁵

Plays anywhere . . . runs on household 117 v. AC, any 12 v. battery, or optional rechargeable battery pack (\$39.95). New integrated sound circuit replaces 39 TV parts; 3-stage IF for maximum gain with controlled bandwidth; gated AGC for steady, jitter-free pictures; instant "on" AC operation; preassembled & aligned tuners for peak performance; transformer-operated power supply; front panel speaker; 12-hour assembly; rugged plastic cabinet. 11 1/2" H x 15 3/4" W x 9 3/8" D. 27 lbs.

Circle 122 on reader's service card

Build Your Own Heathkit® Electronics!



23-Channel 5-Watt Transistor CB Transceiver

Assembled GWW-14

\$124⁹⁵

(Kit GW-14 \$89.95)

23 channel crystal-controlled transmit & receive. Only 2 7/8" H x 7" W x 10 1/2" D . . . ideal for car, boat, any compact installation. Front panel "S" meter, adjustable squelch, ANL, built-in speaker, PTT mike, aluminum cabinet. Operates on 12 v. DC. 8 lbs. GWA-14-1 AC power supply, 5 lbs. . . . \$14.95. GWA-14-2, 23-channel crystal pack, 1 lb. . . . \$79.95. GWA-14-4, 6 to 12 v. DC converter, 3 lbs. . . . \$14.95.



2-Watt Walkie-Talkie . . . Completely Assembled

Assembled

GRS-65A

\$99⁹⁵

Up to 6 mile inter-unit range . . . up to 10 miles with 5-watt CB base station; \$20 rechargeable battery; 9 silicon transistor, 2 diode circuit; superhet receiver with RF stage; adjustable squelch and ANL; aluminum case. 3 lbs. Optional 117 v. AC battery charger plus car cigarette lighter cord \$9.95. Crystals extra . . . \$1.99 each with order.

NEW! Deluxe Solid-State FM /FM Stereo Table Radio



Kit GR-36

\$69⁹⁵

Tuner and IF section same as used in deluxe Heathkit transistor stereo components. Other features include automatic switching to stereo; fixed AFC; adjustable phase for best stereo; two 5 1/4" PM speakers; clutched volume control for individual channel adjustment; compact 19" W x 6 1/2" D x 9 1/4" H size; preassembled, prealigned "front-end"; walnut cabinet; simple 10-hour assembly. 24 lbs.

NEW Transistor Portable Phonograph Kit



Kit GD-16

\$39⁹⁵

Worth At Least 50% More! And it sounds better. Assembles in just 1 to 2 hours . . . simply wire one small circuit board, mount the 4" x 6" speaker and plug in the preassembled changer . . . ideal beginner's kit. Features automatic mono play of all 4 speeds; dual Sapphire styli for LP's or 78's; 45 rpm adapter; olive and beige polyethylene over sturdy, preassembled cabinet. Operates on 117 v. AC. 23 lbs.

30-Watt Solid-State FM /FM Stereo Receiver

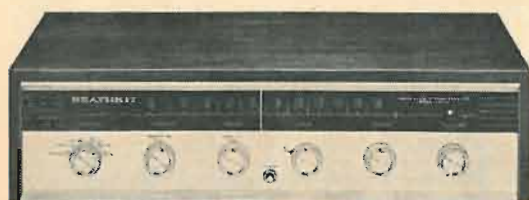

World's Best Buy In Stereo Receivers. Features 31 transistors, 10 diodes for cool, natural transistor sound; 20 watts RMS, 30 watts IHF music power @ ±1 db, 15 to 50,000 Hz; wideband FM/FM stereo tuner; plus two pre-amplifiers; front panel stereo headphone jack; compact 3 7/8" H x 15 1/4" W x 12" D size. Custom mount it in a wall, or either Heath cabinets (walnut \$9.95, beige metal \$3.95). 18 lbs.

Kit AR-14

\$99⁹⁵

(less cabinet)

NEW! Compact 2-Way 2 Speaker System With Acoustic Suspension Design

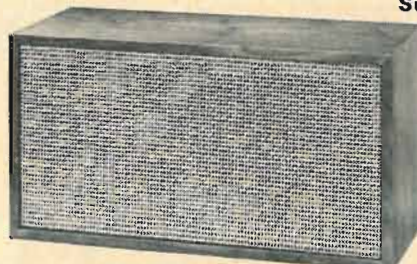

Kit AS-16

\$49⁹⁵

Handles 10 to 25 watts of program material. Features wide 45 to 20,000 Hz response; 8" acoustic suspension woofer with 6.8 oz. magnet; 3 1/2" tweeter with 4.8 oz. magnet; high frequency level control; 8 ohm impedance; 1500 Hz crossover frequency; assembled walnut veneer cabinet has scratch-proof clear vinyl covering for easy cleaning. Measures 10" H x 19" W x 8 1/2" D. Speakers are already mounted; just wire the crossover and connect cables — complete in one or two hours! 17 lbs.



FREE! World's Largest Electronic Kit Catalog!

Describes these and over 250 kits for stereo/hi-fi, color TV, amateur radio, shortwave, test, CB, marine, educational, home and hobby. Save up to 50% by doing the easy assembly yourself. Mail coupon or write Heath Company, Benton Harbor, Michigan 49022

HEATH COMPANY, Dept. 20-3
Benton Harbor, Michigan 49022
In Canada, Daystrom Ltd.



Enclosed is \$ _____, plus shipping.

Please send model (s) _____

Please send FREE 1967 Heathkit Catalog.

Name _____

Address _____

City _____

State _____

Zip _____

Prices & specifications subject to change without notice.

CL-277

FINCO

"has 'em both!"



Model #65-1
\$2995
list

Model #65-2
\$3995
list

BOOSTER COUPLERS FOR 300 OR 75 OHM

For Deluxe Home or Commercial Use

Now available for either 75 OHM CO-AX or 300 OHM operation . . . you can't beat the price, quality and performance of Finco's famous 2-tube, 4-set VHF or FM Distribution Amplifiers. Finco challenges 'em all! Equip either model with Finco low loss splitters (#3001 or #3003) and you can drive up to 16 sets in a master antenna system!

All Finco Products Are Engineered for Color!



THE FINNEY COMPANY
34 West Interstate Street, Bedford, Ohio

Circle 123 on reader's service card

INTEGRATED CIRCUIT AND MICRO-DEVICE SALE

- IC's TO-5 or all TO-46 Case, Gates, Flipflops, etc. with 8 hole test socket, 100 asstd. . . . \$10.95
- IC's Flat Packs, as above, 100 asstd. . . . \$12.50
- All IC's sample test over 50% good. Schematics, identification & test info. included.
- Hi-Gain (Darlington) Amplifier, TO-18, 4 lead Similar 2N998, Tested 6 for \$2.95
- Field Effect Trans. (FET) P channel Similar 2N3277, TO-5, 4 lead, tested 3 for \$2.95
- Chopper, NPN Hi-Speed, dual emitter TO-18 Similar 3N87, tested 6 for \$2.95
- Dual Trans. 6 lead, choice TO-18, NPN or TO-5 PNP or NPN, Diff. Amplif. Choppers, dual switches Similar 2N2980, 3726, 2060. Tested . . 6 for \$2.95
- Microcleared Relay 3/8" sq. x 1 1/4" Ax. leads, Norm. open 3000 ohm. Pick on 6V 3ma. 4 for \$2.95
- Memory Plane 5" x 8" with 4000 wired toroid bits. \$9.75. Complete 8 plane unit \$75.00
- Ultra-Tiny "Steeltab" Transistors, .060" sq. HF Amplif. & Osc. or Univ. Amplif & Switch. Elect. similar 2N913, 915, 916. choice . . . 6 for \$2.95
- Same Steeltab Diodes similar FD100 12 for \$2.95
- Above steeltabs Bubblepak indiv. cards.
- GRAND MIX Over 1000 3, 4, 6, 8, 10 lead TO-5, TO-18, TO-46, mostly Transistors, but include Darl. IC's, FETs and diodes. sample Test 50% to 90% good \$19.50

Free Goody Bag with \$10 order,
Canadian order \$10 minimum.
Calif. orders 4% sales tax.

Postage please for Amazing Free Catalog.

MIKE QUINN ELECTRONICS

Bldg. 727 Langley Street
Oakland Airport, Calif. 94614

Circle 124 on reader's service card

R-E PUZZLER

There are no ups or downs to this only-across-word puzzle but each word is connected to the word above by one letter and below by another.

- 1 Variable resistor.
- 2 Devices to oppose the flow of electric current.
- 3 Coil of wire in a transformer.
- 4 A type of negative-resistance oscillator using a 4-element vacuum tube.
- 5 Type of wire splice.
- 6 Unit used to express relative loudness of sounds.
- 7 Obsolete term for a capacitor.
- 8 Metallic element sometimes used for grid or plate electrodes.
- 9 A measuring unit for wavelength of light and other radiation.
- 10 Describing a 14-pin tube base.
- 11 Region of electrically charged air beginning about 25 miles above earth's surface.
- 12 Device in which resistance varies with applied voltage.
- 13 A 4-electrode vacuum tube.
- 14 High-resistance support or separator for conductors.
- 15 Device which increases power and/or voltage or current.
- 16 Basic two-terminal antenna.
- 17 To adjust components of a system to proper interrelationship.
- 18 Release of energy stored in a capacitor.
- 19 A thousand cycles.
- 20 Electric discharge through air.
- 21 Non-vacuum electronic devices similar in use to electron tubes.
- 22 Straight-line response to an input signal.
- 23 What causes confusion at receiver.
- 24 Converts bidirectional into unidirectional current flow.
- 25 Material having less resistance than insulator but more than metal.

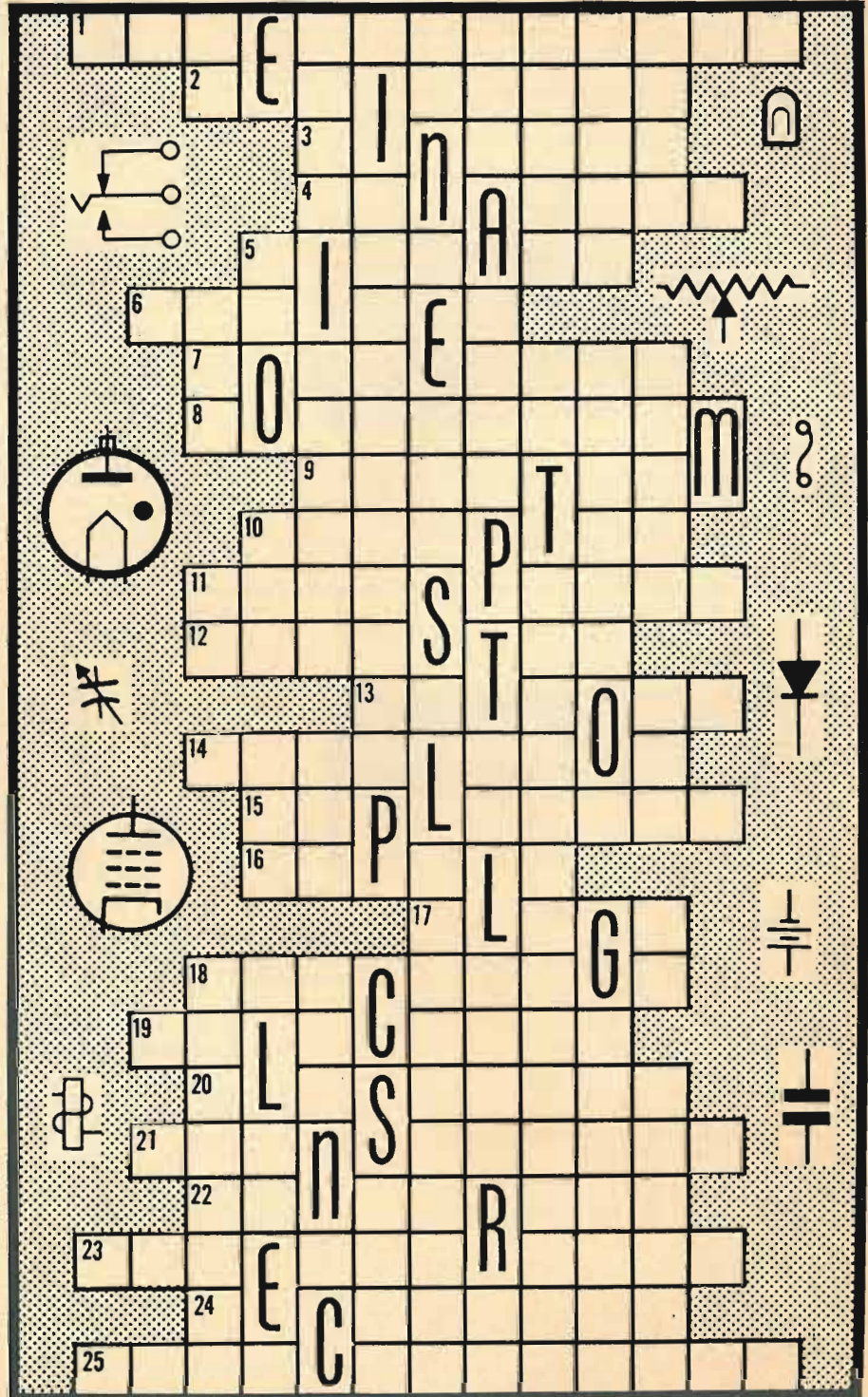

Solution next month.

WHAT'S YOUR EQ?

These are the answers.
Puzzles are on page 56.

Transistor Current

Correct answer is (1), for I_B is greater than I_E . Here's how to figure the currents:

$$I_E = \frac{E_B - E_{BE}}{R1}$$

$$= \frac{11 - 0.5}{1,000}$$

$$= 10.5 \text{ mA}$$

$$I_B = I_E + \frac{E_B - E_C - E_{BC}}{R2}$$

$$= (10.5 \times 10^{-3}) + \frac{11 - 10 - 0.5}{100}$$

$$= (10.5 \times 10^{-3}) + (5 \times 10^{-3})$$

$$= 15.5 \text{ mA}$$

Current Mystery

That portion of the autotransformer winding from B to C appears to the load as a separately wound secondary. Thus the 6-amp current flows only like this:

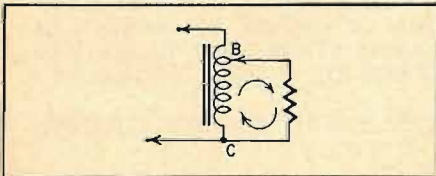

Section B to C, however, is also a portion of the primary winding, section A to C. The load requirement is 36 watts. Since the complete primary has 117 Vac across it, primary current is only 308 mA (assuming no losses in the autotransformer). END

NEW BOOKS

CREATIVE ELECTRONICS FABRICATION, by Owen G. Patrick. Holt, Reinhart and Winston, 383 Madison Ave., New York, N. Y. 10017. 6 x 9 in., 272 pp. Cloth, \$6.50

Despite the title, an immensely practical book on the mechanical procedures in building electronic devices.

Includes planning, sketching, metal working, finishing and labeling, plus assembly and wiring. One section is devoted to a step-by-step example: building a signal tracer. Section on tools crams more than ordinary amount of information into its 100 pages. Ended with an informative appendix and a fair index, this smooth-reading book should serve experimenter and prototype designer alike. END



**EFFICIENT!
SAFE!
FAST!**

AUTOMATIC STAPLE GUNS

For Fastening Any
Inside or Outside
Wire Up to 1/2" in Diameter

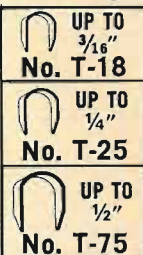

- Telephone wire
 - Intercom wire
 - Bell wire
 - Thermostat wire
 - Radiant heating wire
 - Hi-Fi, Radio & TV wires
- Tapered striking edge gets into close corners!

Available in:
Brown, Ivory, Beige,
Monel, Bronze, Natural

ARROW FASTENER COMPANY, INC.

SADDLE BROOK, N. J. 07663

Circle 125 on reader's service card

Fill in coupon for a **FREE** One Year Subscription to **OLSON ELECTRONICS' Fantastic Value Packed Catalog** — Unheard of **LOW, LOW PRICES** on Brand Name Speakers, Changers, Tubes, Tools, Stereo Amps, Tuners, CB, Hi-Fi's, and thousands of other Electronic Values. Credit plan available.

NAME _____

ADDRESS _____

CITY _____ STATE _____

GIVE ZIP CODE _____

If you have a friend interested in electronics send his name and address for a **FREE** subscription also.

OLSON ELECTRONICS, INC.

574 S. Forge Street Akron, Ohio 44308

Circle 126 on reader's service card

TWO MYSTERIES OF SCIENCE . . . lightning phenomena and UFO's will both be explored in a comprehensive article by our science editor. If you want to be prepared for strange things you may see in the sky this summer, read "Lightning, Plasmas, and Balls of Fire" in **April RADIO-ELECTRONICS**

ELECTRONICS



Engineering-Technicians

**Bachelor of Science Degree, 30 Months
Save Two Years' Time**

- Radio-Television Plus Color Technician (12 Months)
- Electronics Engineering Technology (15 Months)
- Electronics Engineering (B.S. Degree)
 - Electrical Engineering (B.S. Degree)
 - Mechanical Engineering (B.S. Degree)
 - Civil Engineering (B.S. Degree)
 - Architecture (B.S. Degree) (36 Months)

The Nation's increased demand for Engineers,

Electronic Technicians, Radio TV Technicians is at an all time high. Heald Graduates are in demand for Preferred High Paying Salaries. Train now for a lucrative satisfying lifetime career.

Approved for Veterans

DAY AND EVENING CLASSES

Write for Catalog and Registration Application.
New Term Starting Soon.

Your Name _____

Address _____

City _____

State _____



1215 Van Ness Avenue
San Francisco, California

Circle 127 on reader's service card

NEW SEMICONDUCTORS, MICROCIRCUITS & TUBES

FLAT-PACK TRANSISTORS

A recent addition to the G-E line of consumer and industrial transistors includes a series of silicon planar passivated npn transistors in flat packages

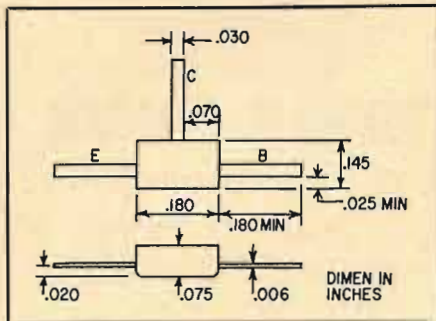

with strip-type leads as shown in the drawing. The D24A3390, D24A3390A, D24A3391 and D25A3391A are intended for low-noise preamplifier applications. They are electrical equivalents of the 2N3390, 2N3390A, 2N3391

and 2N3391A, respectively.

The D243392, -3393 and -3394 are designed as small-signal amplifiers. They feature tight beta control at extremely low price. They are the same, electrically, as the 2N3392, 2N3393 and 2N3394, respectively.

TEMPERATURE-SENSING RESISTOR

Sensistor is the name Texas Instruments applies to its line of thermistors featuring a positive temperature coefficient. The type TG 1/8 is an 1/8-watt (0.125 mW) unit in a hard-glass envelope 0.1 inch in diameter and 0.3 inch long with 1.2-inch leads. It consists of a silicon sensing element pressed between molybdenum end slugs which serve as heat sinks. Maximum power dissipation is 250 mW up to 25°C and 125 mW at 100°C ambient temperature. Standard zero-power resistance values range from 10 to 2,700 ohms in the standard EIA values for 10% tolerance resistors. TG 1/8 series Sensistors are available in 5% and 10% tolerances. END

**PERMOFLUX . . .
WILL GO TO
YOUR HEAD . . .
IF . . .**

you're seeking the ultimate in frequency response, superior engineering and durability. Write today for the dealer nearest you. A demonstration will prove to you why Permoflux headphones are used by the leading experts in all professions where sound is foremost.

All ear speakers are fully warranted for life.

STANDARD OF THE WORLD

Permoflux Corp.

P.O. Box 6364, Dept. RE 3
GLENDALE, CALIFORNIA

Circle 128 on reader's service card

48th ANNIVERSARY SALE AND OUR 20TH YEAR OF STEADY ADVERTISING IN RADIO-ELECTRONICS WITHOUT MISSING A SINGLE ISSUE — A WORTHY GUARANTEE OF VALUE & RELIABILITY —

FREE \$1 BUY WITH EVERY 10 YOU ORDER

Only applies to "\$1" Buys

FREE GIFT WITH EVERY ORDER

- | | | | |
|---|---|---|---|
| <input type="checkbox"/> 35 — BALL POINT PENS retractable, assorted colors \$1 | <input type="checkbox"/> 3—ELECTROLYTIC CONDENSERS \$1 most popular number 50/50—150v | <input type="checkbox"/> 4 — TV ALIGNMENT TOOLS \$1 most useful assortment \$1 | <input type="checkbox"/> 1 — LB SPOOL ROSIN-CORE \$1 SOLDER 40/60 top quality \$1 |
| <input type="checkbox"/> 5 — LINE FILTER COILS 115v, 2.5mb, dual, many uses . . . \$1 | <input type="checkbox"/> BONANZA "JACKPOT" not gold, not oil, but a wealth of Electronic Items—Money-Back-guarantee . . . \$5 | <input type="checkbox"/> RCA 110° FLYBACK TRANSFORMER
 We scooped the Market Latest type — standard for all 110° TV's RCA's design of large Coil produces 18KV—assuring adequate width Incl Schematic Diagram application for any TV List price \$13.90 Your price . . . \$3 10% off in lots of 3 | <input type="checkbox"/> 10 — G-E. SAPPHIRE NEEDLES \$1 4G, VR-11, etc. (\$25.00 value) . . \$1 |
| <input type="checkbox"/> 6—ELECTROLYTIC CONDENSERS 20/10mfd - 350v, 80mfd - 50v . . \$1 | <input type="checkbox"/> 75' — MINIATURE ZIP CORD 2 conductor, serves 101 uses . . . \$1 | <input type="checkbox"/> 110° TV DEFLECTION YOKE for all type TV's incl schematic \$3 same as Thordarson Y502 list \$20 | <input type="checkbox"/> 15 — G-E. #NE-2 TUBES \$1 Neon Glow Lamp for 101 uses . . \$1 |
| <input type="checkbox"/> 8 — ASST LUCITE CABINETS hinge cover, handy for parts . . . \$1 | <input type="checkbox"/> 10—ASSORTED SLIDE SWITCHES SPST, SPDT, DPDT, etc. \$1 | <input type="checkbox"/> COMBINATION SPECIAL — RCA 110° FLYBACK plus 110° DEFLECTION YOKE . . . \$5 | <input type="checkbox"/> 2 — G-E. 6X5GT TUBES brand new, individually boxed . . \$1 |
| <input type="checkbox"/> 100 — MIXED DEAL "JACKPOT" Condensers, Resistors, Surprises . . \$1 | <input type="checkbox"/> 10 SETS — DELUXE PLUGS & JACKS asst. for many purposes . . \$1 | <input type="checkbox"/> 90° FLYBACK TRANSFORMER for all type TV's incl schematic \$2 | <input type="checkbox"/> 2—G-E. PIECES OF EQUIPMENT \$1 stacked with over 200 useful parts |
| <input type="checkbox"/> 1 — SQ. YARD GRILLE CLOTH most popular brown & gold design \$1 | <input type="checkbox"/> 10 — SETS PHONO PLUGS & PIN JACKS RCA type \$1 | <input type="checkbox"/> 90° TV DEFLECTION YOKE for all type TV's incl schematic . . \$2 | <input type="checkbox"/> 10—ASSORTED DIODE CRYSTALS \$1 1N34, 1N48, 1N60, 1N64, 1N82 |
| <input type="checkbox"/> 20 — EXPERIMENTER'S COIL "JACKPOT" assorted for 101 uses \$1 | <input type="checkbox"/> 10 — SURE-GRIP ALLIGATOR CLIPS 2" plated \$1 | <input type="checkbox"/> 70° FLYBACK TRANSFORMER for all type TV's incl schematic \$1 | <input type="checkbox"/> 10—STANDARD TRANSISTORS \$1 NPN & PNP 2N404, 2N414, etc. |
| <input type="checkbox"/> 20—ASST. PILOT LIGHTS #44, 48, 47, 51, etc. \$1 | <input type="checkbox"/> 50 — RADIO & TV SOCKETS all type 7 pin, 8 pin, 9 pin, etc. \$1 | <input type="checkbox"/> 70° TV DEFLECTION YOKE for all type TV's incl schematic \$1 | <input type="checkbox"/> 25 — BENDIX CONDENSERS 007-2000v \$15 value \$1 |
| <input type="checkbox"/> 50 — ASST. DISC CERAMIC CONDENSERS popular numbers . . \$1 | <input type="checkbox"/> 200'—BUSS WIRE #20 tinned for hookups, special circuits, etc. . . \$1 | <input type="checkbox"/> 70° TV DEFLECTION YOKE for all type TV's incl schematic \$1 | <input type="checkbox"/> 5 — TOP HAT SILICON RECTIFIERS 500ma-600v top quality . . \$1 |
| <input type="checkbox"/> 10 — ASST. RADIO ELECTROLYTIC CONDENSERS \$1 | <input type="checkbox"/> 100 — STRIPS ASSORTED SPAGHETTI handy sizes \$1 | <input type="checkbox"/> 20—ASSORTED TV COILS I.F. video, sound, ratio, etc. . . . \$1 | <input type="checkbox"/> 7 — ASST. TV ELECTROLYTIC CONDENSERS popular selection . . \$1 |
| <input type="checkbox"/> 50 — ASST. TUBULAR CONDENSERS .001 to .47 to 600v . . \$1 | <input type="checkbox"/> 100—ASSORTED RUBBER GROMMETS best sizes \$1 | <input type="checkbox"/> 40—ASSORTED TV KNOBS all standard types, \$20 value . . \$1 | <input type="checkbox"/> \$15.00 TELEVISION PARTS "JACKPOT" best buy ever . . . \$1 |
| <input type="checkbox"/> 20 — STANDARD TUBULAR CONDENSERS .047-600v \$1 | <input type="checkbox"/> 50—ASSORTED PRINTED CIRCUIT SOCKETS best types . . . \$1 | | <input type="checkbox"/> \$15.00 RADIO PARTS "JACKPOT" handy assortment \$1 |
| <input type="checkbox"/> 3—1/2 MEG VOLUME CONTROLS with switch, 3" shaft \$1 | <input type="checkbox"/> 10—ASSORTED VOLUME CONTROLS less switch \$1 | | |
| <input type="checkbox"/> CLEAN UP THE KITCHEN" JACKPOT" Big Deal only one to a customer \$1 | <input type="checkbox"/> 7—ASSORTED VOLUME CONTROLS with switch \$1 | | |
| | <input type="checkbox"/> 5 — ASST. SELENIUM RECTIFIERS 65ma, 100ma, 300ma, etc. \$1 | | |

IMMEDIATE DELIVERY . . . Scientific light packing for safe delivery at minimum cost. **HANDY WAY TO ORDER:** Pencil mark or write amounts wanted in each box, place letter F in box for Free \$1 BUY. Enclose with check or money order, add extra for shipping. Tearsheets will be returned as packing slips in your order, plus lists of new offers.

Name Cost of goods
Address Shipping estimated
TOTAL

Please specify refund on shipping overpayment desired: CHECK POSTAGE STAMPS MERCHANDISE (our choice) with advantage to customer

BROOKS RADIO & TV CORP., 487 Columbus Ave., New York, N. Y. 10024

TELEPHONE 212-874 5600

Circle 129 on reader's service card

TRY THIS ONE

MIDGET SOCKET WRENCHES

Nutdrivers and socket wrenches for some of the tiny nuts used in today's electronic equipment and components are expensive and not readily available from usual sources. You can make a set of midget hexagon nutdrivers for little cost.

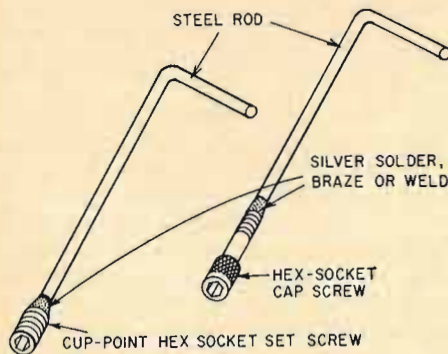

Select small cap screws and cup-point setscrews with hexagon sockets of the required sizes. Silver-solder, braze or weld them to short lengths of steel rods used as handles. The drawings show how they are made.—Paul T. Hennig END

COLOR TV & UHF GHOSTS BEWARE

of the *Brach* LATEST "GHOST ENEMY" UHF/VHF TV ANTENNAS for Black/White & Color



"GHOST ENEMY"
Model #6702
Gold Finish

Pinpoint tuning of UHF Loop with separate knob control.

Dept. Stores, Distributors & Television Manufacturers—Let us quote you on your PRIVATE BRAND requirements.

SEND FOR our latest catalog with our complete line of antennas

BRACH MFG. CORP.
Div. of General Bronze Corp.
899 Main Street, Sayreville, N.J. 08872

Circle 130 on reader's service card

CANADIANS: Ordering is easy . . . we do the paperwork . . . try a small order

SARKES TARZIAN TV TUNER 41mc



Latest Compact Model—good for all 41 mc TV's.
BRAND NEW—MONEY BACK GUARANTEE

Best TUNER "SARKES TARZIAN" ever made—last word for stability, definition & smoothness of operation. An opportunity — to improve and bring your TV Receiver up-to-date.

COMPLETE with Tubes & Schematic . . . \$7.95

HIGHWAVE AM-FM PORTABLE RADIO



Elegance in Ebony & Chrome
14 Transistors — A Powerhouse of Quality Reception with AFC Operates on 4 "C" Cells
22" Telescoping FM Antenna & Personal listening attachment
Money refund — if not better than any Known Brand selling for even twice the price
8" x 5 1/4" x 2 1/4" — 4 lbs

COMPLETE . . . \$19.50

IBM COMPUTER SECTIONS

8 assorted Units we sell for \$1 are loaded with over 150 valuable parts.
Incl. — Transistors, Condensers, Resistors, Heat Sinks, Diodes, Etc.

8 for \$1
100 for \$10

- | | | | |
|---|---|---|--|
| <input type="checkbox"/> 1000—ASST. HARDWARE KIT \$1
screws, nuts, washers, rivets, etc. | <input type="checkbox"/> 15—ASST. ROTARY SWITCHES \$1
all popular types \$20 value . . . | <input type="checkbox"/> 100—ASST 1/4 WATT RESISTORS \$1
stand. choice ohmages, some in 5% | <input type="checkbox"/> TRANSISTOR RADIO <i>asst type</i> \$1.50
good, bad, broken, as-is, potluck |
| <input type="checkbox"/> 300 — ASSORTED HEX NUTS \$1
2/56, 4/40, 5/40, 6/32, 8/32 . . . | <input type="checkbox"/> HEARING AID AMPLIFIER \$2
incl. 3 Tubes, Mike, etc. (as is) | <input type="checkbox"/> 100 — ASST 1/2 WATT RESISTORS \$1
stand. choice ohmages, some in 5% | <input type="checkbox"/> TAPE RECORDER — assorted types \$4
good, bad, broken, as-is, potluck |
| <input type="checkbox"/> 250—ASST. SOLDERING LUGS \$1
best types and sizes | <input type="checkbox"/> UNIV. 3" x 5" PM SPEAKER 75¢
Best type for Radios, TV, Etc. . . | <input type="checkbox"/> 70 — ASST 1 WATT RESISTORS \$1
stand. choice ohmages, some in 5% | <input type="checkbox"/> \$4 ELECTRIC FOOT SWITCH \$1
deluxe type for any equipment . . |
| <input type="checkbox"/> 250—ASST. WOOD SCREWS \$1
finest popular selection | <input type="checkbox"/> UNIVERSAL 4" PM SPEAKER 69¢
Alnico 5 magnet, quality tone . . | <input type="checkbox"/> 35 — ASST 2 WATT RESISTORS \$1
stand. choice ohmages, some in 5% | <input type="checkbox"/> 6 — TRANSISTOR RADIO EAR- \$1
PIECES wired complete with plug |
| <input type="checkbox"/> 250 — ASST. SELF TAPPING SCREWS \$1
#6, #8, etc. | <input type="checkbox"/> 10 — SPEAKER PLUG SETS \$1
deluxe type, 2 conductor | <input type="checkbox"/> 50 — PRECISION RESISTORS \$1
asst. list-price \$50 less 98% . . | <input type="checkbox"/> 50 — ASSORTED MYLAR CON- \$1
DENSERS popular selected types . . |
| <input type="checkbox"/> 150—ASST. 6/32 SCREWS and 150 6/32 HEX NUTS \$1 | <input type="checkbox"/> CHAPT ZU DI MITZIA "JACK- \$1
POT" double your money back if not completely satisfied | <input type="checkbox"/> 20 — ASS'TED WIREWOUND RESISTORS, 5, 10, 20 watt \$1 | <input type="checkbox"/> TELEPHONE JACK or PLUG \$50¢
make any telephone portable . . . |
| <input type="checkbox"/> 150—ASST. 8/32 SCREWS and 150—8/32 HEX NUTS \$1 | <input type="checkbox"/> 300 — ASST. 1/2 W RESISTORS \$1
Top Brand, Short leads, excellent | <input type="checkbox"/> 100 — ASST. MICA CONDENSERS some in 5% \$1 | <input type="checkbox"/> TELEPHONE RECORDING DE- \$1
VICE instant suction cup fit |
| <input type="checkbox"/> 150—ASST. 2/56 SCREWS and 150—2/56 HEX NUTS \$1 | <input type="checkbox"/> 5 — I.F. COIL TRANSFORMERS \$1
sub-min for Transistor Radios | <input type="checkbox"/> 50 — ASST. TERMINAL STRIPS \$1
all types, 1-lug to 6-lug | <input type="checkbox"/> CRYSTAL LAPEL MICROPHONE \$1
high impedance, 200-6000 cps . . |
| <input type="checkbox"/> 150—ASST. 4/40 SCREWS and 150—4/40 HEX NUTS \$1 | <input type="checkbox"/> 5 — AUDIO OUTPUT TRANS- \$1
FORM Sub-min for Trans Radios | <input type="checkbox"/> 25 — INSTRUMENT POINTER \$1
KNOBS selected popular types . . | <input type="checkbox"/> 25' — MICROPHONE CABLE \$1
deluxe, 2 conductor, shielded . . |
| <input type="checkbox"/> 150—ASST. 5/40 SCREWS and 150—5/40 HEX NUTS \$1 | <input type="checkbox"/> 4 — TOGGLE SWITCHES \$1
SPST, SPDT, DPST, DPDT | <input type="checkbox"/> 50 — ASST. RADIO KNOBS \$1
all selected popular types | <input type="checkbox"/> 50—TUBE CARTONS (colored) \$1
assorted sizes for Popular Tubes . . |
| <input type="checkbox"/> 500—ASSORTED RIVETS \$1
most useful selected sizes | <input type="checkbox"/> 70—BRASS FAHNESTOCK CLIPS \$1
popular type & size, plated | <input type="checkbox"/> 5 — PNP TRANSISTORS \$1
general purpose, TO-5 case | <input type="checkbox"/> 10 — ASSORTED TUBES \$1
Radio, Television and Industrial . . |
| <input type="checkbox"/> 500—ASSORTED WASHERS \$1
most useful selected sizes | <input type="checkbox"/> 32—TEST PROD WIRE \$1
deluxe quality, red or black | <input type="checkbox"/> 5 — NPN TRANSISTORS \$1
general purpose, TO-5 case | <input type="checkbox"/> ALL AMERICAN TUBE KIT \$2
Top Standard Brand — 12BA6, 12BE6, 12AV6, 50C5, 35W4 . . . |
| <input type="checkbox"/> 100 — ASST. RUBBER & FELT \$1
FEET FOR CABINETS best sizes | | <input type="checkbox"/> 2 — POWER TRANSISTORS No. 1 \$1
Replace 2N155, 2N176, 2N301, etc. | <input type="checkbox"/> 5 — RCA 1U4 TUBES brand new \$1
boxed, also serves as a 1T4 |

MERCHANDISE WANTED in any quantity — TUBES (all types) — RADIO & TV PARTS — EQUIPMENT finished or unfinished — immediate cash. Please send samples, quotes & amounts — only new merchandise bought.

U.S. GOV'T ELECTRONIC SURPLUS

• Nationally Known-World Famous SURPLUS CENTER offers finest, most expensive, Government Surplus electronic units and components at a fraction of their original acquisition cost.

ORDER DIRECT FROM AD or WRITE FOR CATALOGS

LABORATORY EXPERIMENTAL KIT

PERFORM 100'S OF FASCINATING ELECTRICAL EXPERIMENTS

Gov't Acquisition Cost Of Parts Over \$50.00

\$14.85
F.O.B.



• (ITEM #A222) -- Amazing Value! Valuable gift for son or husband. Hundreds of fascinating experiments. Teaches modern electronic theory and practice. Easy, interesting way to learn.

• Experiment with electro-plating, electro-magnetic phenomena, resonance, burglar alarm, relay circuits, rectification, test circuits, eavesdropping, motor experiments, transformer phenomena, etc.

• Kit Contains: DC motor, AC motor, electro-magnetic coils, ac and dc relays, set of lab capacitors, compass, test bulbs, plating chemicals, silicon diodes, germanium diode, burglar alarm actuator, carbon microphone eavesdropping element, ac test sockets, permanent magnets, telephone handset, cords, test clips, wire, and other items. Over 35 pieces, includes fine Experimental Manual with drawings, procedures, etc., written by professional engineers.

• Also furnished with each kit our popular book Home Laboratory Bench and Experimental Procedures. (Reg. \$1.00). Shows how to build wonderful home laboratory test bench, and how to get the most out of your experimental work. (12 lbs.). Parts cost gov't over \$30.00.

AC PROGRAM TIMING CLOCK

• (ITEM #158) -- Zenith 115-VAC program timer. Use for periodic signaling, work breaks, school classes, turn on radio for newscasts, etc. Adjustable clips permit switching On or Off anytime during 24-hour period. Sufficient clips for multiple programming. Also has "skip-days" feature. Contacts can handle up to 15-amps. 8 1/2" x 6 1/2" x 4". Wt. 8 lbs. Gov't Cost Over \$30.00. Instructions Furnished. F.O.B. **\$9.49**



AUTO-PILOT GYROSCOPE

• (ITEM #115) -- DC motor driven, gimbal mounted gyroscope. Ultra-expensive precision unit used to "steer" large, multi-engine planes. Deviation from established plane sends potentiometer controlled signals to bring about change in other motors. Unit can be used as autopilot for boats. Wonderful class room unit to demonstrate and study gyro action. Missiles, planes, boats all use gyros. Size 8" x 8" x 10". Wt. 21 lbs. Cost Gov't Over \$500.00.

F.O.B. **\$12.47**

STANDARD DIAL TELEPHONE

• (ITEM #715) -- Standard, commercial telephone same as used throughout U.S.A. Attractive polished black, like new condition. Use as extension phone to private systems or connect several phones together for local intercom systems. Full instructions are furnished. Wt. 9 lbs. Original Cost \$24.50. F.O.B. **\$5.95**



STEP-BY-STEP AUTOMATIC SWITCH

• (ITEM #738) -- Amazing "up-and-around" electro-magnetic telephone switch. Dial any number from 1 to 100. Make your own telephone system. Can also be used to remotely control up to 100 circuits over a single pair of wires.

• One of our FOUR STAR bargains. Comes complete with data, one dial and one line bank. Size, 5" x 7" x 15". Wt. 16 lbs. Cost Gov't Over \$75.00. Complete; Switch, cover, dial, line bank, instructions..... F.O.B. **\$9.95**



STEP UP/DOWN TRANSFORMER

• (ITEM #1543) -- Step voltage up or down. Has many uses. Will step 115-volts up to 230-volts or step 230-volts down to 115-volts. Will also transform 115-volts to 35-volts. Rated 1.75 amp. output with 175-watt capacity. Size... 4 1/2" x 2 1/2" x 2". Wt. 4 lbs. Gov't Cost \$12.75. F.O.B. **\$4.99**

TYPICAL BUYS FROM OUR 1967 CATALOGS

- \$ 350.00 - Geared 2-hp Battery Golf Car Motor **\$24.95**
- \$ 15.00 - Westinghouse DC Ammeter, 0 to 300 **\$ 7.11**
- \$ 40.00 - Vacuum/Pressure Pump, 12-VDC **\$11.95**
- - 80-MW Walkie-Talkies, Per Pair **\$19.60**
- - Deluxe, Multi-Range, AC/DC Tester **\$ 8.98**
- \$4000.00 - Carrier Telephone Amplifier System **\$13.91**

SPECIAL SALE

Correspondence Course in ELECTRICAL ENGINEERING



Sells For \$19.79 Outside U.S.A. **\$8.79** Postpaid In U.S.A.

• (ITEM #A181) -- Wonderful chance to obtain technical training at Amazing Low Cost! Lincoln Engineering School has suspended its Correspondence Courses because of increasing operating costs. We offer a limited number of the school's complete Electrical Engineering Course but without the examination paper grading system. The course consists of 14 lesson unit books. Each book has the regular exams, and in a separate section, "Standard Answers" to each exam question.

• Course is well written, easy to understand, profusely illustrated. Reader's Digest size, easy to carry and study in spare time. Many Lincoln Engineering School students holding excellent jobs as a result of L.E.S. training. Course contains latest information on transistors, silicon diodes, etc. Additional book on how to build and operate a "Home Laboratory and Experimental Bench" furnished with each course.

SEND 25c COIN OR STAMPS FOR 3 MAIN CATALOGS

All Items FOB Lincoln Money Back Guarantee

SURPLUS CENTER

DEPT. RE-037 LINCOLN, NEBR. 68501

Circle 131 on reader's service card

NOTEWORTHY CIRCUITS

A SIMPLER LIGHTS-ON REMINDER

I read with interest the article on the lights-on reminder for automobiles on page 53 of the December issue. There's an easier and less expensive way to do it. All you need is a Mallory Sonalert solid-state signal unit and a pair of inexpensive silicon diodes to get a good warning that the lights have been left on after the ignition has been turned off. In addition to the lights-on warning, you also get an audible warning when oil pressure drops below normal.

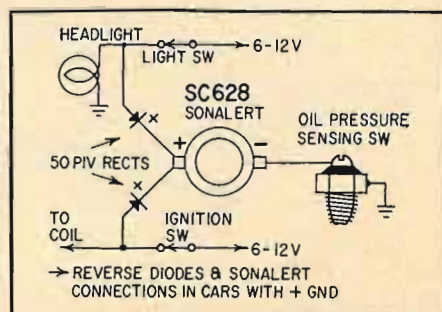

The schematic shows the hookup. The negative side of the Sonalert goes to the pressure sensor, and the positive side to the headlight and ignition circuits through the diodes. The diodes prevent the headlights from being turned on by the ignition switch and vice versa.—*Wm. F. Mullin*

TRANSISTOR VARIABLE GAIN CONTROL

When you want to control the gain of a transistor audio amplifier with a dc voltage, many disadvantages can be found in the conventional method of

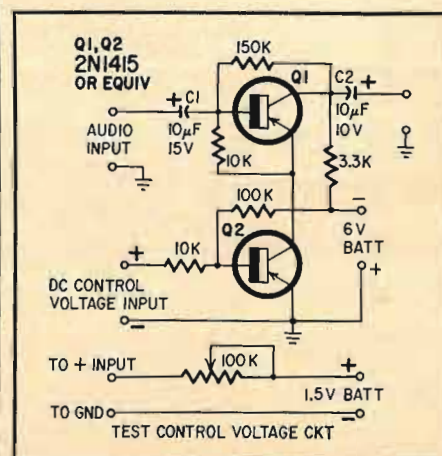

changing the bias of a transistor used as an audio amplifier. Some degree of gain control can be obtained this way but it is usually because the transistor is operating in the nonlinear portion of its characteristic curve. When a transistor is used as an audio amplifier, some distortion is usually introduced by this method.

The two-transistor circuit shown gives a good range of gain control and will add very little distortion to the signal that is being amplified.

In operation, the audio signal is fed to the base of Q1 through capacitor C1. The output signal is taken off of the collector through C2. Q1's emitter is grounded through the collector-to-emitter resistance of Q2. With little or no control voltage applied to the base of Q2, the collector-to-emitter resistance is very low and the amount of degeneration introduced into the amplifier stage (Q1) is very small. As the control voltage is increased (positive direction), the resistance of Q2 increases and more degeneration is inserted, resulting in a reduction of gain in the amplified signal.

To simulate a control voltage, a 1 1/2-volt battery and a 100K potentiometer can be connected to the input of Q2.

With an input signal of 10 mV rms (1-kHz sine wave) and zero voltage applied to the dc control input, the output is 200 mV rms, a voltage gain of 20 is obtained from the audio amplifier. As the dc control voltage is increased the gain drops to less than two without adding excessive distortion to the amplified signal.

This circuit can be used as a basic circuit for an audio volume expander, audio limiter, remote volume control, etc.—*Charles D. Rakes* END

ANTENNA PREAMPLIFIER SPECIFICATIONS

aren't always easy to understand. They will be from now on, if you read "Transistor Antenna Preamps." This important exposé of what is meant by gain, noise figure, bandwidth, and other technical jargon will be part of the Annual Spring Antenna Section in

April **RADIO-ELECTRONICS**

4 easy ways to increase your know-how on microelectronics and solid state!

How to Build Tiny Electronic Circuits

By Morris Moses. Explains "miniaturized" electronics to the hobbyist, experimenter and service technician. Not only takes the mystery out of "making it smaller", but is a veritable "how to do it" of electronic miniaturization. Covers sub-miniaturization, microminiaturization, high-frequency receiver, molecular electronics, meter amplifiers, tone generators, semiconductor thermometers, making tools, preamplifiers, comparators, pocket radios, photorelays, components, techniques, modules, practical projects and devices, construction and repair hints. 192 pages.

Order #117 Softbound \$4.15

Getting Started With Transistors

By Louis E. Garner, Jr. Transistor know-how begins with this volume. Shows how transistors began, how to read electronic diagrams, how transistors work, facts on oscillators, transistor types, diodes, phototransistors, rectifiers, transistor ratings, testing transistors. Excellent text, diagrams and photographs carry you through every phase of transistors to give you a complete grasp of the subject. 160 pages by an expert in the field.

Order #116 Softbound \$3.95

Fundamentals of Semiconductors

By M. G. Scroggie. Provides a complete background in semiconductor devices, beginning with basic facts on electrical conduction through transistors, rectifiers, photoelectric devices, thermistors, varistors, diodes, cryosars, etc. Supplies enough theory in a simple way to make it possible to understand more advanced literature. Also explains how the special properties of semiconductors are being applied in many kinds of useful devices. Dozens of charts, diagrams and photos. 160 pages.

Order #92 Softbound \$2.95

Transistors

By Editors of Radio-Electronics. Carefully selected articles from Radio-Electronics combined in a unique handbook to show you how to build all-transistor test equipment, and how to test transistors. Clear, practical know-how on power transistor tester, direct-reading transistor tester, lab type checker, mini-tracer, TV bar generator, A-I-R generator, black box oscillator, scope calibrator, kilovolt, etc. 96 pages.

Order #94 Softbound \$1.95

Order from your Parts Distributor or Mail to:

Gernsback Library Inc., Dept. RE 367
154 West 14th Street, N.Y., N.Y. 10011

Please send the following books. I enclose \$.....

117 (\$4.15) 116 (\$3.95)

92 (\$2.95) 94 (\$1.95)

Prices 10% higher in Canada.

Name

Address

City State Zip

My Distributor is

SCHOOL DIRECTORY



LEARN TECHNICAL WRITING

for prestige, high pay, advancement

WRITE YOUR WAY TO SUCCESS. Electronics, aerospace, glamour industries need trained writers now. Technical Writing is one of the highest paying careers NOT requiring college. The demand for trained writers is growing with thousands needed in all areas.

ATWS WILL TRAIN YOU AT HOME AT LOW COST. ATWS home training is fast moving, fascinating, easy-to-follow. Includes

everything you need to become a top-notch Tech Writer. Low cost. Send today for free career book and sample lesson. No salesman will call. APPROVED FOR VETERANS.

AMERICAN TECHNICAL WRITING SCHOOLS, Dept. RE-37
5512 Hollywood Boulevard, Hollywood, California 90028

GET INTO ELECTRONICS

V.T.I. training leads to success as technicians, field engineers, specialists in communications, guided missiles, computers, radar and automation. Basic & advanced courses in theory & laboratory. Electronic Engineering Technology and Electronic Technology curricula both available. Assoc. degree in 29 mos. B.S. also obtainable. G.I. approved. Graduates in all branches of electronics with major companies. Start Sept., Feb. Dorms, campus. High school graduate or equivalent. Catalog.

VALPARAISO TECHNICAL INSTITUTE
Department C, Valparaiso, Indiana



LEARN Electronics Engineering AT HOME

Fix TV, design automation systems, learn transistors, complete electronics. College level Home Study courses taught so you can understand them. Earn more in the highly paid electronic industry. Computers, Missiles, theory and practical. Kits furnished. Over 30,000 graduates now employed. Resident classes at our Chicago campus if desired. Founded 1934. Catalog. Vets—write for information about GI Bill Training.

AMERICAN INSTITUTE OF ENGINEERING AND TECHNOLOGY

1139 W. Fullerton Pky., Chicago, Ill. 60614

Get Your First Class Commercial F. C. C. LICENSE

thru spare-time study by correspondence. Our money-back warranty protects your investment. (Approved for Veterans) Write for Brochure 67. It's free.

Grantham School of Electronics
1505 N. Western Av., Hollywood, Cal. 90027

for a professional career

Tri-State graduates hold important engineering and business administration posts throughout the U. S. This professionally-oriented small college has outstanding placement record. Four-quarter year permits degree in three years. Excellent faculty. Well-equipped labs. Beautiful 300-acre campus. Accredited. Small classes. Modest costs. One-year Drafting-Design Certificate program. Enter June, Sept., Jan., March. For Catalog, write Director Admissions indicating career interest.



TRI-STATE COLLEGE

2437 College Avenue, Angola, Indiana 46703

\$\$\$ IN ELECTRICAL REPAIR!

Thousands more trained men needed every year in electrical repair. You've seen it yourself. How many times has a trained electrician repaired something in your own home for \$5, \$15, \$35! It is so easy when you know how. One of the fastest trades to learn in spare time. We give you the information to repair anything, washers, clocks, stoves, switches. Do inside and outside wiring, work on new homes. Repair power tools, telephones. Hundreds of fascinating different high paying jobs. We give you all the tools and equipment. It costs you nothing to find out! Send for big 5-piece valuable fact pack. Absolutely free. No obligation.

ITI Chicago • Los Angeles
Write Dept. 65054, 815 E. Rosecrans, Los Angeles 90059.



Learn Electronics for your SPACE-AGE EDUCATION at the center of America's aerospace industry

No matter what your aerospace goal, you can get your training at Northrop Tech, in sunny Southern California.

COLLEGE OF ENGINEERING. Get your B.S. degree in engineering in just 36 months by attending classes year round. Most Northrop Tech graduates have a job waiting for them the day they're graduated!

A & P SCHOOL. Practical experience on real aircraft. One-year course prepares you for F. A. A. A & P certificate. WRITE TODAY FOR CATALOG.

NORTHROP INSTITUTE OF TECHNOLOGY

1199 W. Arbor Vitae, Inglewood, Calif.

Huge Nationwide Demand for

DRAFTSMEN

EARN UP TO \$4.58 AN HOUR

Take your choice of thousands of big pay jobs open to Draftsmen (see high salary drafting jobs listed every day in "help wanted" sections of metropolitan newspapers). Huge nationwide demand

U. S. Dept. of Labor reports not enough applicants to fill jobs available. Our easy "Quick-Learn" Method has helped hundreds toward good income, security and prestige as draftsmen. Why not you? Leading professional draftsmen guide you step-by-step.

Spare time Home-Study Plan requires no drawing skill... many have succeeded with only grade school training. Send for FREE "DRAFTING CAREER KIT," 20-page BOOK, "Your Future in Drafting" and "SAMPLE LESSON—BOTH FREE"

NORTH AMERICAN SCHOOL OF DRAFTING

Campus Drive, Dept. 2063, Newport, Calif. 92660

TAKE YOUR PICK OF 253 COURSES

That's how many ways I.C.S. offers you to get ahead. No tricks. No gimmicks. Whatever your job interests—from accounting to zerography—there's an I.C.S. course for you. To help you get ahead faster in your present job... or find a new career. Write today for 3 FREE booklets: (1) "How to Succeed" career guide; (2) Famous Career Catalog; (3) Sample lesson to demonstrate the famous I.C.S. method, used by over 7,000,000 Americans since 1890. Send coupon NOW. No obligation.

INTERNATIONAL CORRESPONDENCE SCHOOLS

Dept. 42069B, Scranton, Penna. 18515

Accredited Member

National Home Study Council

Please send FREE success book, sample lesson and catalog checked.

- | | |
|--|---|
| <input type="checkbox"/> Accounting | <input type="checkbox"/> Elec. Eng'r/g |
| <input type="checkbox"/> Art | <input type="checkbox"/> High School |
| <input type="checkbox"/> Automobile | <input type="checkbox"/> Mech. Eng'r/g |
| <input type="checkbox"/> Business | <input type="checkbox"/> Radio-TV |
| <input type="checkbox"/> Languages | <input type="checkbox"/> Electronics |
| <input type="checkbox"/> Chemistry | <input type="checkbox"/> Secretarial |
| <input type="checkbox"/> Civil Eng'r/g | <input type="checkbox"/> Other—please specify _____ |
| <input type="checkbox"/> Drafting | |

Name _____ Age _____

Address _____

City _____

State _____ Zip Code _____

New! WICS Package for Women!

MARKET CENTER

GENERAL

CONVERT ANY TELEVISION to sensitive Big-Screen Oscilloscope. Only minor changes required. No electronic experience necessary. Illustrated plans \$2.00. RELCO-A25, Box 10563, Houston 18, Texas

TV SERVICE ORDER BOOKS for use with your rubber stamp. Duplicate or triplicate. Low cost. Write for FREE 32 PAGE CATALOG and Special Rubber Stamp Offer. OELRICH PUBLICATIONS, 6556 W. Higgins, Chicago, Ill. 60656

FREE ELECTRONICS (new and surplus) Parts catalog. We repair multimeters. BIGELOW ELECTRONICS, Bluffton, Ohio 45817

PRINTING PRESSES. Type, Supplies. Lists 5¢. TURNBAUGH SERVICE, Mechanicsburg, Pa.

New scientific transistor instrument detects buried coins, treasures. Will detect gold, silver, copper, iron, etc. \$19.95 up. Free catalog. RELCO-A-25, Box 10563, Houston 18, Texas

RADIO SUNGLASSES! WEAR AT BEACH, fishing, golf, skiing, etc. Tiny transistor radio built into frames. 3 transistors, built-in antenna, volume, station controls. Battery smaller than dime. Amazing reception. Styles for men and women. \$19.95. FEMME, 1115 Summit Ave., Union City, N.J. 07087

LAMP—APPLIANCE parts. WHOLESALE Catalogue 35¢. SECO, 109 South 20th Street, Birmingham, Alabama 35233

ZIPCODE DIRECTORY, 35,000 U.S. Post Offices \$1.00 Postpaid—Five \$4.00. ZIPCO, 7603 RE Kipling Parkway, Washington, D.C. 20028

WANTED

QUICK CASH . . . for Electronic EQUIPMENT, COMPONENTS, unused TUBES. Send list now! BARRY, 512 Broadway, New York, N.Y. 10012, 212 WALKER 5-7000

MERCURY, platinum, gold, silver. FREE circular. MERCURY REFINERS, Norwood, Mass.

WANTED: Radar Equipment AN/TPS-10D, APT-9, SCR-584, AN/GPG-1, M-33 etc., P. J. PLISHNER, 550 Fifth Avenue, N. Y. Tele: 212 JU 6-4691

WANTED: Name of manufacturer of Mark II Antitub Electronic Device. WILKEY-MOORE APPLIANCE CO., 118 S. Main, Wagoner, Oklahoma 74467

BIG CATALOG
World's "BEST BUYS"
in GOVT. SURPLUS
Electronic Equipment

TRANSMITTERS—RECEIVERS:

BC-453 Receiver—190 to 550 KC. . . . Used: \$16.95
BC-455 Receiver—6 to 9 MC. . . .
Gov't. Reconditioned, w/Dyn.: 14.95
Used: 3.95
BC-456 Modulator Used: 12.95
BC-696 Trans.—3 to 4 MC., Gov't. Recond.: 12.95
T-20 Trans.—4 to 5.3 MC. New: 9.95
T-21 Trans.—5.3 to 7 MC. New: 9.95
T-22 Trans.—7 to 9 MC. New: 18.95
BC-348 Receiver—200 to 500 KC.—
1.5 to 18 MC. Used: 69.50

NEW CATALOG—Send 25¢ (coins or stamps) & receive 50¢ credit on your order. Address Dept. RE

FAIR RADIO SALES
1016 E. EUREKA • Box 1105 • LIMA, OHIO • 45802

BLACK/WHITE OR COLOR
THE ONLY SAFE NON-DRIFT TV TUNER CLEANERS
AVAILABLE AT ALL DISTRIBUTORS
CHEMTRONICS
BROOKLYN, N. Y. 11236

SILICON RECTIFIER SALE
IMMEDIATE DELIVERY
FULLY GTD AMERICAN MADE
NEWEST TYPE FULLY TESTED

750 MA-SILICON "TOPHAT" DIODES
LOW LEAKAGE FULL LEAD LENGTH

PIV/RMS 50/35 .05 ea.	PIV/RMS 100/70 .07 ea.	PIV/RMS 200/140 .10 ea.	PIV/RMS 300/210 .12 ea.
PIV/RMS 400/280 .14 ea.	PIV/RMS 500/350 .19 ea.	PIV/RMS 600/420 .21 ea.	PIV/RMS 700/490 .25 ea.
PIV/RMS 800/560 .30 ea.	PIV/RMS 900/630 .40 ea.	PIV/RMS 1000/700 .50 ea.	PIV/RMS 1100/770 .70 ea.

ALL TESTS AC & DC & FWD & LOAD
SILICON POWER DIODE STUDS

D.C. AMPS	50 PIV 35 RMS	100 PIV 70 RMS	150 PIV 105 RMS	200 PIV 140 RMS
3	.08 ea.	.12 ea.	.16 ea.	.22 ea.
12	.25	.50	.65	.75
35	.65	.90	1.25	1.40
50	1.00	1.20	1.50	1.75
100	1.60	2.00	3.50	4.00

D.C. AMPS	300 PIV 210 RMS	400 PIV 280 RMS	500 PIV 350 RMS	600 PIV 450 RMS
3	.27 ea.	.29 ea.	.37 ea.	.45 ea.
12	.90	1.30	1.40	1.65
35	2.00	2.35	2.60	3.00
50	2.20	3.25	3.50	4.00
100	3.60	4.50	5.25	7.00

"SCR" SILICON CONTROLLED RECTIFIERS "SCR"

PRV	7 AMP	16 AMP	25 AMP	PRV	7 AMP	16 AMP	25 AMP
25	.50	.75	1.00	250	1.75	2.15	2.50
50	.80	.90	1.25	300	2.00	2.40	2.75
100	.80	1.25	1.50	300	2.40	2.75	3.25
150	.90	1.60	2.00	500	3.20	3.40	3.80
200	1.25	1.80	2.25	600	3.40	4.00	4.50

SPECIALS! SPECIALS!
Westinghouse 160 AMP, 500 PIV SILICON HI-POWER
STUD RECTIFIER IN1666.
Limited quantity. \$5.10 ea. 10 for \$45.00

100 Different Precision Resistors
1/2—1—2 Watt 1/2%—1% TOL \$1.25

Asst transistor Kit. P.N.P.—N.P.N.
All popular types. Unchecked
100 for \$2.95 500 for \$9.95

Computer Grade Condenser 15,500 MFD
12 VDC American Mfg. .75 ea.

Type IN34 DIODE GLASS .07 ea 100 for \$5

Money Back guarantee. \$2.00 min. order. Include
additional \$ for postage. Send check or money
order. C.O.D. orders 25% down.

Warren Electronic Components
230 Mercer St., N. Y., N. Y. 10012 • 212 OR 3-2620

ADVERTISING INDEX

RADIO-ELECTRONICS does not assume responsibility for any errors which may appear in the index below.

Allied Radio Corp.	22
Amperex Electronic Corp.	Second Cover
Arrow Fastener Co., Inc.	91
B & K Manufacturing Co., Inc.	15
Blonder-Tongue	26
Brach Manufacturing Corp.	93
Brooks Radio & TV Corp.	92-93
Burstein-Applebee Co.	85
Capitol Radio Engineering Institute, The	18-21
Castle TV Tuner Service, Inc.	67
Centralab (Div. of Globe-Union Inc.)	14
CLASSIFIED	96-99
Cleveland Institute of Electronics	5, 28-31
Conar (Div. of National Radio Institute)	22
Cornell Electronics Co.	98
Data Corporation, The	76
Delta Products, Inc.	78
DeVry Technical Institute	7
Eastman Kodak Company	17
EICO Electronic Instrument Co., Inc. Third Cover	
Electro-Voice, Inc.	6
Electronic Measurement Corp. (EMC)	85
Finney Co.	76, 90
Gernsback Library Inc.	95
Heald Engineering College	91
Heath Company	86-89
I.E.F.E.	12
International Crystal Mfg. Co., Inc.	100
Jerrold Electronics Corporation (Distributor Sales Division)	13
Mallory Distributor Products Company (Div. of P. R. Mallory & Co., Inc.)	77
Mike Quinn Electronics	90
Music Associated	76
National Radio Institute	8-11
Olson Electronics, Inc.	91
Permoflux Corp.	92
Poly Paks	99
Quam-Nichols Co.	25
Quietrol Co.	76
Radar Devices	1
RCA Electronic Components and Devices Tubes	Fourth Cover
RCA Institutes, Inc.	62-65
Rye Industries, Inc.	80
S & A Electronics Inc.	81
Sams & Co., Inc., Howard W.	16, 68, 69
Schober Organ Corp., Inc.	75
Scott, Inc., H.H.	25
Sencore	24, 82
Shure Bros.	67
Solid State Sales	97
Sonotone Corp. (Electronic Applications Div.)	23
Sony Corp. of America	12, 27
Sprague Products Company	79
Surplus Center	94
Turner Microphone Company, The	83
United Radio Co.	99
Warren Electronic Components	96
Weller Electric Co.	84
MARKET CENTER	96-99
Chemtronics	
Edmund Scientific Corp.	
Fair Radio Sales	
TAB	
SCHOOL DIRECTORY	95
American Institute of Engineering & Technology	
American Technical Writing Schools	
Grantham School of Electronics	
Industrial Training Institute	
International Correspondence Schools	
North American School of Drafting	
Northrop College of Science & Engineering	
Tri-State College	
Valparaiso Technical Institute	

MARKET CENTER

FREE Catalog. Electronic parts, tubes. Wholesale. Thousands of items. Unbeatable prices. ARCTURUS ELECTRONICS RE, 502-22 St., Union City, N. J. 07087

TV CAMERAS, converters, etc. Lowest factory prices. Catalog 10¢. VANGUARD, 196-23 Jamaica Ave., Hollis, N.Y. 11423

5 ELECTRONICS BOOKS FOR \$3.98. Guaranteed \$16.50 Value. Grab bag of 5 Gernsback electronics books on testing, test equipment, TV, radio, hi-fi, stereo, etc. Clearance of books which sell for as high as \$4.50. Guaranteed retail value of \$16.50. Retail prices clearly printed on covers. Send check or money order to: GRAB BAG DEPT. 37, Gernsback Library, Inc., 154 West 14th Street, New York, N.Y. 10011.

UNIQUE RELAY to build variety of remote controls, model railroads, liquid level control, weather detector, burglar alarm, games, trick circuits. 20 design ideas included free. \$3.95 prepaid. Dept. B, ALCO, Lawrence, Mass.

"JAPANESE ELECTRONICS INDUSTRY" Monthly English Magazine. Sample \$1—Subscription \$10. DEE, 10639 Riverside, North Hollywood, Calif. 91602

"TAB" • SILICON ONE-AMP DIODES
Full Leads Factory Tested & Gtd! U.S.A. Mfg

Piv/Rms	Piv/Rms	Piv/Rms	Piv/Rms
50/35	100/70	200/140	300/210
.05	.07	.10	.12
400/280	600/420	800/560	900/630
.14	.21	.30	.40
1000/700	1100/770	1700/1000	2400/1680
.50	.70	1.20	2.00

*All tests AC & DC & FWD & LOAD!

1700Piv/1200Rms @ 750Ma \$1.20 @ .10 for \$10
2400Piv/1680Rms @ 750Ma \$2 @ .6 for \$11

SILICON POWER DIODES - STUDS & P.F.**

D.C. Amps	50 Piv	100 Piv	200 Piv	300 Piv
3	.10	.15	.22	.33
12	.25	.35	.55	.90
*18	.20	.30	.75	1.00
45	.80	1.20	1.40	1.90
150	1.60	2.30	3.50	4.60
240	3.75	4.75	7.75	10.45

"TAB" TERMS: Money Back Guarantee Our 22nd Year. \$2 Min. Add Shipping Charges
111 GD LIBERTY ST., N. Y. 6, N. Y.
Send 25¢ Phone: REctor 2-6245 for Catalog

RADIO & TV TUBES 33¢ each. One year guaranteed. Plus many unusual electronic bargains. Free catalog. CORNELL, 4217-E University, San Diego, California 92105

TRANSISTORS-DIODES — Components. Large selection. Write for FREE catalogue. ELECTRONIC COMPONENTS CO. Box 2902B, Baton Rouge, La. 70821

"CRYSTAL SET CONSTRUCTION" Handbook—50¢. Catalog. LABORATORIES, 12041-B Sheridan, Garden Grove, Calif. 92640

RECEIVING & INDUSTRIAL TUBES, TRANSISTORS, All Brands—Biggest Discounts. Technicians, Hobbyists, Experimenters—Request FREE Giant Catalog and SAVE! ZALYTRON, 469 Jericho Turnpike, Mineola, N.Y. 11501

GOVERNMENT SURPLUS

72 page illustrated Government Surplus Radio, Gadgets Catalog 25¢. MESHNA, Nahant, Mass.

EDUCATION/ INSTRUCTION

LEARN ELECTRONIC ORGAN SERVICING. New home study course covering all makes electronic organ including transistors. Experimental kits—schematics—trouble-shooting. Accredited NHSC-GI Approved. Write for free booklet. NILES BRYANT SCHOOL, 3631 Stockton Blvd., Dept. F, Sacramento 20, Calif.

FCC LICENSE in 6 weeks. First Class Radio Telephone. Results Guaranteed. ELKINS RADIO SCHOOL, 2603E Inwood, Dallas, Tex.

SOLDERING IRON
FAST HEAT 80 WATT
Complete with Quality Low Cost 110-120V/15A SC 95
\$149
—30 Shipp

Special!
With every \$10 Order
25¢ per tube
(No Limit) from this list:
6AG5 6SN7
6AQ5 6CB6 6S4
6AU6 6J6 6W4

Prestige & Success are yours as an ELECTRONIC EXPERT
FOR CORNELL CUSTOMERS ONLY by special arrangement with the publisher, these amazing bargains are available

COMPLETE RADIO SERVICING AND BASIC ELECTRONICS COURSE ONLY \$3.00
152 95¢ + 50¢ shipping charge

NEW PRACTICAL TV TRAINING COURSE ONLY \$3.50
152 95¢ + 50¢ shipping charge

Both above courses \$6.00

RADIO-TV TUBE TESTER
TEST AND REPAIR TV & RADIO SETS, APPLIANCES
\$2.89 plus 30¢ shipping

CORNELL

TUBES

1 YR. GUARANTEED

Mutual Conductance Lab-tested, Individually Boxed, Branded and Code Dated, Tubes are new, or used and so marked.

33¢ PER TUBE

100 TUBES OR MORE: **30¢ PER TUBE**

OZ4	6A55	6CD6	6K6	6X4	12BF6
1B3	6AT6	6CF6	6K7	6X8	12BH7
1J3/1K3	6AT8	6CG7	6Q7	7A7	12BL6
1H5	6AU4	6CG8	6S4	7A8	12BY7
1L4	6AU5	6CM7	6SA7	7B6	12C5
1T4	6AU6				12CA5
1U4	6AV6				12SN7
1X2	6AW8				12SQ7
3BZ6	6AX4				25L6
3DG4	6BA6				25Z6
5U4	6BC5	6CZ5	6SH7	7C5	35W4
5UR	6BD6	6D6	6SJ7	7N7	35Z3
5V4	6BG6	6D4	6SK7	7Y4	50L6
5Y3	6BJ6	6D4	6SL7	12AD6	24
6A6	6BL7	6D6	6SN7	12AE6	27
6AB	6BN4	6D6	6S7	12AF6	77
6AB4	6BN6	6E7	6S7	12A77	78
6AC7	6BQ6	6E7	6G7	12AU7	84/6Z4
6AG5	6BQ6	6E7	6G7	12AX7	5687
6AK5	6BQ7	6F6	6H6	12BA6	6350
6AL5	6BZ6	6GH8	6H6	12BD6	6463
6AN8	6C4	6H6	6V6	12BE6	7044
6AQ5	6C6	6J5	6W4		
	6CB6	6J6	6W6		

Other tubes at low prices—send for free list

NO SUBSTITUTIONS WITHOUT YOUR PERMISSION

21" PICTURE TUBES
139¢
Aluminized No COB's on Picture Tubes

17AVN	21CPC	21DPA
17BPA	21DPA	21DPA
17DPA	21DPA	21DPA
17DPA	21DPA	21DPA
17DPA	21DPA	21DPA
20DPA	21DPA	21DPA
20DPA	21DPA	21DPA
20DPA	21DPA	21DPA

all purpose ELECTRONIC CLEANER
89¢ plus 70¢ shipping
ELECTRONIC CLEANER
LUBRICATED RESTORES
SHRINKS & CORRECTS
CORNELL

SILICON RECTIFIERS
750 MA 69¢ plus 30¢ shipping
1000 MA 89¢ plus 30¢ shipping

DIODES / RECTIFIERS
39¢ per pack plus 30¢ shipping
sensational KIT VALUE!
This 12 pack is one of those rare electronic bargains. Each pack contains an assortment of 12 diodes—rectifiers for the hobbyist or experimenter. These diodes have all been checked for Go-No Go and the original cost ranged from \$1.00 to \$11.00 each. These are brand new diodes and were manufactured by International Rectifier Corp. A few of the numbers included are: 5A0P, 5A0P, 5A0P, 5A0P, 5A0P, 5A0P, 5A0P, 5A0P, 5A0P, 5A0P, 5A0P, 5A0P. Each pack is accompanied by an identification sheet so you can determine just which parts are included in your pack.

EPOXY DIODES
1000 MA RATING ON EACH DEVICE
79¢ per pack plus 30¢ shipping

GIANT TWIN-PACK SELF STICKING PLASTIC ELECTRICAL TAPE
12,000 VOLT INSULATION
99¢
• BLENDS
• REPAIRS
• INSULATES
• DECORATES • 12 Shipp.

CAR RADIO POWER TRANSISTORS
No. 05001 99¢ No. 2ND01A 69¢

CORNELL ELECTRONICS CO.

Dept RE 3 4217 University Ave., San Diego, Calif. 92105

Circle 138 on reader's service card

LEARN TECHNICAL WRITING—qualify at home for high paying prestige career not requiring college. Growing demand in all industries for tech writers now. Low monthly tuition. Easy to understand. FREE career book, sample lesson. AMERICAN TECHNICAL WRITING SCHOOLS, Dept. REC-37, 5512 Hollywood Blvd., Hollywood, Calif. 90028

SLEEP LEARNING. Hypnotism! Tapes, records, books, equipment. Details, strange catalog FREE. RESEARCH ASSOCIATION, Box 24-RD, Olympia, Wash.

BROADCASTING, Communications Electronics taught quickly—resident classes; correspondence. Free details. Write: Dept. 4, GRANTHAM SCHOOLS, 1505 N. Western, Hollywood, Calif. 90027

DON'T BUY TUBES!!

RADIO or T.V.-XMITTING
or SPECIAL-PURPOSE TYPES

UNTIL YOU GET OUR PRICE LIST
GUARANTEED TO BE THE
LOWEST PRICES IN THE U.S.A.
OVER 5000 TYPES—ALL 100%
GUARANTEED BRAND NEW

"WE'RE NEVER UNDERSOLD"

SEND POST CARD FOR T.V. OR
SPECIAL PURPOSE PRICE LIST

ESTABLISHED 1920

UNITED RADIO CO.

56 FERRY ST., NEWARK, N.J.
P.O. BOX 1000 - ZIP CODE - 07101

REI First Class Radio Telephone License in (5) weeks Guaranteed. Tuition \$295.00. Job placement free. RADIO ENGINEERING INSTITUTE, 1336 Main Street, Sarasota, Fla.

CORRESPONDENCE COURSES—B.Sc., Engineering, Electronics, Catalog \$1. CANADIAN INSTITUTE OF SCIENCE & TECHNOLOGY, 2636 Adelaide St. W., Toronto

WANTED! TV-RADIOMEN to learn aircraft electronics servicing. Numerous job openings everywhere. Write: ACADEMY AVIONICS, Reno/Stead Airport, Reno, Nevada

TRANSISTOR COURSE—Gain practical, broad knowledge about transistors: Principles, Construction, Specification, Application. Complete home study course. Individualized instruction. Licensed State of Pennsylvania. Free information. PRICE SCHOOL, 2710 Laurel, Dept. J., North Hills, Pa. 19038

WATCH REPAIRING. Swiss and American watches. Develop skill step by step in spare time at home. Diploma awarded. Free sample lesson. CHICAGO SCHOOL, Dept. REC, Fox River Grove, Ill. 60021

SERVICES

Transistorized products dealers catalog. \$1. INTERMARKET, CPO 1717, Tokyo, Japan.

TECH MANUALS, BOUGHT AND SOLD on military surplus and civilian electronic equipment. BILL SLEEP COMPANY, Drawer 178RE, Ellenton, Florida 33532

CLASSIFIED COMMERCIAL RATE (for firms or individuals offering commercial products or services): 60¢ per word . . . minimum 10 words.

NON-COMMERCIAL RATE (for individuals who want to buy or sell personal items): 30¢ per word . . . no minimum.

Payment must accompany all ads except those placed by accredited advertising agencies. 10% discount on 12 consecutive insertions, if paid in advance. Misleading or objectionable ads not accepted. Copy for April issue must reach us before February 10th.

WORD COUNT: Include name and address. Name of city (Des Moines) or state (New York) counts as one word each. Zone or Zip Code numbers not counted. (We reserve the right to omit Zip Code if space does not permit.) Count each abbreviation, initial, single figure or group of figures or letters as a word. Symbols or groups such as 8-10, COD, AC, etc., count as one word. Hyphenated words count as two words. Minor over-wordage will be edited to match advance payment.

CLASSIFIED ADVERTISING ORDER FORM

For complete data concerning classified advertising please refer to box elsewhere in Market Center section.

1	2	3	4	5
6	7	8	9	10
11	12	13	14	15
16	17	18	19	20
21	22	23	24	25
26	27	28	29	30
31	32	33	34	35

No. of Words { @ .30 Non-Commercial Rate } = \$
{ @ .60 Commercial Rate }

Total Enclosed \$

Insert _____ time(s)

Starting with _____ issue

Payment must accompany order unless placed through accredited advertising agency 37

NAME _____

ADDRESS _____

CITY _____ STATE _____ ZIP _____

SIGNATURE _____

MAIL TO: RADIO-ELECTRONICS, CLASSIFIED AD DEPT., 154 WEST 14TH ST., NEW YORK, N.Y. 10011

FREE!

PLUS
CHOOSE
ANY
\$100
ITEM
FREE

\$25

WORTH OF
TRANSISTORS
RECTIFIERS
RESISTORS
CONDENSERS
DIODES & ETC

Add 25¢ for handling

BOTH FREE WITH ANY \$10 ORDER

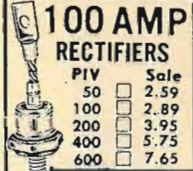

100 AMP
RECTIFIERS
PIV Sale
50 2.59
100 2.89
200 3.95
400 5.75
600 7.65



1 AMP
800 PIV
RECTIFIERS
TOP HAT \$1 for GE

1 amp

New!

SILICON CONTROLLED RECTIFIERS

PRV	3 AMP	7 AMP	16 AMP	25 AMP
50	30	48	70	90
100	50	70	1.20	1.50
200	80	1.05	1.70	2.10
300	1.05	1.60	2.20	2.70
400	1.60	2.10	2.70	3.00
500	2.10	2.80	3.30	3.80
600	2.50	3.00	3.90	4.30

\$1.98

2000 PIV

WORLD'S MOST POPULAR

\$1 PARTS PAKS

- 30 "YELLOW" MYLAR CONDENSERS, asstd val
- 60 CERAMIC CONDENSERS, discs, npo's, to .03
- 60 TUBULAR CONDENSERS, to .5mf, to 1KV, asst
- 40 DISC CONDENSERS, 27mmf to .05mf to 1KV
- 60 TUBE SOCKETS, receptacles, plugs, audio, etc.
- 30 POWER RESISTORS, 5 to 50W, to 24 Kohms.
- 65 HALF WATTERS, asst incl: A.B., 5% too!
- 60 HI-O RESISTORS, 1/2, 1, 2W, 1% & 5% values
- 10 VOLUME CONTROLS, to 1 meg, switch too!
- 10 ELECTROLYTICS, to 500mf, asst FP & tubulars
- 50 RADIO & TV KNOBS, asstd. colors & styles

Integrated Circuits

\$1.89

include Gates Buffers, Flipflops etc. Asstd. no test

FET'S "N" CHANNEL TRANSISTORS 1 for \$1. 2 for 1.01

2 AMP SILICON RECTIFIER

SALE!

- GLASS CAPS
- METALLIZED

PIV	Sale	PIV	Sale	PIV	Sale
50	7¢	600	25¢	1400	89¢
100	9¢	800	39¢	1600	1.25
200	12¢	1000	55¢		
400	19¢	1200	69¢		

Actual Size

MOTOROLA TRANSISTORS

NEW

2N1100 \$1.77
1.5 AMP VCB 100

PNP 100Watt/15 Amp Hi Power
T036 Case1 2N441, 442, 277,
278, DS501 up to 50 Volts

DC MICROAMMETERS

ONE WATT ZENER DIODES EACH

\$3.88



Volts	Volts	Volts	Volts
5.4	18	43	100
6.4	20	47	110
8.0	22	51	120
9.1	24	56	130
10	27	62	150
12	30	68	160
13	33	75	180
15	36	82	200
16	39	91	

2 1/4" 0-100

10

GIANT SPRING CATALOG ON: PARTS & RECTIFIERS TRANSISTORS SCRS ZENERS

POLY PAKS

TERMS: Send check, money order. Add postage—avg. wt. per pak 1 lb. Ret'd net 30 days. COD 25% deposit.

P.O. BOX 942R
SO. LYNNFIELD, MASS.
"PAK-KING" of the world

Circle 139 on reader's service card

INTERNATIONAL FREQUENCY METERS

designed for servicing!

Equip your lab or service bench with the finest



FM-5000 FREQUENCY METER 25 MC to 470 MC

The FM-5000 is a beat frequency measuring device incorporating a transistor counter circuit, low RF output for receiver checking, transmitter keying circuit, audio oscillator, self contained batteries, plug-in oscillators with heating circuits covering frequencies from 100 kc to 60 mc. Stability: $\pm .00025\%$ $+85^\circ$ to $+95^\circ\text{F}$, $\pm .0005\%$ $+50^\circ$ to $+100^\circ\text{F}$, $\pm .001\%$ $+32^\circ$ to $+120^\circ\text{F}$. A separate oscillator (FO-2410) housing 24 crystals and a heater circuit is available. Shipping weight: 18 lbs.

FM-5000 with batteries, accessories, less oscillators and crystals.
Cat. No. 620-103.....\$375.00

Plug-in oscillators with crystals \$20.00 to \$50.00



C-12M FREQUENCY METER For Marine Band Servicing

The C-12M is a portable secondary standard for servicing radio transmitters and receivers in the 2 mc to 15 mc range. The meter has sockets for 24 crystals. Frequency stability is $\pm .0025\%$ 32° to 125°F , $\pm .0015\%$ 50° to 100°F . The C-12M has a built-in transistorized frequency counter circuit, AM percentage modulation checker and modulation carrier and relative percentage field strength. Shipping wt. 9 lbs.
C-12M with PK (pick-off) box and connecting cable, batteries, but less crystals.
Cat. No. 620-104.....\$235.00
Crystals for C-12M (specify frequency)
\$7.00 to \$10.00



Model 7212 FREQUENCY METER

The International Model 7212 portable secondary frequency standard is a self contained unit designed for servicing radio transmitters and receivers used in the 400 kc to 500 kc range (can be modified for other frequencies on special order). Frequency accuracy is $\pm .01\%$ from 32°F to 104°F (0°C to 40°C). The meter holds eight crystals. Features include the transistorized frequency oscillator and built-in battery charger. Shipping weight: 18 lbs.
Model 7212 complete with crystals.
Cat. No. 620-105.....\$575.00



CRYSTAL CONTROLLED C-12 ALIGNMENT OSCILLATOR

The International C-12 alignment oscillator provides a standard for alignment of IF and RF circuits 200 kc to 60 mc. It makes the 12 most used frequencies instantly available through 12 crystal positions 200 kc to 15,000 kc. Special oscillators are available for use at the higher frequencies to 60 mc. Maximum output .6 volt. Power requirements: 115 vac. Shipping wt. 9 lbs.
C-12 complete, but less crystals.
Cat. No. 620-100.....\$ 69.50

**Write today for our
FREE CATALOG**

Circle 148 on reader's service card



Model 1110 SECONDARY FREQUENCY STANDARD

The Model 1110 is an economy portable secondary standard for field or bench use with self contained battery. Using any general coverage communications receiver the unit provides the necessary standard signal for measuring frequencies. Easily calibrated against WWV to provide an accuracy of 1×10^6 . Long term stability of ± 10 cycles over range 40°F to 100°F . All transistor circuits provide outputs at 1 mc, 100 kc and 10 kc. Zero adjustment for oscillator on front panel. SHIPPING WEIGHT — 12 lbs.

Model 1110 complete.
Cat. No. 620-106.....\$125.00



C-12B FREQUENCY METER For Citizens Band Servicing

This extremely portable secondary frequency standard is a self contained unit for servicing radio transmitters and receivers used in the 27 mc Citizens Band. The meter is capable of holding 24 crystals and comes with 23 crystals installed. The 23 crystals cover Channel 1 through 23. The frequency stability of the C-12B is $\pm .0025\%$ 32° to 125°F , $.0015\%$ 50° to 100°F . Other features include a transistorized frequency counter circuit, AM percentage modulation checker and power output meter. Shipping weight: 9 lbs.
C-12B with .PK (pick-off) box, dummy load, connecting cable, crystals, batteries.
Cat. No. 620-101.....\$300.00

KEEPING YOU ON FREQUENCY IS OUR BUSINESS . . .



INTERNATIONAL
CRYSTAL MFG. CO., INC.
18 NO. LEE • OKLA. CITY, OKLA. 73102

RADIO-ELECTRONICS



Introducing EICO's New "Cortina Series"!

Today's electro-technology makes possible near-perfect stereo at moderate manufacturing cost; that's the design concept behind the new EICO "Cortina" all solid-state stereo components. All are 100% professional, conveniently compact (3 1/8"H, 12"W, 8"D), in an esthetically striking "low silhouette." Yes, you can pay more for high quality stereo. But now there's no need to. The refinements will be marginal and probably inaudible. Each is \$89.95 kit, \$119.95 wired.

Model 3070 All-Silicon Solid-State 70-Watt Stereo

Amplifier: Distortionless, natural sound with unrestricted bass and perfect transient response (no inter-stage or output transformers); complete input, filter and control facilities; failure-proof rugged all-silicon transistor circuitry.

Model 3200 Solid-State FM/MPX Automatic Stereo Tuner: Driftless, noiseless performance; 2.4μV for 30db quieting; RF, IF, MX are pre-wired and pre-tuned on printed circuit boards — you wire only non-critical power supply.

7 New Ways to make Electronics more Fun!

Save up to 50% with EICO Kits and Wired Equipment.



You hear all the action-packed capitals of the world with the NEW EICO 711 "Space Ranger" 4-Band Short Wave Communications Receiver — plus ham operators, ship-to-shore, aircraft, Coast Guard, and the full AM band. 550KC to 30MC in four bands. Selective, sensitive superhet, modern printed circuit board construction. Easy, fast pinpoint tuning: illuminated slide-rule dials, logging scale; "S" meter, electrical bandspread tuning, variable BFO for CW and SSB reception, automatic noise limiter. 4" speaker. Headphone jack. Kit \$49.95. Wired \$69.95.



More "ham" for your dollar than ever — with the one and only SSB/AM/CW, 3-Band Transceiver Kit, new Model 753 — "the best ham transceiver buy for 1966" — Radio TV Experimenter Magazine. 200 watts PEP on 80, 40 and 20 meters. Receiver offset tuning, built-in VOX, high level dynamic ALC, silicon solid-state VFO. Unequaled performance, features and appearance. Sensationally priced at \$189.95 kit; \$299.95 wired.



NEW EICO 888 Solid-State Engine Analyzer

Now you can tune-up, trouble-shoot and test your own car or boat.

Keep your car or boat engine in tip-top shape with this completely portable, self-contained, self-powered universal engine analyzer. Completely tests your total ignition/electrical system. The first time you use it — just to tune for peak performance — it'll have paid for itself. (No tune-up charges, better gas consumption, longer wear) 7 instruments in one, the EICO 888 does all these for 6V and 12V systems; 4, 6 & 8 cylinder engines.

The EICO 888 comes complete with a comprehensive Tune-up and Trouble-shooting Manual including RPM and Dwell angle for over 40 models of American and Foreign cars. The Model 888 is an outstanding value at \$44.95 kit, \$59.95 wired.



New EICOCRAFT® easy-to-build solid-state electronic TruKits® great for beginners and sophisticates alike. As professional as the standard EICO line — only the complexity is reduced to make kit-building faster, easier, lower cost. Features: pre-drilled copper-plated etched printed

circuit boards; finest parts; step-by-step instructions; no technical experience needed — just soldering iron and pliers. Choose from: Fire Alarm; Intercom; Burglar Alarm; Light Flasher; "Mystifier"; Siren; Code Oscillator; Metronome; Tremolo; Audio Power Amplifier; AC Power Supply. From \$2.50 per kit.



New EICO "Nova-23" (Model 7923) all solid-state 23-channel 5-watt CB Transceiver featuring a host of CB advances — plus exclusive engineering innovations.

EXCLUSIVE dual-crystal lattice filter for advanced razor-sharp selectivity of reception.
EXCLUSIVE highly efficient up-converter frequency synthesizer provides advanced stability and freedom from trouble in all 23 crystal-controlled transmit-receive channels. All crystals supplied.
EXCLUSIVE use of precision series-mode fundamental crystals for superior transmit and receive stability. **Wired only, \$189.95**



Model 460 Wideband Direct-Coupled 5" Oscilloscope. DC-4.5mc for color and B&W TV service and lab use. Push-pull DC vertical amp., bal. or unbal. input. Automatic sync limiter and amp. \$99.95 kit, \$139.50 wired.

FREE: 1967 EICO CATALOG

EICO Electronic Instrument Co., Inc.,
131-01 39th Ave., Flushing, N.Y. 11352

Circle reader service # 149 for free catalog describing the full EICO line of 200 best buys including test equipment, stereo, Hi-Fi, automotive electronics, ham radio, citizen band radios and name of nearest dealer.



Model 232 Peak-to-Peak VTVM. A must for color or B&W TV and industrial use. 7 non-skip ranges on all 4 functions. With exclusive Uni-Probe.® \$29.95 kit, \$49.95 wired.

Circle 149 on reader's service card

Lists more than 1300 receiving tubes

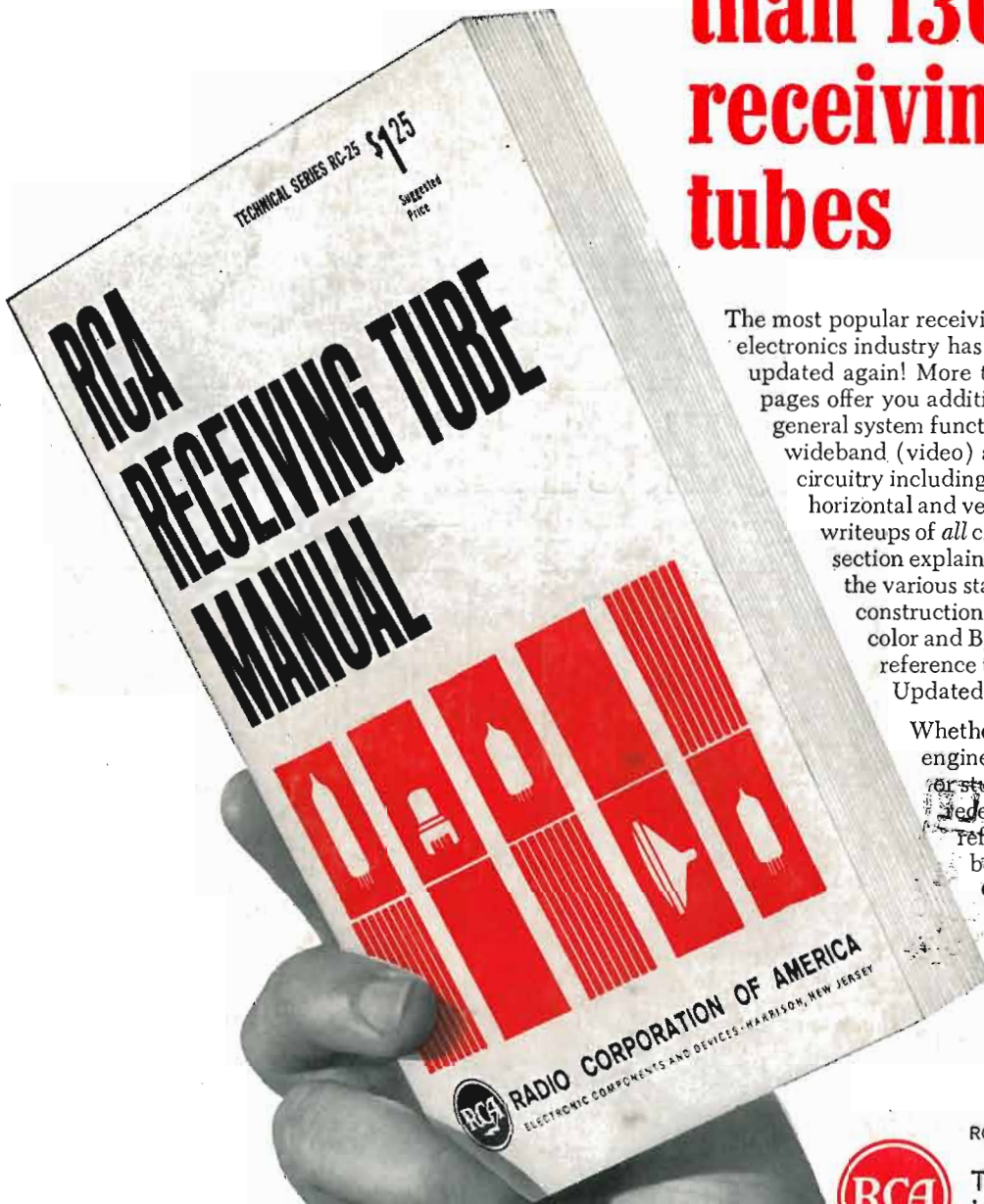

The most popular receiving tube manual in the electronics industry has been revised and updated again! More than 600 data-packed pages offer you additional text information on general system functions, tuned amplifiers, wideband (video) amplifiers, and TV circuitry including scanning, sync, and both horizontal and vertical deflection. Text writeups of *all* circuits in the circuit section explain in detail the functions of the various stages, aiding in the construction of these circuits. Data on color and B/W picture tubes, voltage reference tubes, voltage regulator tubes. Updated Applications Guide.

Whether you're a service technician, engineer, radio amateur, hobbyist or student... the new RC-25 receiving tube manual is a reference work that just has to be in your technical library. Order yours today from your nearest Authorized RCA Tube Distributor.

Only
\$1.25*
*Suggested Price

RCA Electronic Components and Devices, Harrison, N.J.



The Most Trusted Name
in Electronics